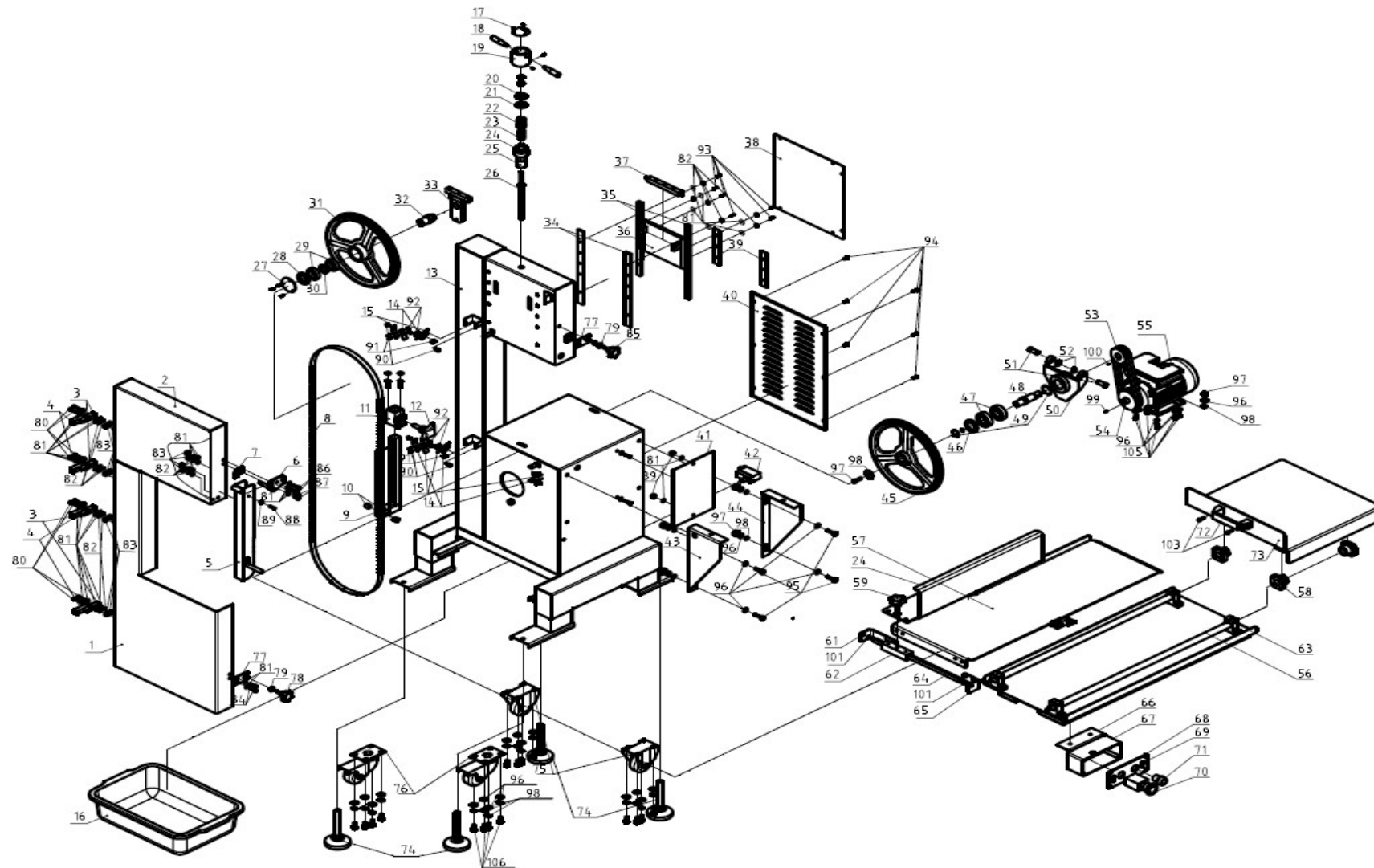

ПИЛА ДЛЯ РЕЗКИ МЯСА HURAKAN HKN-SE/3370 INOX

ПИЛА ДЛЯ РЕЗКИ МЯСА HURAKAN HKN-SE/3370 INOX

Поз	Наименование детали	Кол						
1	machine cover(down)	1	38	head cover plate	1	75	tight pulley	2
2	machine cover(up)	1	39	Slide block	2	76	mecanum wheels	2
3	hinge block	4	40	side cover	1	77	U-insert	1
4	hinge block	4	41	PCB	1	78	Door lock handle	1
5	push rod	1	42	limit switch	1	79	Handle sleeve	2
6	Push rod support frame	1	43	Fixed platen support frame-1	1	80	Hexagon socket head cap screws M6*30	16
7	Shrapnel	1	44	Fixed platen support frame-2	1	81	gasket Ø6	64
8	blade	1	45	Lower belt wheel	1	82	Spring washer	34
9	blade supporting structure	1	46	oil seal 35*50*8mm	1	83	screws M6	37
10	saw blade clamping piece	2	47	Bearing 6303	2	84	Hexagon socket head cap screws M6*20	4
11	stem casing	1	48	drive shaft	1	85	Tighten the handle M8	3
12	handle	1	49	Axle spring	2	86	Hexagon socket head cap screws M6*16	7
13	main frame	1	50	bearing block	1	87	Hexagon socket head cap screws M6*10	7
14	Scraping shrapnel	6	51	bolt	2	88	Pan head screws with cross recess M6*20	1
15	Scraper	6	52	Axle spring	2	89	screws M6	37
16	plastic case 450*310*120mm	1	53	drive shaft pulley	1	90	Hexagon socket head cap screws M6*10	7
17	Bearing cover	1	54	motor pulley	1	91	Cross countersunk nut M4*10	20
18	Regulating handle	2	55	motor	1	92	screws M4	12
19	Regulating handle 02	1	56	slider	2	93	Hexagon socket head cap screws M6*16	4
20	Relief block(up)	1	57	Fixed platen	1	94	Pan head screws with cross recess M5*10	18
21	Relief block(down)	1	58	sliding sleeve	4	95	Hexagon socket head cap screws M6*10	4
22	Compression spring	1	59	handle M8	1	96	gasket Ø8	34
23	Compression spring M10	1	60	baffle	1	97	screws M8	11
24	Block	1	61	Support chip-1	1	98	Spring washer Ø8	32
25	Block sets	1	62	Thickness regulating slide rod	1	99	Flat key 8*30	1
26	Discharge screw	1	63	slicer block	2	100	Flat key 8*20	1
27	upper pulley cover	1	64	Sliding rod fixing block	2	101	Rubber ring Ø22*3.1	2
28	oil seal 30*47*7mm	1	65	Support chip-2	1	102	Hexagon socket head cap screws M6*10	7
29	Bearing 6005	2	66	switch fixed seat	1	103	Hexagon socket head cap screws M8*25	2
30	SPACER sleeve	1	67	switch box	1	104	nylon lifting pin	4
31	upper pulley	1	68	switch box cover	1	105	Hex Bolt M8*40	6
32	up wheel shaft	1	69	switch table	1	106	Hex Bolt M8*20	16
33	Belt wheel adjustment plate	1	70	emergency stop switch	1	107	Cross head cap screw M8*10	2
34	draw runner baseplate	2	71	start switch	1			
35	draw runner	2	72	handlebar	1			
36	Adjusting sliding seat	1	73	movable table	1			
37	The shaft for adjustment	1	74	Supporting foot	4			