

ZIRCON

USER MANUAL



| | |
|--|----|
| CONTENTS | 2 |
| SYMBOL DESCRIPTION | 4 |
| Hazard intensity levels | 4 |
| GENERAL | 5 |
| Introduction | 5 |
| General instructions..... | 5 |
| Warnings..... | 5 |
| Precautions..... | 6 |
| Intended use..... | 6 |
| TECHNICAL SPECIFICATIONS..... | 7 |
| ZIRCON MINI | 7 |
| Accessories..... | 7 |
| ZIRCON 2GR | 8 |
| Accessories..... | 8 |
| ZIRCON 3GR | 9 |
| Accessories..... | 9 |
| OVERVIEW OF COMPONENTS..... | 10 |
| ZIRCON MINI | 10 |
| ZIRCON 2GR | 11 |
| ZIRCON DISPLAY CONTROL 3GR..... | 12 |
| DIMENSION SKETCH..... | 13 |
| ZIRCON MINI CONTROL | 13 |
| ZIRCON 2GR | 14 |
| ZIRCON 3GR | 15 |
| TRANSPORT | 16 |
| INSTALLATION | 16 |
| Packaging..... | 16 |
| Delivery inspection..... | 16 |
| Positioning..... | 16 |
| Electrical installation..... | 17 |
| Connection types..... | 17 |
| Water connection..... | 18 |
| Pressure and temperature | 18 |
| Starting the machine..... | 18 |
| The Portafilter set | 19 |
| Inserting the Portafilter in the group | 19 |

| | |
|--|----|
| OPERATION | 20 |
| Espresso brewing | 20 |
| Steaming and frothing milk..... | 21 |
| Hot water dispensing..... | 22 |
| ESPRESSO MACHINE WITH BUILT-IN GRINDER | 23 |
| Operations before starting up the coffee grinder | 23 |
| How to obtain a ground coffee dose | 23 |
| Adjusting the grinding coarseness..... | 24 |
| Adjusting the coffee dosing..... | 24 |
| CLEANING AND MAINTENANCE | 25 |
| Coffee machine cleaning..... | 25 |
| Daily cleaning | 25 |
| Weekly cleaning..... | 25 |
| Cleaning the Brewing group and Portafilter | 26 |
| Cleaning the gasket and shower plate..... | 27 |
| STORAGE AND DISPOSAL OF MACHINE | 28 |
| Additional handling of the machine..... | 28 |
| How to store the machine | 28 |
| Disposal of machine | 28 |
| PROGRAMMING | 29 |
| Buttons functions | 29 |
| Additional button functions | 29 |
| Programming the coffee dosage | 30 |
| PROGRAMMING USING THE DISPLAY | 31 |
| Machine status | 31 |
| Accessing the second level menu functions | 32 |
| Setting the clock: hours, minutes and day..... | 32 |
| Auto On/Off..... | 33 |
| Counters..... | 33 |
| MESSAGES AND ALARMS..... | 34 |
| TROUBLESHOOTING..... | 35 |

Hazard intensity levels

There are four different levels of notification intensity within this manual, as identified by the signal words DANGER, WARNING, IMPORTANT, and NOTE. The level of risk and importance of the notification is determined by the following definitions. Always observe the warnings to ensure safety and prevent potential injury and product damage.



Important:

Alerts against unsafe practices. Observe *Important* notifications to ensure food safety, prevent possible minor personal injury, or damage to the machine.



WARNING:

Indicates a potentially hazardous situation which, if the **WARNING** is ignored, could result in serious injury or even death.



DANGER:

INDICATES A IMMINENTLY HAZARDOUS SITUATION WHICH, IF NOT AVOIDED, WILL LIKELY RESULT IN SERIOUS INJURY AND EVEN DEATH.



Note:

Gives additional information which may be helpful during the operation, routine maintenance, and cleaning of the machine.

Introduction

Thank you for choosing a Zircon espresso machine.

We hope you enjoy it !

- Read this user manual carefully before starting to use the machine.
- This manual contains important instructions regarding safe intended use of the machine.
- Do not discard this manual, it will be useful for future reference. If damaged or lost, request a copy from the manufacturer.

General instructions

- Machine installation and certain maintenance operations should only be performed by qualified service personnel.
- All safety instructions and warnings contained in this manual should be observed at all times to ensure safe installation, use, and maintenance.
- Do not attempt to remove covers or safety shields to access the interior of this machine or make repairs. Repairs should be made by an authorised technician or service centre.
- Owners are liable for ensuring that users have been properly trained to operate the machine and understand the potential risks involved.
- The owner or installer will be liable for all non-authorised modification of the machine.
- Non-authorised alteration or modification of the machine will immediately void the manufacturer's warranty.
- This manual references the machine at the time of sale. The commercial availability of subsequent versions including modifications, upgrades or adaptations does not oblige the manufacturer to apply any changes to this machine, nor is it obliged to update the documentation supplied.
- The manufacturer reserves the right to withdraw currently available manuals whenever deemed appropriate and reasonable.
- Periodically, some updates and changes may be required for this machine. In this event, a technician will be responsible for ensuring the change is made in accord with manufacturer's specifications.

Warnings

Note: The manufacturer is not liable for damage to persons or property resulting from failure to follow the instructions and warnings listed below when installing and using this machine.

- Install the machine in a horizontal position and away from heat sources and flammable objects.
- This machine should only be installed on a water-resistant work surface that is capable of adequately supporting the machine's weight.
- Place the machine in a location accessible only to personnel trained to operate it.
- Keep all hazardous packaging materials, such as plastic bags, styrofoam, and staples, out of reach of children.
- Plug the machine into a properly installed, earth grounded electrical outlet with line voltage that matches the specifications for the machine.
- Ensure that the power supply voltage does not fluctuate by more than 6%.
- Position the power cable so that users cannot trip over it. Keep the power cable away from sharp edges and heat sources.
- Children should never be allowed to play with the machine.
- This appliance is not suitable for installation in an area where a pressure washer may be used.
- Do not use the machine outdoors, where it would be exposed to severe weather or extreme temperatures.
- If the power cable is damaged, it may only be replaced by the manufacturer or its approved service technician.
- Do not remove or disable any of the mechanical, electrical, or thermal protection safety equipment.

- In case of emergency, (e.g., the machine catches fire or becomes unusually hot or noisy), disconnect the power immediately and turn off the water supply.
- If the machine is not going to be used for an extended period of time, disconnect the power. When disconnecting the power, pull the plug rather than the cable.
- When packed for storage, store the machine in a dry place with an ambient temperature above 5°C. Boxes may be stacked up to three units high of the same model. Do not place other heavy items on top of the box.
- If the machine is likely to be exposed to temperatures below 0 °C during handling and transport, make sure that service personnel empty the boiler and water system. (The machine's boiler and water system is empty when delivered from the factory.)
- To ensure fault-free machine operation, only use manufacturer-approved replacement parts and accessories.

Precautions

- Before performing maintenance and/or moving the machine, disconnect the machine from the power supply and wait for it to cool down.
- Do not place any liquids on the machine.
- This appliance must not be cleaned with a pressure washer.
- Never immerse the machine, plug or power cable in water, as there is a risk of electric shock.
- Do not touch the machine's hot surfaces or dispensing equipment.
- Do not touch the machine if your hands or feet are wet.
- Do not operate the machine if any part except the dispensing equipment is wet.
- Place the machine out of reach of children.
- This appliance can be used by children from age 8 and above and persons with reduced physical, sensory, or mental capabilities or lack of experience and knowledge if they have been given supervision or instruction concerning use of the appliance in a safe way and understand the hazards involved.
- Children shall not play with the appliance.
- Cleaning and user maintenance shall not be made by children without supervision.
- Do not use the machine if the power cable or plug is damaged, or the machine has been dropped. Contact a service technician for repairs or to ensure that it is safe for use.
- Do not block the vents with rags or other objects.
- Do not insert foreign objects into the vents.
- Check the drain regularly to make sure that waste water is emptying properly.

Intended use

- The coffee machine has been designed and manufactured to make espresso coffee and other hot drinks (e.g., steaming and frothing milk). Do not use it for any other purpose.
- The machine is intended to be used by trained personnel for preparing foodstuffs.
- This machine is not intended for use in industrial kitchens, domestic kitchens, or similar locations.
- The manufacturer will not be held liable for damage to persons or property due to incorrect, improper or negligent use by nonprofessional personnel.
- To ensure optimal performance, install the machine in a location where these parameters will not be exceeded:
 - Maximum permissible inlet water pressure: 600 KPa (6 Bar)
 - Minimum permissible inlet water pressure: 200 KPa (2 Bar)
 - Maximum inlet water temperature: 40°C
 - Ambient temperature is between +10 °C (min.) and +40 °C (max.).

ZIRCON MINI

| SPECIFICATIONS | MODEL | | |
|---------------------------------|-----------------------------|--------------------------------------|-----------------------------|
| | MINI CONTROL IGR | MINI GRINDER | MINI 2GR |
| Steam wand | 1 unit | | |
| Hot water outlet | 1 unit | | |
| Temperature control | Pressure switch | | |
| Programmed via display | No | | |
| Dispensing system for tall cups | Optional | | |
| Energy saving mode | No | | |
| Height, width, depth (mm) | 530, 460, 590 | 630, 460, 590 (incl. bean hopper) | 530, 460, 590 |
| Boiler volume (l) | 6 | | |
| Power supply | 230V 1N~ 2770 W 50/60 Hz | 230V 1N~ 3125W 50/60 Hz | 230V 1N~ 2780 W 50/60 Hz |
| Water connection | Female 3/8" thread | | |
| Machine weight (kg) | 35.45 | 47.00 | 40.45 |
| Steam boiler operating pressure | Between 0.8 and 1.2 bar | | |
| Ambient noise | < 70 db | | |

Accessories

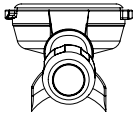
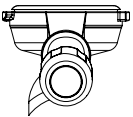
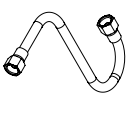
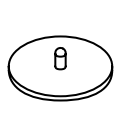
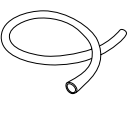
| MODEL | 2-spout portafilter | 1-spout portafilter | 55cm inlet hose | Cleaning membrane | Drainage tube (150cm) |
|-----------------|---|---|---|---|---|
| |  |  |  |  |  |
| MINI IGR | 1 unit | 1 unit | 1 unit | 1 unit | 1 unit |
| MINI 2GR | 1 unit | 1 unit | 1 unit | 1 unit | 1 unit |

ZIRCON 2GR

| SPECIFICATIONS | MODEL | | |
|--|--------------------------|------------|--------------------------|
| | 2GR CONTROL | 2GR PULSER | 2GR DISPLAY |
| Steam wand | 1 unit | | 2 units |
| Hot water outlet | 1 unit | | 1 unit |
| Temperature control | Pressure switch | | PID regulation |
| Programmed via display | Yes | | |
| Dispensing system for tall cups | Optional | | |
| Energy saving mode | No | | Yes |
| Height, width, depth (mm) | 530, 680, 590 | | |
| Boiler volume (l) | 11.5(L) | | |
| Power supply | 230V 1N~ 3330 W 50/60 Hz | | |
| | 400V 3N~ 4780 W 50/60 Hz | - | 400V 3N~ 4780 W 50/60 Hz |
| Water connection | Female 3/8" thread | | |
| Machine weight (kg) | 45.20 | 55.00 | 60.90 |
| Steam boiler operating pressure | Between 0.8 and 1.2 bar | | |
| Ambient noise | < 70 db | | |

Accessories

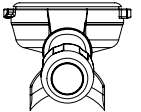
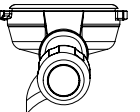
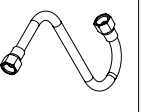
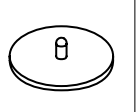
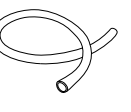
| MODEL | 2-spout portafilter | 1-spout portafilter | 55cm inlet hose | Cleaning membrane | Drainage tube (150cm) |
|------------|---|---|---|---|---|
| |  |  |  |  |  |
| 2GR | 2 units | 1 unit | 1 unit | 1 unit | 1 unit |

ZIRCON 3GR

| SPECIFICATIONS | MODEL | |
|--|--------------------------|----------------|
| | 3GR CONTROL | 3GR DISPLAY |
| Steam wand | 2 units | |
| Hot water outlet | 1 unit | |
| Temperature control | Pressure switch | PID regulation |
| Programmed via display | No | Yes |
| Dispensing system for tall cups | Optional | |
| Energy saving mode | No | Yes |
| Height, width, depth (mm) | 530, 980, 590 | |
| Boiler volume (l) | 17.5 | |
| Power supply | 400V 2N~ 4290 W 50/60 Hz | |
| | 400V 3N~ 6290 W 50/60 Hz | |
| | 230V 3N~ 6290 W 50/60 Hz | |
| Water connection | Female 3/8" thread | |
| Machine weight (kg) | 64.55 | |
| Steam boiler operating pressure | Between 0.8 and 1.2 bar | |
| Ambient noise | < 70 db | |

Accessories

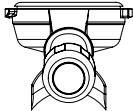
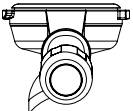
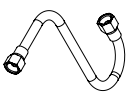
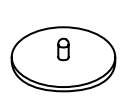
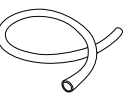
| MODEL | 2-spout portafilter | 1-spout portafilter | 55cm inlet hose | Cleaning membrane | Drainage tube (150cm) |
|------------|---|---|---|---|---|
| |  |  |  |  |  |
| 3GR | 3 units | 1 unit | 1 unit | 1 unit | 1 unit |

Front view of the machine

ZIRCON MINI

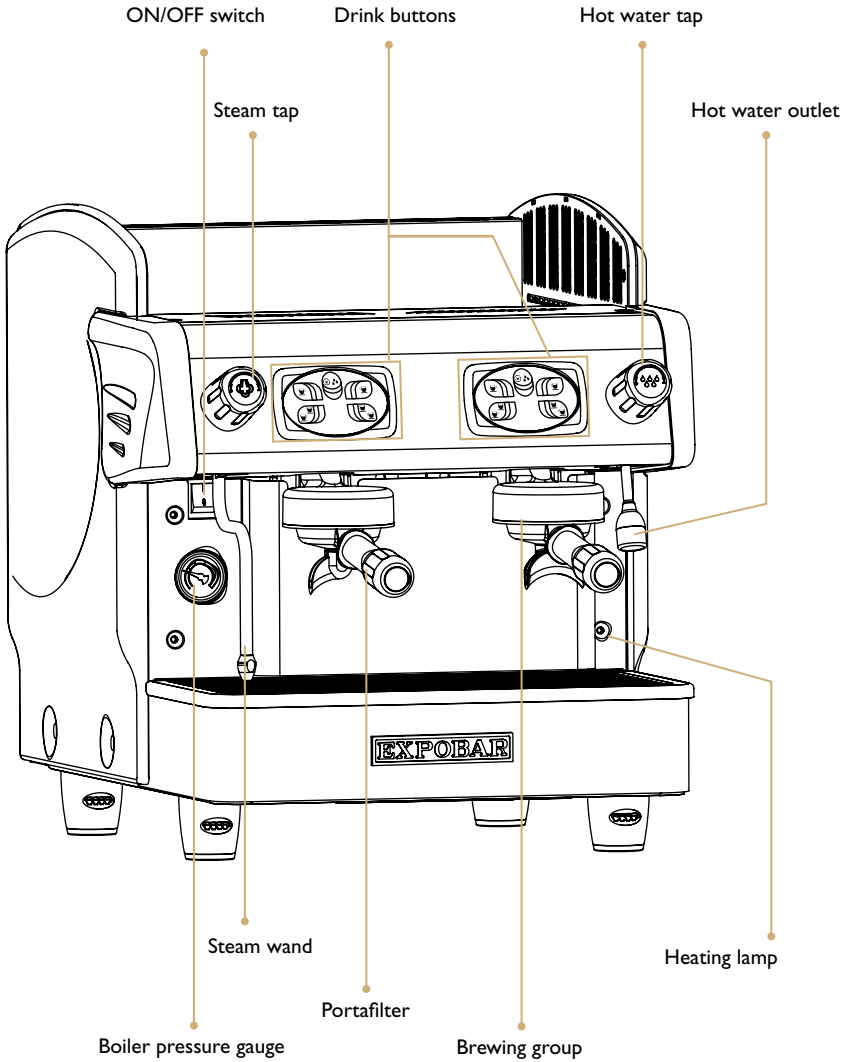

Front view of the machine

ZIRCON 2GR

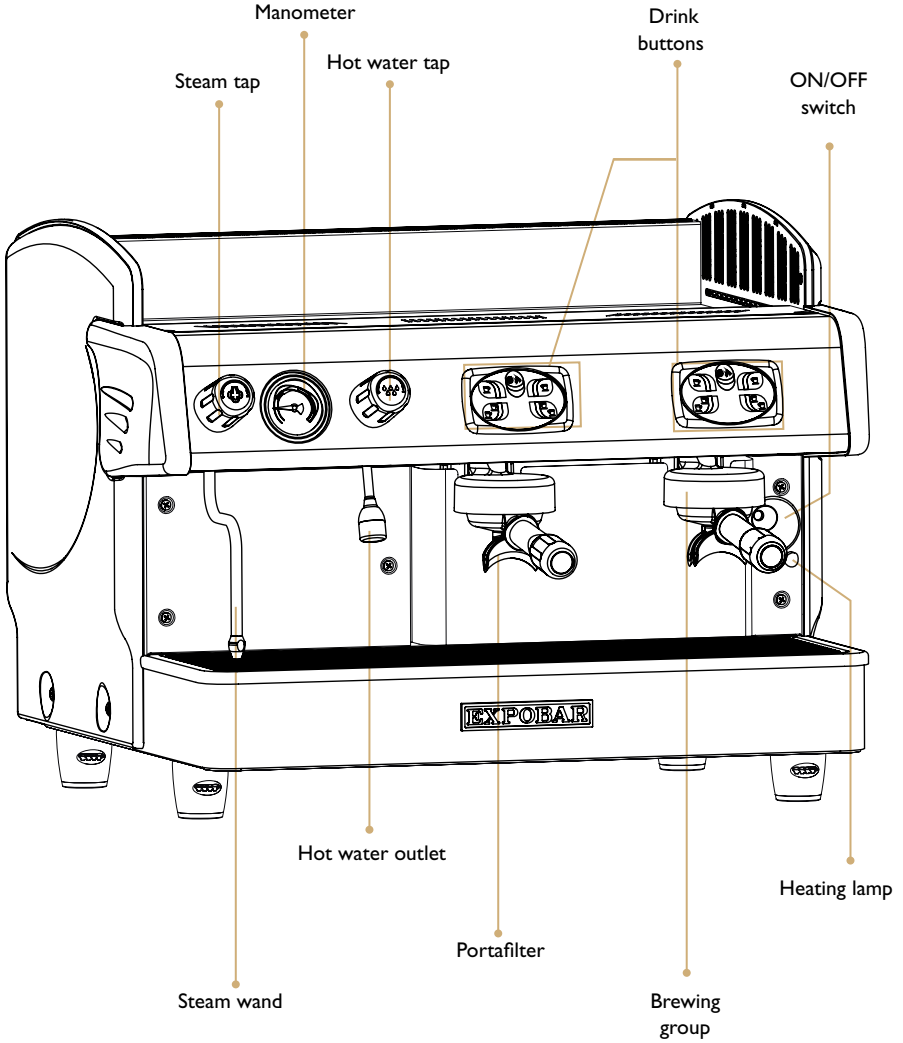

Front view of the machine

ZIRCON DISPLAY CONTROL 3GR

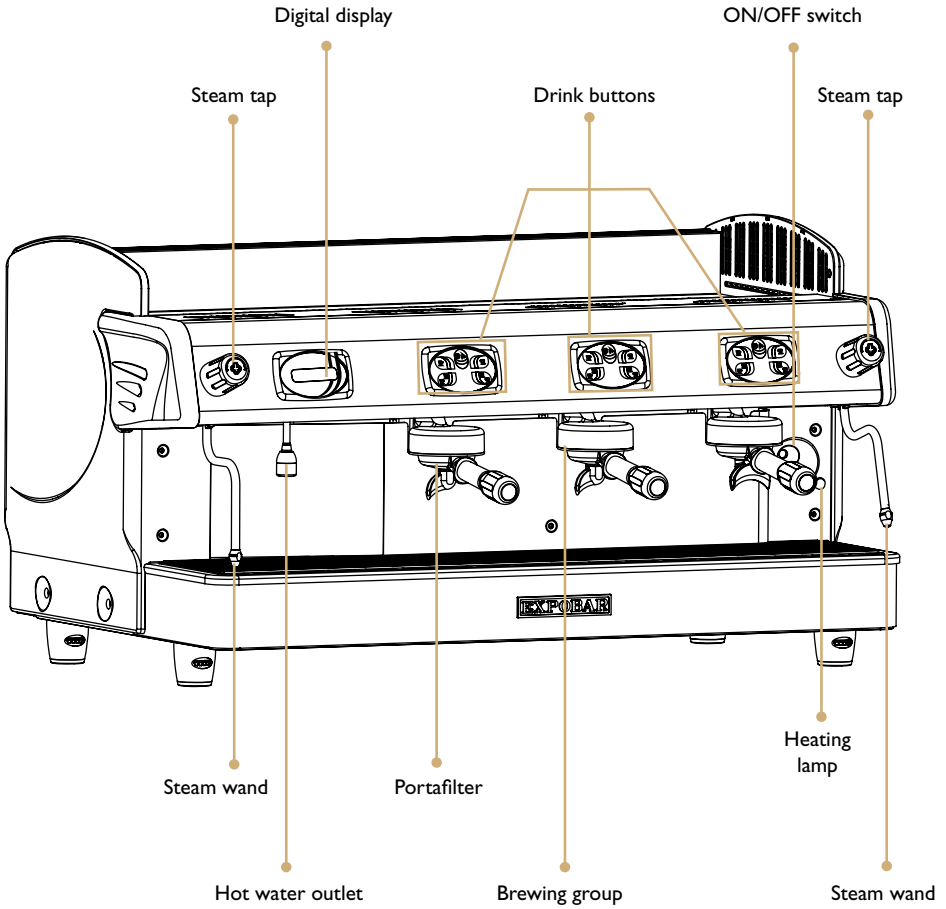

ZIRCON MINI CONTROL

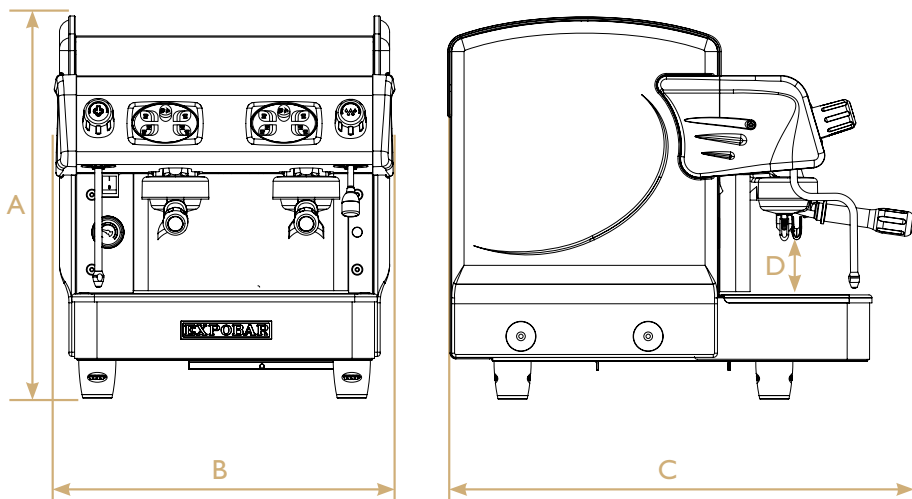

| Model | A | B | C | D |
|----------------------------------|--------|--------|--------|--------|
| ZIRCON MINI 1Gr | 530 mm | 460 mm | 590 mm | 74 mm |
| ZIRCON MINI 1Gr Take Away | 530 mm | 460 mm | 590 mm | 124 mm |
| ZIRCON MINI 2Gr | 530 mm | 460 mm | 590 mm | 74 mm |
| ZIRCON MINI 2Gr Take Away | 530 mm | 460 mm | 590 mm | 124 mm |

ZIRCON 2GR

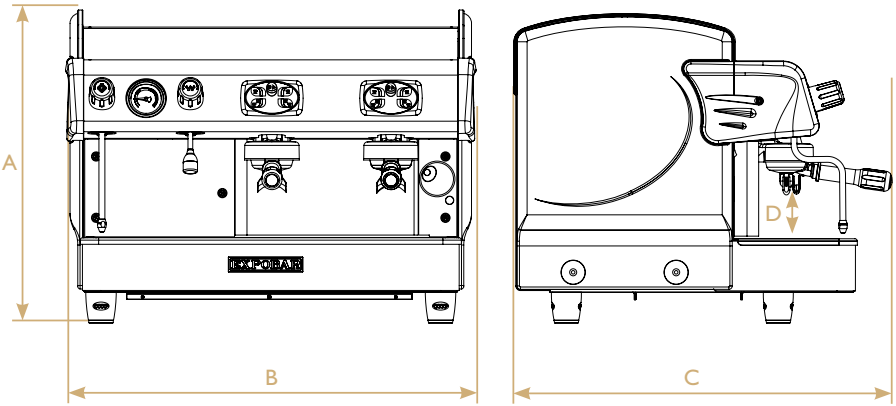

| Model | A | B | C | D |
|---------------------------------------|--------|--------|--------|--------|
| ZIRCON 2Gr | 530 mm | 680 mm | 590 mm | 74 mm |
| ZIRCON 2Gr Take Away | 530 mm | 680 mm | 590 mm | 124 mm |
| ZIRCON 2Gr 3 Boilers | 530 mm | 680 mm | 590 mm | 74 mm |
| ZIRCON 2Gr 3 Boilers Take Away | 530 mm | 680 mm | 590 mm | 124 mm |

ZIRCON 3GR

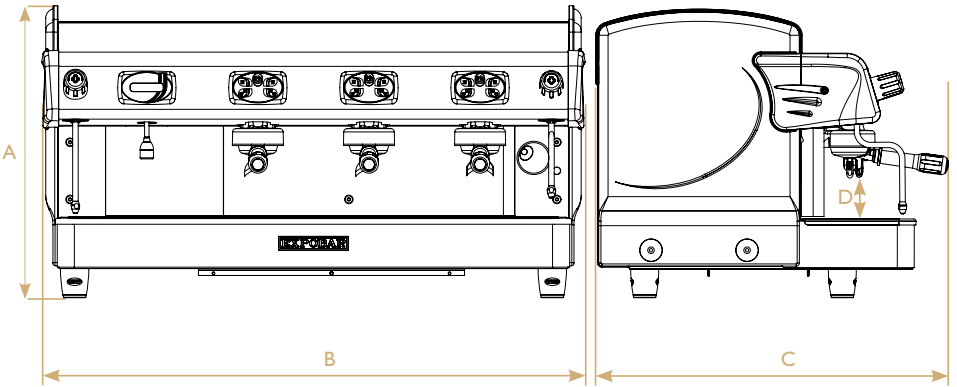

| Model | A | B | C | D |
|---------------------------------------|--------|--------|--------|--------|
| ZIRCON 3GR | 530 mm | 980 mm | 590 mm | 74 mm |
| ZIRCON 3GR Take Away | 530 mm | 980 mm | 590 mm | 124 mm |
| ZIRCON 3Gr Boilers | 530 mm | 980 mm | 590 mm | 74 mm |
| ZIRCON 3Gr 4 Boilers Take Away | 530 mm | 980 mm | 590 mm | 124 mm |

Packaging

- The machine is shipped in a custom-designed carton which utilizes model-specific polystyrene cushions to protect it from damage.
- The machine's carton features standardized handling symbols to explain proper shipping and storage methods.
- The machine must remain in a horizontal position during the transport. Do not store or handle the machine except on its feet.
- During transport protect the carton and machine from impact drops, crushing, shocks, moisture and exposure to extreme temperature.

Delivery inspection

- Upon receipt and delivery ensure that the machine is in the exact condition described in the enclosed documentation, and that all accessories are included. Missing items should be reported to the manufacturer or dealer immediately.
- Damage caused during transport should be reported to the shipping agent and the machine's distributor immediately.
- Packaging materials are potentially dangerous and should be kept away from children.
- The carton and all packing materials are recyclable and should be returned to a recycling center for disposal.

INSTALLATION

Positioning

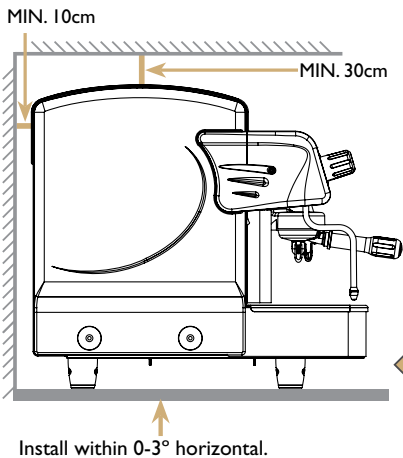

- Install the machine on a level, sturdy, and water-resistant surface approximately 110cm above floor level for ease of access and usage.
- Adjust the feet to ensure that it dispenses coffee evenly to all cups.
- Ensure enough free space is available above (>30cm) and behind (>10cm) the machine to ensure easy cleaning and maintenance and adequate ventilation.
- Do not install the machine if it is wet or damp. Allow it to dry completely and ask a service technician to ensure that none of the electrical components have been affected.



Note:

Leave an air gap of at least 30cm above the machine and 10cm behind it to ensure adequate ventilation. The machine must be installed within 3° of horizontally level front-to-back and side-to-side to ensure proper hydraulic function and drainage. Confirm with a spirit level or digital angle gauge.

Electrical installation

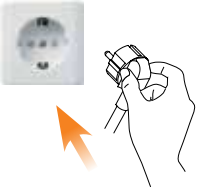

The machine should only be connected to the power supply by qualified personnel. The following safety instructions should be obeyed at all times:

- Ensure that the electrical requirements stated on the **TECHNICAL SPECIFICATIONS** (pages 7 - 9) match the specifications of the power supply at the outlet.
- Ensure that the domestic electrical supply where the machine is being installed is rated for and able to provide the power required by the machine. Insufficient power supply, wiring, grounding, or insulation can result in overheating and possibility of fire.
- The coffee machine must be connected to an earth grounded electrical outlet that complies with the regulations in force in the country of installation.
- Ensure that a circuit breaker engineered for the power consumption of the machine is installed to protect the domestic electrical supply, as specified on the ratings plate located under the drip tray.
- Do not connect the machine to the domestic power supply via extension cords, plug adapters, or shared outlets.

The manufacturer will not be held liable for damage to persons, animals or property resulting from incorrect installation of the coffee machine.



DANGER!

If the power cable or plug is damaged, it must be replaced by the manufacturer, distributor, or its approved service technician in order to avoid **RISK OF SERIOUS INJURY OR DEATH!**

Connection types

- Connect the machine according to the specification on the ratings plate located under the drip tray.

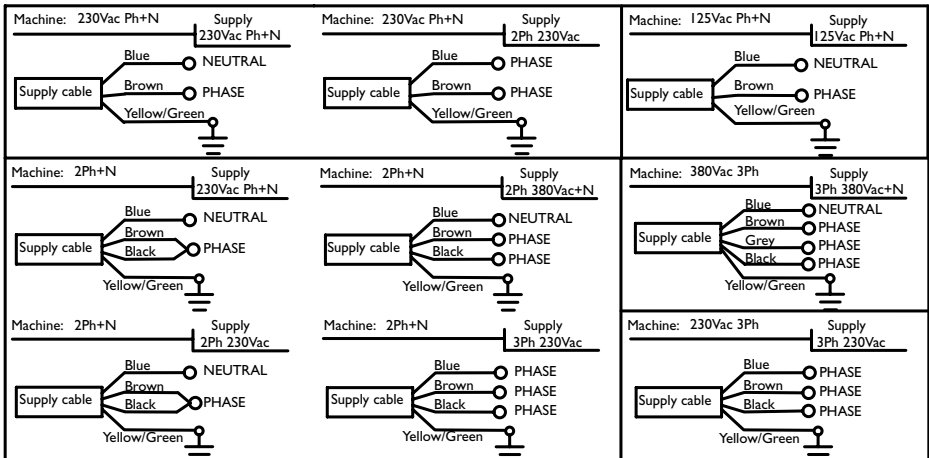

Water connection

- Connecting the machine to the domestic water supply must be performed by a qualified person.
- Purge at least 20 liters of water from the domestic water supply before connecting the machine to it to flush out any debris that may be in the plumbing system that would otherwise accumulate inside the boilers.
- The domestic plumbing system should be fitted with a brass 3/8" NPT male pipe fitting and an in-line shut-off valve. Connect the 180cm water inlet hose included with the machine to the domestic water supply and tighten the line fittings with a wrench to 15 ft. lbs. / 20N-m.
- Only use safe drinking water with a hardness rating between 5°fH and 8°fH (French hardness degrees) or 20 to 32 ppm (parts per million as calcium). If the hardness value is below this limit, corrosion of hydraulic components is likely. If the value is higher, lime-scaling inside the boiler will occur. In both cases, the proper function of the machine and quality and taste of the coffee will be negatively affected.
- If necessary, connect the machine to a water softener to reduce water hardness using the flexible 55cm hose included in the accessory box.
- Connect one end of the corrugated drain tube to the drain cup in the machine, connect the other end to the plumbing drainage system in the installation area.



Important:

- Only use the hoses supplied with the machine. Never reuse damaged hoses.
- Ensure that the drainage tube is not twisted and that it is below the level of the drain cup.

Pressure and temperature

- Boiler pressure is directly controlled by water temperature (fig. 01).
- This machine is fitted with a pressure gauge that displays the boiler pressure, if the machine is equipped with a digital display it will also indicate water temperature.

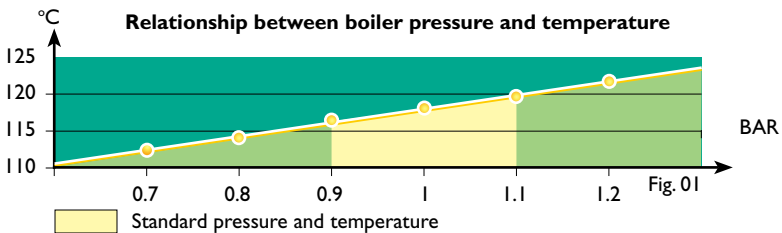

Starting the machine

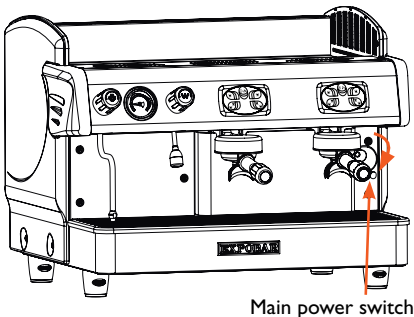

- Open the machine's water supply valve.
- Turn on the main power switch.
- Press a drink button at the control panel on each group, wait until water comes out continuously from each of them. This ensures that the heat exchangers in the machine are being correctly filled.
- Open the steam lever to release the air trapped in the boiler.
- The red lamp indicates that the boiler is heating. The lamp switches off automatically when the machine reaches operating temperature.
- The machine is now ready to use.

The Portafilter set

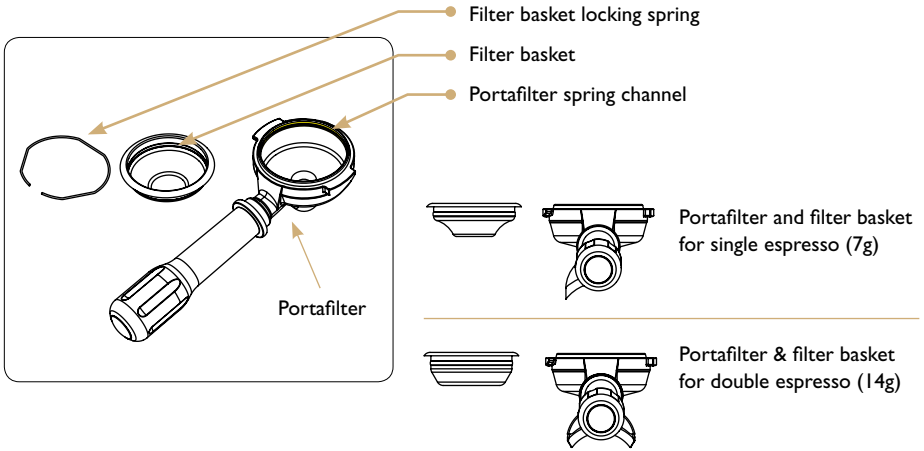

Inserting the Portafilter in the group

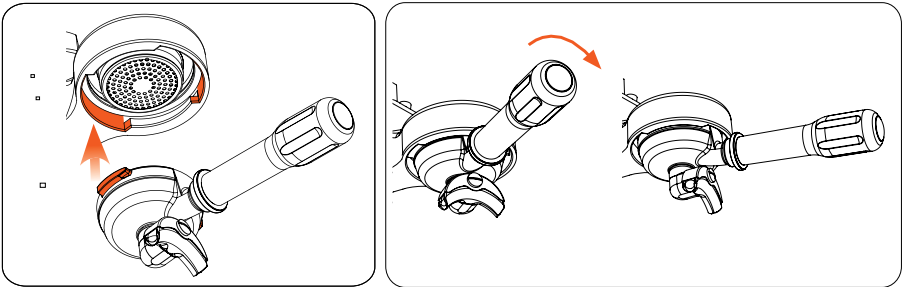

- Align the portafilter's two flanges with the two slots in the group housing.
- Insert the portafilter and rotate it counterclockwise until the handle is approximately perpendicular to the face of the coffee machine.

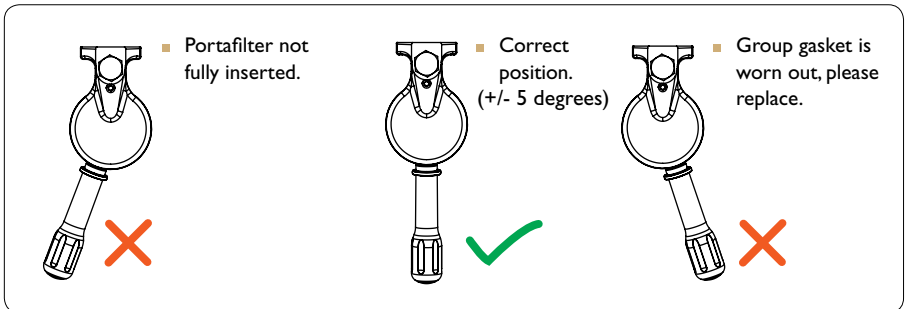

Espresso brewing



Important:

Always keep the portafilter inserted in the group to keep it warm. This is important to maintain an optimal temperature when the espresso is dispensing.

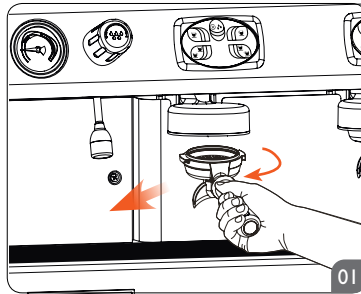

▲ Unlock and remove the portafilter from the group head.

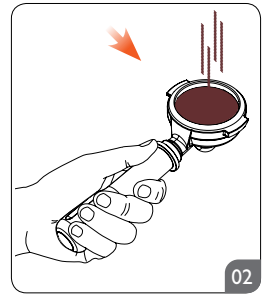

▲ Fill the filter basket with espresso-grind coffee (amount will differ depending on filter basket size). For best results use only freshly ground espresso beans.

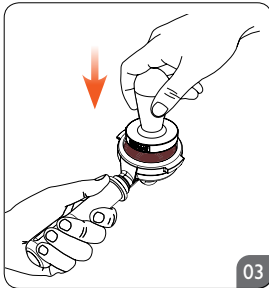

▲ Press the coffee with the coffee tamper.

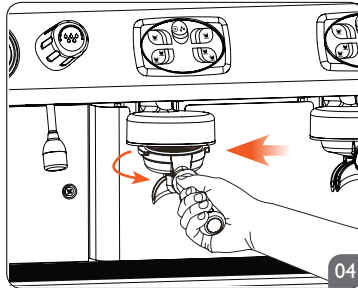

▲ Insert the filled portafilter into the group head and lock it into the correct position.

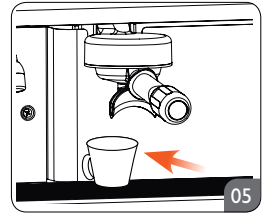

▲ Place the cup(s) under the portafilter outlet(s).

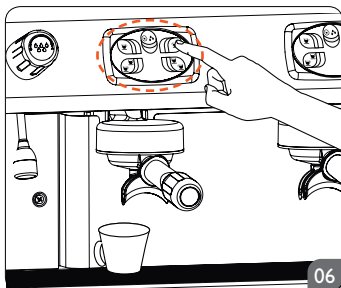

▲ Select the desired option from the drink buttons.



WARNING!

Never try to open the portafilter while the machine is in operation! The pressurised hot water could cause scalding or serious injury. After dispensing has finished, wait at least 3 seconds before removing the portafilter.

Steaming and frothing milk

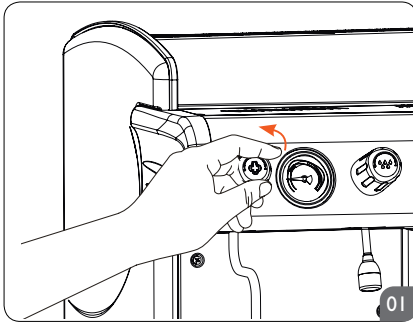

- ▲ Place the steam wand over the drip tray and open the steam lever for a few seconds to allow condensed water to be ejected. Close the steam lever when only steam comes out.

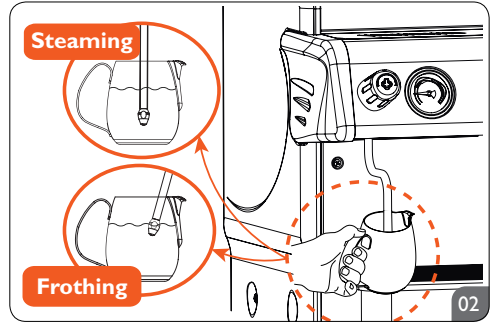

- ▲ Immerse the steam wand into the milk, making sure the wand tip is submerged.

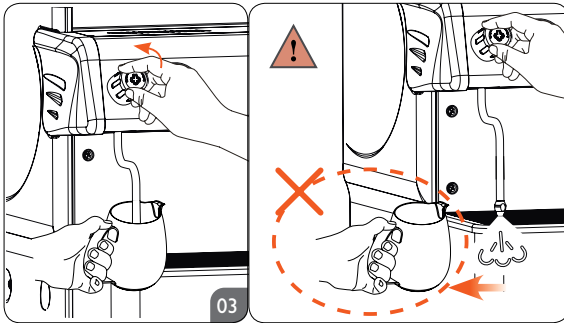

- ▲ Open the steam lever again to begin steaming or frothing the milk. Do not remove the milk pitcher while steaming.

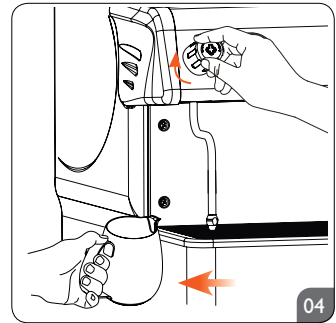

- ▲ Once the milk reaches the desired temperature, close the lever and remove the pitcher.

**WARNING!**

Do not allow the steam wand to extend out of the milk when the lever is open, it may cause serious burns and injuries.

- ▶ After the process is finished, position the steam wand over the drip tray and open the steam lever for a few seconds to eject any milk remaining in the wand. Close the lever and then wipe down the outside of the steam wand with a damp cloth to prevent nozzle blockage and to keep it clean. Leaving milk in or on the wand will affect the taste of later drinks.

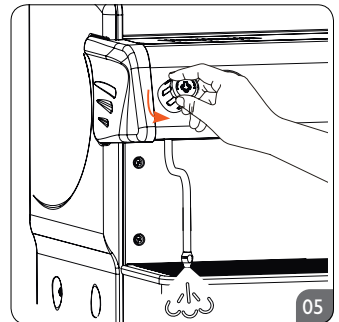

Hot water dispensing

Machines with manual water tap

- Place a jug (or similar) under the hot water outlet
- Open the hot water tap.
- Close the tap as soon as the machine has dispensed the desired amount of water.

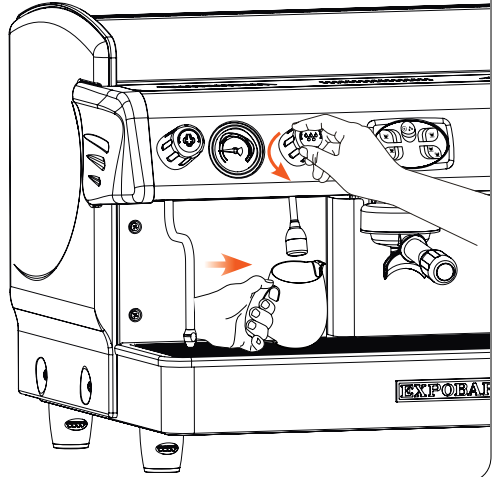
**WARNING!**

Never expose hands and fingers directly under the water outlet during operation to avoid scalding or serious burns.

Machines with automatic water tap

- Place a pitcher (or other heat resistant vessel) under the hot water outlet.
- Press the hot water button (A) for 3 seconds to begin dispensing.
- Wait until the machine stops dispensing hot water automatically, or press the button again to stop hot water dispensing at any time.

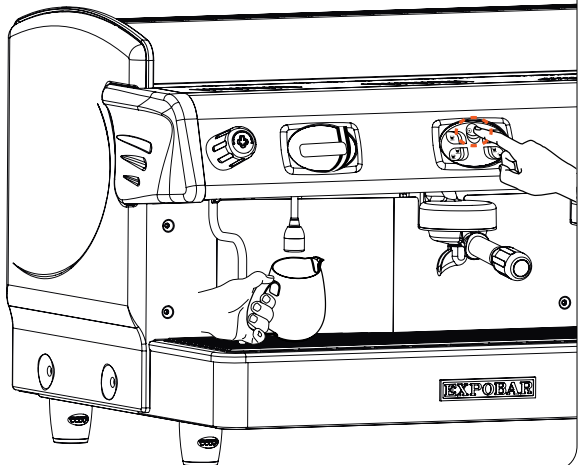

Operations before starting up the coffee grinder

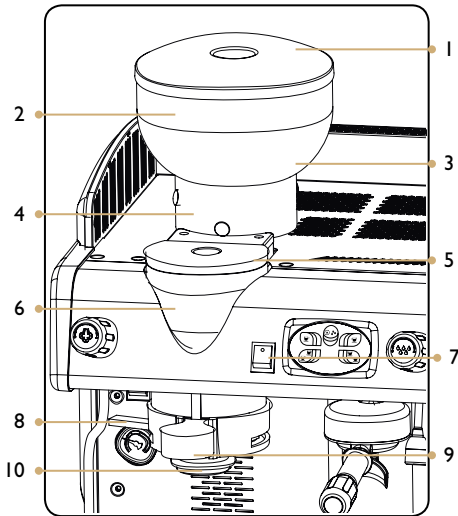

| Pos. | PART NAME |
|------|--------------------------|
| 1 | Bean hopper lid |
| 2 | Bean hopper |
| 3 | Bean stop |
| 4 | Grinding adjustment disk |
| 5 | Dosage device lid |
| 6 | Dosage device |
| 7 | Grinder on/off switch |
| 8 | Dosage lever |
| 9 | Coffee tamper |
| 10 | Ground coffee outlet |

- Check that the bean hopper (2) is correctly fitted in place.
- Lift up the bean hopper lid (1), fill the bean hopper (2) with coffee beans and close it again.
- Open the bean stop (3) to allow the coffee beans to flow into the grinder.

How to obtain a ground coffee dose

- Place a portafilter under the ground coffee outlet (10)
- Pull the lever (8) towards you repeatedly until the desired amount of coffee is dispensed.
- Place the portafilter under the coffee tamper (9) and push it upwards in to level off and compact the coffee.

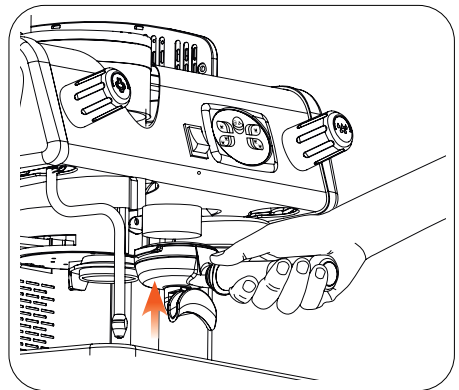
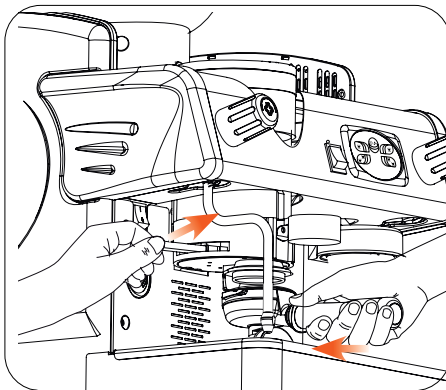

Adjusting the grinding coarseness

- For a finer ground coffee:
Turn the grinding adjustment disc(4) clockwise.
- For a courser ground coffee:
Turn the grinding adjustment disc(4) counter-clockwise.



Important:

You should only adjust the coarseness when the grinder is turned off.

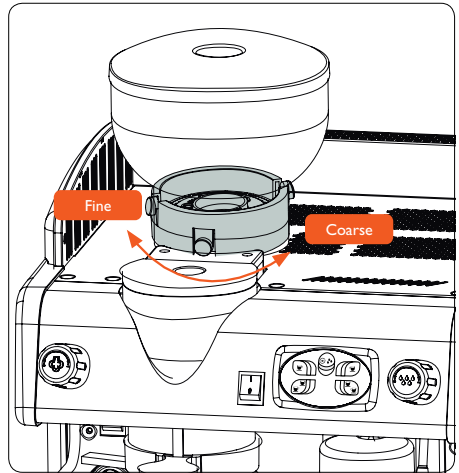

Adjusting the coffee dosing

- Switch OFF the grinder main power switch (7).
- Remove the dosage device lid (5).
- For a lower dosage:
Turn the dose quantity adjustment nut (A) clockwise.
- For a higher dosage:
Turn the dose quantity adjustment nut (A) counter-clockwise.
- Replace the dosage device lid (5).
- Switch ON the grinder main power switch (7) before the next use.

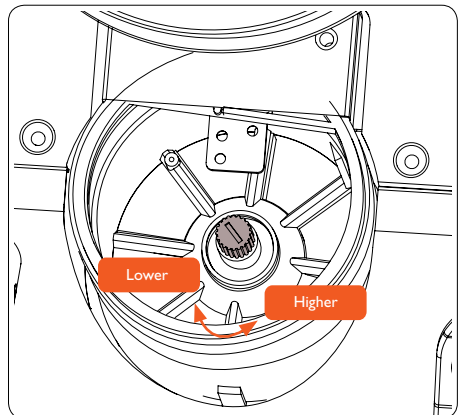

Coffee machine cleaning

**Important:**

- To keep the machine looking and working like new, you should always follow the cleaning and care instructions provided in this manual.
- Always turn off the main power switch when cleaning the exterior of the machine.
- All external surfaces should be cleaned with a damp, lint-free cloth that will not scratch the machine.
- Do not use aggressive cleaning detergents, solvents or degreasers. These can damage the surfaces, and plastic and rubber parts, and leave unwanted residue.

**Important:**

Each day, or 8 hours after dispensing the last coffee, the following cleaning tasks should be performed to maintain the quality and performance of the water system:

- **Portafilter:** Brew one espresso with the filter empty (around one minute) to flush it out (dispose of this water).
- **Steam Wand:** Position the wand over the drip tray and open the steam lever for one minute to flush the wand.
- **Hot Water Outlet:** Place a container under the water outlet and open the lever for 20 seconds (dispose of this water).

Daily cleaning

- Rinse each of the brewing groups, shower plates, and portafilters with hot water for 15 seconds.
- Clean the external surfaces of the machine with a damp cloth, paying special attention to the stainless steel parts.
- Clean the steam wand and the water tap. Be sure that the nozzles are not clogged or partially blocked with milk or other residue. If it's necessary to remove them for cleaning, be careful not to deform or damage any of the components during removal.
- Clean the drip tray and the stainless steel insert grid under running water with a brush.
- Clean the drain cup by slowly pouring one liter of warm water into it to dissolve and remove the coffee residue that accumulates inside the drain cup and hose.

Weekly cleaning



- Clean the brewing group and portafilter with professional cleaning powder (page 26).

Cleaning the Brewing group and Portafilter



WARNING!

Never try to remove the portafilter while the group is performing the cleaning operation, as the pressurized hot water could cause scalding or serious injury. After cleaning has finished, wait at least 3 seconds before removing the portafilter.

- Unlock and remove the portafilter from the group head.
- Place the cleaning membrane in the filter basket.
- Fill the filter basket with professional cleaning detergent (7gr. for a single espresso portafilter, 14gr. for double espresso portafilter). Detergent is available from your distributor as Part # 1104162.
- Lock the portafilter into the group head.
- To activate the cleaning and descaling program:
 - 1.) Turn off the machine at the main switch.
 - 2.) Press and hold down the 2 Short Espressos button  on the control panel of the group requiring cleaning. Without releasing the button, turn on the machine. Auto-cleaning will start automatically.
 - 3.) Release the button. The machine will clean, flush, and rinse itself.
 - 4.) If any residual powder is present, simply rinse the portafilter under clean water and press the Continuous Dispensing  button and allow it to flow for 15 seconds with no portafilter in place. **OR**, simply repeat steps 1 through 3 with using any detergent to rinse the group and portafilter.
 - 5.) When all cleaning/descaling is complete, remove the blind gasket and store it in a secure place.



Important:

Boiler descaling is only to be performed by a qualified technician, and frequency will depend on local water conditions and frequency of machine use. Contact your distributor for boiler descaling questions and technical assistance.



Note:

- Clean the group and portafilter with detergent once a week.
- For daily cleaning, rinse the group and portafilter without detergent (only using the membrane and hot water) by making .

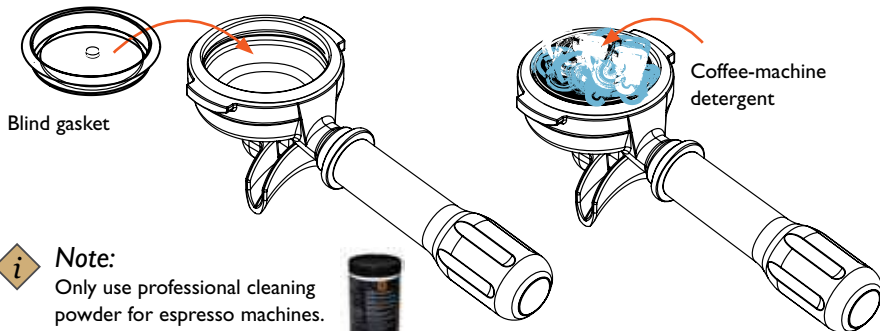

Note:

Only use professional cleaning powder for espresso machines. It's available from your distributor.



Part #: 1104162

Cleaning the gasket and shower plate

Cleaning the gasket

While making espresso, coffee grounds will naturally accumulate on the group's sealing surface. Allowing an excessive amount of grounds to build up can prevent the portafilter from properly sealing to the group head. In extreme cases, such as leaving a used portafilter in the group head for several days, water can even become blocked from passing through the shower plate.

To prevent these problems, perform the following cleaning procedures daily:

- Install the blind basket into the portafilter without cleaning powder.
- Place the portafilter loosely in the group head - do not close it fully.
- Press the Continuous button .
- Perform an opening-closing motion with the portafilter in place without closing it fully. Water will flow over and around the portafilter, passing through the closing surface and washing out any coffee residue. Be very careful to avoid splashes, as this water is very hot and can cause burns.
- Press the Continuous button  again to stop the water flow.

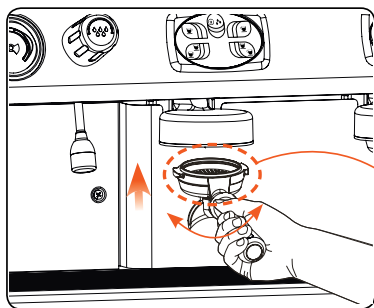

WARNING!

Take special care to avoid scalding when performing this cleaning operation, as the hot water used to clean the gasket will spill over the sides of the portafilter.



WARNING!

Do not fully tighten the portafilter. If fully tightened, high-pressure water may spray out and cause scalding or serious injury.

Cleaning the shower plate

- Remove the portafilter from the group head.
- Clean the shower plate and group gasket with a soft brush to remove any coffee residue.

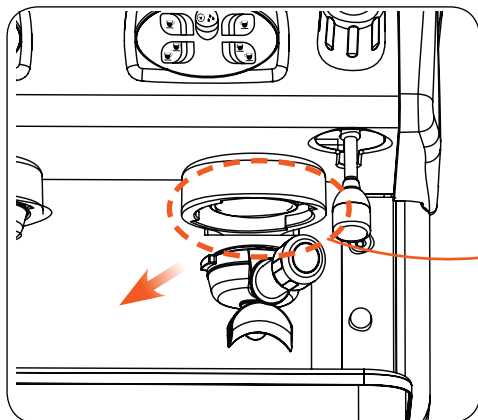

Remove coffee residue with a food-safe brush

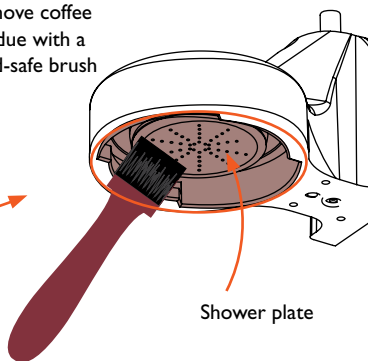

Shower plate

Additional handling of the machine

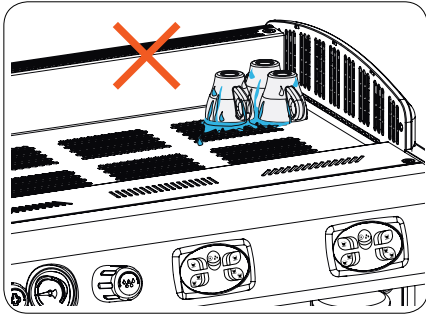

Important:

Do not place wet cups directly on the cup shelf. Allowing water to drip into the machine can cause mechanical and electrical damage.

- Always remove and insert the portafilters gently. Never use excessive force to try to close the portafilter. If the portafilter does not turn and lock into place without excessive force this usually indicates that there is too much coffee in the filter basket.

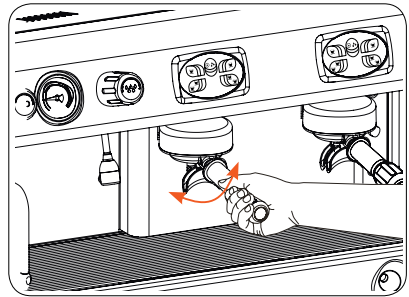

STORAGE AND DISPOSAL OF MACHINE

How to store the machine

Before storage be sure to:

- Perform all weekly and periodic cleaning procedures described in this manual (see pages 16-20).
- Disconnect and roll up the power cord (this should be performed by a qualified person).
- Disconnect the machine's water inlet hose from the domestic water supply and drain the boilers (this should be performed by a qualified person).
- Clean the drip tray and exterior of the machine to remove any coffee or other residue.
- Cover / re-pack the machine in its original carton and store it in a dry place where it will not be exposed to extreme temperatures or humidity.
- When returning the machine to service after long-term storage, perform all weekly and periodic cleaning procedures before use.

Disposal of machine

- Disconnect and roll up the power cord (this should be performed by a qualified person).
- Disconnect the machine's water inlet hose from the domestic water supply and drain the boilers (this should be performed by a qualified person).
- Pack up and ship/deliver the machine to a certified recycling center.



Buttons functions

The following functions can be programmed and controlled from the digital display:

- Volume control of four different espresso drinks per brewing group.
- Timed hot water dispensing.
- Automatic boiler filling and level control.
- Automatic heating element shut-down in event of a low water condition.
- System supervision through messages, warning, and alarms.
- Automatic cleaning of the brewing groups.

The digital controller is programmed with four standard drink functions (these can be reprogrammed as desired by the user) and one continuous function from the manufacturer.

The left four buttons (1 Short Espresso, 1 Long Espresso, 2 Short Espresso, 2 Long Espresso) will brew the programmed beverage volume and then stop automatically.

The center button (Continuous) brews continuously until the user stops it by pressing the button again.

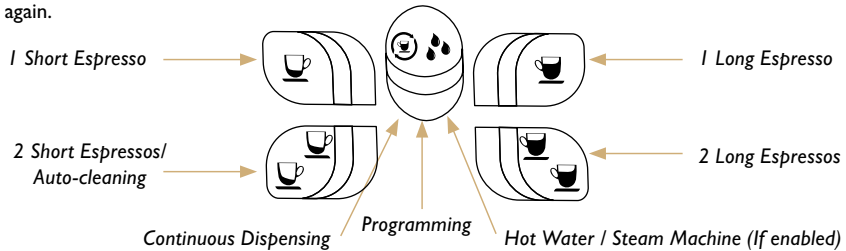

The Continuous Dispensing button performs 3 different functions (depending on length of time pressed):

Machines equipped with display





- Under 1 second: Enables automatic water- or steam-dosing (only on machines without manual taps).
- Between 1 and 8 seconds: Enables Continuous Dispensing (press again to disable).
- Over 8 seconds: Accesses the coffee-dose programming menu (see below).

Machines not equipped with display

- Under 4 seconds: Enables Continuous Dispensing (press again to disable).
- Over 4 seconds: Accesses the coffee-dose programming menu (see below).

Additional button functions

To activate these functions, turn off the machine at the power switch then, while holding down the required button on the left-hand Drink buttons, turn the machine back on.

-  1 Short Espresso. Enable electronic pre-infusion.
-  1 Long Espresso. Disable electronic pre-infusion.
-  2 Short Espresso. Perform auto-cleaning.
-  2 Long Espresso. Power on / off alternative lights (MINI machines only).



Note:

For machines equipped with a display, electronic pre-infusion may have to be enabled/ disabled from the service programming menu.

Programming the coffee dosage

To program the coffee doses dispensed automatically by each drink button follow the steps below:



Important:

Use a portafilter filled with fresh coffee for every new dose to be programmed.



- On machines not equipped with a display, press and hold the Continuous Dispensing button for 4 seconds, all of the drink buttons lights will be turned on. On machines equipped with a display, press and hold the Continuous Dispensing button for 8 seconds, the Continuous Dispensing button light will flash.
- Press the dispensing option that you wish to program: 1 Short Espresso, 1 Long Espresso, 2 Short Espressos or 2 Long Espressos. The lights on the pressed button and the Continuous Dispensing button will remain on.
- The group will start dispensing coffee. When the desired volume is reached in the cup, press the selected button again to stop dispensing. This volume setting will be saved. On machines equipped with a display, the lights on the reprogrammed dosage buttons will remain off.
- Repeat this process for all of the dispensing options that you wish to reprogram.

If you only need to reprogram one of the dispensing options, follow the steps above and program just that option. All of the other dispensing options will remain unchanged (default settings).



Note:

Programming any of the options on the left-hand-side drink buttons bank (when viewing the machine from the front) automatically sets the dispensing volumes on all of the other drink buttons. This only applies to the left-hand-side drink buttons. Programming other groups's drink buttons only modifies the option selected.

Machine status

Machines equipped with a display include the following additional functions:

- Automatic daily on/off timer (stand-by function).
- Clock settings (current time and date).
- Welcome message.
- Number of coffees/infusions dispensed.
- Digital boiler-temperature display and control.
- PID-technology boiler-temperature control.
- Programming and settings help system.
- Visual water-softener regeneration alarm.
- Display language selector.

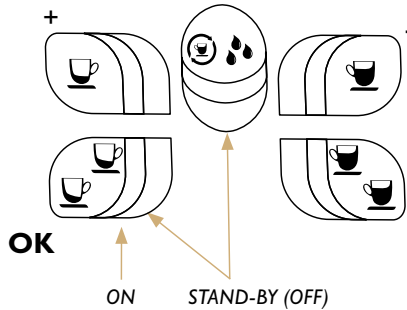

The machine has 3 different statuses:



- **ON**
The machine is active and ready for use. Generally when switching on the main switch, the machine will enter this status quickly. (See “ON” fig.04)
- **STANDBY**
The main switch is turned on, but the machine’s display reads OFF (See “STANDBY” fig.05). This is a power saving mode. To get to this status, begin with the machine in ON status. Press and hold the Continuous button  and, without releasing it, simultaneously press the 2 Short Espressos button . To exit this mode and turn the machine back on, then press the 2 Short Espressos button  again.
- **Off:**
The machine is totally powered down or electricity is disconnected.



fig. 04



fig. 05



Accessing the second level menu functions

Doses setting
Select within 30s

fig. 06

Set clock

fig. 07











- With the machine on, press the Continuous Dispensing button  on the Left-hand-side Drinks bank buttons and hold it down (for over 8 seconds) until the dose-programming menu is displayed. All the drink buttons lights will be turned on and the Continuous Dispensing button light will flash. The display will be as shown in fig. 06.
- Hold down the Continuous Dispensing button  until the menu displays the “set clock” option (see fig. 07).

This provides access to the second menu level.

Setting the clock: hours, minutes and day

Clock adjust
hh:mm Day

fig. 08







- To set the clock, press the 2 Short Espressos button  while the “Set clock” message is displayed.
- The hours values will start flashing. Increase/decrease the values by pressing the 1 Short Espresso  and 1 Long Espresso  buttons (see fig. 08).
With the desired value is reached, accept it the pressing the 2 Short Espressos button .
- The minutes digits will now start flashing. Increase/decrease the values by pressing the 1 Short Espresso  and 1 Long Espresso  buttons.
With the desired value is reached, accept it the pressing the 2 Short Espressos button .
- Set the day of the week in the same way (,  and ).

After setting the values, pressing the 2 Short Espressos button  accesses the auto On/Off menu.

Auto On/Off

Auto On/Off
On: hh.mm

fig. 9

- After accepting the changes made in the “set clock” menu, pressing the 2 Short Espressos button  accesses the coffee machine’s auto on/off programming menu (see fig. 09).
- To change the auto on/off time, increase/decrease the values (hours) using the 1 Short Espresso  and 1 Long Espresso  buttons while the values are flashing. When the desired value is reached, press the 2 Short Espressos button  to accept it. Set the values for the minutes in the same way (,  and ).

Note:









By default, this setting is set as: On: - - - - (indicating that the function is disabled). Changing the value to anything other than - - : - - enables the function. To leave this function disabled, press the 2 Short Espressos button  while the value selected is - - : - -.

Auto On/Off
Off: hh.mm

fig. 10

Closed On
Day

fig. 11

- While the auto off time is flashing, increase/decrease the values by pressing the 1 short espresso  and 1 Long Espresso  buttons. When the desired value is reached, press the 2 Short Espressos button  to accept it. The minutes values will start flashing. Set these values in the same way as described above (,  and ). After accepting the time, the next menu will be displayed.
- If auto on/off is enabled, it will also be possible to set a day on which the machine will not be turned on automatically. This option will not be displayed if auto on/off is disabled.
- To set the day off (see fig. 11), increase/decrease the values by pressing the 1 Short Espresso  and 1 Long Espresso  buttons. When the desired value is reached, press the 2 Short Espressos button  to accept it.

Note:





By default, this setting is set as: On: ----- (indicating that the function is disabled). Changing the value to anything other than ----- enables the function. To leave this function disabled, press the 2 Short Espressos button  while the value selected is -----.

Counters

Counters

fig. 12

- To access the counters menu, go to the start of the second menu level (see page 32, fig. 07).
- Press the Continuous Dispensing button  until the “Counters” option is displayed (see fig. 12).
The machine has 4 counters:
 - Litres: volume of water dispensed by the machine (indicator used for descaling maintenance cycles).
 - Service: number of coffees dispensed (indicator used for servicing).
 - Number of coffees/infusions dispensed.
 - Number of coffees dispensed per button.

| | |
|---|--|
| <p>Flow meter Gr. X</p> | <p>Fault in flow meter X / Flow fault detected in counter X</p> |
| <p>Time-out alarm Boiler filling up</p> | <p>Check that the machine is receiving water.</p> |
| <p>Probe unconnect</p> | <p>Temperature sensor fault</p> |
| <p>Service 999999999</p> | <p>Service the machine. To disable the alarm and reset the counter: Turn off the machine. Simultaneously press and hold the 1 Short Espresso  and 1 Long Espresso  buttons. Turn on the machine.</p> |
| <p>Change filter 999999999</p> | <p>Regenerate the filter: To disable the alarm and reset the counter: Turn off the machine. Simultaneously press and hold the 2 Short Espressos  and 2 Long Espressos  buttons. Turn on the machine.</p> |

- If boiler filling time exceeds the programmed time (2 minutes), all of the Drink buttons lights will flash and the machine will be disabled. To re-enable it, turn the machine off and on again at the power switch.
- If the electronic control panel does not receive a pulse from the flow meter (i.e.: coffee grind is too fine or flow meter fault) within 5 seconds of pressing one of the espresso buttons, the light for the dose selected will start to flash. To disable it, press the dose button again.
- As an additional safety, all dose settings have a maximum dispensing time of 5 minutes.

The following checks can be carried out by users only after the machine has been turned off and disconnected from the power supply. For all other nonspecific machine faults, disconnect the machine from the power supply and immediately contact authorised and qualified service personnel.

| Problem | Possible cause | Solution |
|--|---|--|
| The machine does not start up | The plug is not correctly inserted into the power socket | Check that the plug is correctly inserted and that the power socket is operational. |
| | The circuit breaker and/or differential are disconnected. | Check that they are connected. |
| | The cable and/or plug are damaged. | Call service personnel to replace them. |
| The steam wand does not dispense steam | The steam wand is clogged by milk | Clean the wand and, if necessary, remove the nozzle and unclog it using a pin or needle. |
| Water is found underneath the machine | The drainage tube is blocked. | Clean the drainage tube. |

| Faults produced by limescale | |
|---|---|
| Coffee not dispensed at right temperature: | Heat-exchanger outlet pipes clogged by limescale. |
| Brewing groups do not dispense water: | Water system is clogged by limescale. |
| <i>90% of faults are due to limescaling inside the coffee machine (due to not softening the water). To avoid these faults, maintain the water softener regularly.</i> | |

| Coffee-grinding problems | |
|---------------------------------|--|
| Coffee dispensing is very fast: | The coffee grinding is too coarse. Adjust the coffee-grinding setting. |
| Coffee dispensing is very slow: | The coffee grinding is too fine. Adjust the coffee-grinding setting. |

For the warranty to be valid the conditions for maintenance must have been followed according to our instructions, proper precaution has been made and warranty claim been issued without delay.

The affected equipment may not be used during awaiting service if there is any risk that the damage or defect would worsen.

The warranty will not cover consumption supplies such as glassware, normal maintenance such as cleaning of filters, contaminations in water, lime, incorrect voltages, pressure or adjustment of water amounts.

The warranty will not cover damages of defects caused by incorrect handling and operation of the appliance.

FOR SERVICE
Please contact your dealer

Your dealer



www.creminternational.com