

**ALTO-SHAAM®**

**Combitherm®  
Combination Oven/Steamer**



***CT Express™***

**CTX4-10E  
CTX4-10EVH  
CTX4-10EC  
CombiOven**



shown with ExpressTouch™ control

## **Step-By-Step Cooking Guide and Operation Manual**

W164 N9221 Water Street • P.O. Box 450  
Menomonee Falls, Wisconsin 53052-0450 U.S.A.

PHONE: 262.251.3800 • 800.558.8744 U.S.A. / CANADA  
FAX: 262.251.7067 • 800.329.8744 U.S.A. ONLY  
[www.alto-shaam.com](http://www.alto-shaam.com)



Consult instructions  
for operation and use.



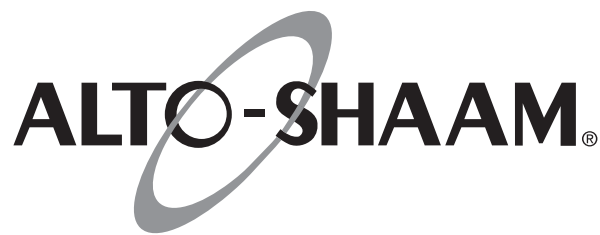

## Introduction

EcoSmart Technology	1
Simple Control	1
ExpressTouch™	2
Safety Precautions	3

## ExpressTouch™ Operating Instructions

Start-Up Procedures	4
Main Menu Screen	4
Settings Screen	6
Upload/Download Screen	7
Cooking Mode Screen	8
Factory Default Settings	10
Steam Mode	11
Combination Mode	13
Convection Mode	15
Retherm Mode	17
Broiler Mode (optional)	19
Core Temperature Probe Mode (optional)	20
Calibrating ExpressTouch Probe	20
Core Temperature - Delta-T (optional)	21
CombiSmoker Procedures	22
Ventless Hood Model	24
Auxiliary Functions	25
Using Preprogrammed Recipes	27
Recipe Programming	28
Bakery Recipes	29
Convenience Product Recipes	30
Fish & Seafood Recipes	32
Meat Recipes	33
Miscellaneous Recipes	35
Poultry Recipes	36
Vegetable Recipes	37
HACCP Access	39
Simple Control Panel Identification	40
Simple Control Operating Instructions	41

## Cleaning & Maintenance

Cleaning Agents	42
Precautions	42
First Aid	42
Preventive Maintenance	43
Preventative Maintenance	44
Protecting Stainless Steel Surfaces	50
Cleaning Schedule	51
Probe Usage and Cleaning	51
Ventless Hood Filters	52
ExpressTouch with CombiClean®	53
Simple Control with CombiClean®	54
Cleaning without CombiClean®	55

## Trouble Shooting

Emergency Operation Mode	56
Error Codes	57

# INTRODUCTION

## Ecosmart® Technology



The Alto-Shaam CT Express Combitherm combination oven/steamer employs Ecosmart operating efficiencies in the design and application of all operating and programming functions. Ecosmart operational characteristics include the use of a water barrier to close the oven compartment to the outside air. While maintaining a non-pressurized atmosphere, the primary purpose of the Ecosmart system is to prevent the steam and heat generated within the oven compartment from freely escaping to the outside.

The Ecosmart design displaces the air within the cooking compartment and achieves a higher level of steam saturation that offers quick-steaming at temperatures above 212°F (100°C).

This guide is provided as an operational aid with step-by-step instructions of the basic functions of the Combitherm oven, along with the many other additional features of the control.

## Simple Control

The Combitherm Simple control features a simple, Press button control that commands all the oven functions. Whether you cook by time, or cook using the optional product probe, rest assured you will be able to bake, roast, steam, poach, grill, broil, proof, braise and oven fry with confidence.

**LED display** - Easy to read display indicates temperature settings, time remaining, and various instructions.



STEAM MODE



COMBINATION MODE



CONVECTION MODE

# INTRODUCTION

## ExpressTouch™ Control

The Combitherm ExpressTouch control features a simple, graphics-based control panel that commands all the oven functions. Access up to 250 of your titled recipes. Manual Cooking by Time and temperature also are easily accomplished.

**Intuitive interface** - The Alto-Shaam ExpressTouch offers a simple interface that commands all of the Combitherm's cooking functions. As the name implies, it is fully operable by touch.

**Graphic controls** - The highly visual graphic-based control with logical procedures ensure that correct steps are followed every time.

**An excellent memory** - Access up to 250 of your titled recipes. The CT Express with ExpressTouch also comes standard with more than 100 pre-programmed recipes covering most commonly prepared food items.

### HACCP data access (option) -

The CT Express with ExpressTouch offers a downloadable HACCP function.

**Six levels of Gold-n-Brown™** - Six precise and consistent browning levels are standard with the ExpressTouch. The exclusive Gold-n-Brown feature gives the operator the ability to achieve the ideal cooking environment for the ideal finish.

**Superior baking** - The two-speed fan provides consistent baking results. A moisture injection feature provides perfect sheen and crust on breads and pastry items.

**Multi-shelf timers** - Track cooking time of different food items in the same oven with multi-shelf timers. Time is tracked in minutes and seconds.

**On-board diagnostics** - The ExpressTouch system includes on-board diagnostic functionality with results displayed right on the touchscreen.

**Reduced energy setting** - ExpressTouch features an interactive control display with reduced energy setting.



**STEAM MODE**



**COMBINATION MODE**



**CONVECTION MODE**



**BROILER MODE**



**REThERM MODE**

**NOTICE:** In a food service application, the catalytic converter technology does have limitations that are specific to recommended use (product type and volume of food produced). Application, both menu type and production, are limited. Overproduction and overcooking may result in exceeding conversion capability of the catalytic system and proper use should be exercised. Additionally, the catalytic converter system will not capture steam emission (during normal steam and/or combination cooking modes) from the oven cavity when the oven door is opened.

This product conforms to the ventilation recommendations set forth by NFPA96 using EPA202 test method. The oven shall be used for the cooking or warming of pizza, bread, bakery products, or similar items only. No raw animal protein products (skin-on poultry, ground meats, bacon, sausage, steak, etc) shall be cooked in the equipment unless mechanical ventilation is provided. Precooked foods such as animal, fish, or skinless poultry protein products may be reheated in the oven. The oven must be operated in a well-ventilated area approved for food preparation. If cooking fatty proteins, it is recommended that the local HVAC codes and authorities are consulted to ensure compliance with ventilation requirements. Ventless allowance is subject to and dependent upon local jurisdictional approval and some jurisdictions may not recognize the NSF/UL certification or application.

# INTRODUCTION

## Important Safety Precautions

- NOTICE:**
- Automatic steam venting is a standard safety feature built into all Combitherm oven models. This feature vents all steam from the oven compartment immediately before cooking time expires or set probe temperature is reached.
  - Automatic steam venting does not function if the oven door is opened before time expires or when the oven has been set to continuous operation.



- Use authorized Combitherm oven cleaner only. Unauthorized cleaning agents may discolor or harm interior surfaces of the oven. Read and understand label and material safety data sheet before using the oven cleaner.

### For Operator Safety

Note and observe all safety precautions located throughout this guide.



## WARNING

### HOT STEAM CAUSES BURNS

Rotate the door handle to release the door latch. Wait until the steam is vented before fully opening the door.



## WARNING

**DO NOT** handle pans containing liquid or semiliquid products positioned above the eye level of the operator. Such products can scald and cause serious injury.

## CAUTION



To prevent SEVERE PERSONAL INJURY or PROPERTY DAMAGE:

**ALWAYS** use hand protection when operating this appliance to avoid burns. Metal parts of this equipment become extremely hot when in operation.

## DANGER



To prevent serious personal injury, death, or property damage:

**Do not** steam clean, hose down or flood the interior or exterior with water or liquid solution of any kind. **Do not** use water jet to clean. Failure to observe this precaution will void the warranty.

## CAUTION



To prevent INJURY or PROPERTY DAMAGE, make certain the area around the appliance is kept clear of combustible items.



## CAUTION

**DO NOT** use the attached hand-held hose to spray anything other than the interior of the combitherm oven compartment.

**DO NOT** use the spray hose on the surface of a hot cooking compartment. allow the oven to cool to a minimum of 150°F (66°C).

## WARNING



**DO NOT** obstruct or block exhaust flues or attach any flue extension that may impede proper burner operation, restrict the exhaust fumes and cause negative backdraft or the appliance to shut down. Failure to do so may result in serious injury or death.

# EXPRESSTOUCH OPERATING INSTRUCTIONS

## Start-Up Procedures



When the oven is powered on, the ExpressTouch screen illuminates. "Loading" indicates that the software is booting up. The screen will also indicate what level of progress has been made as the software becomes fully operational.

### Main Menu Screen

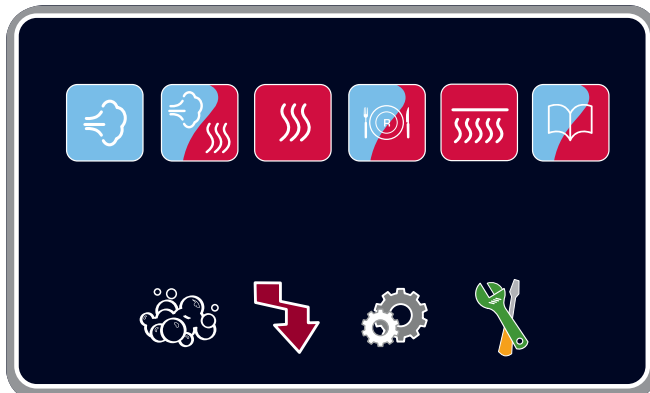

#### Cleaning Mode (optional)

Four (4) cleaning levels are available: rinse, light, normal, and heavy-duty cleaning.



#### Download/Upload Files and HACCP Access (optional)

Download all preprogrammed recipes (factory default and user-programmed) and HACCP data to a USB memory stick.



#### Settings

Change factory default settings. *See next page for more information.*



#### Service Mode (password protected)

This mode is only available to qualified service technicians.

# EXPRESSTOUCH OPERATING INSTRUCTIONS

## CT Express Start-Up Procedures

1. Turn on exhaust hood.
2. Turn on water supply.
3. Turn on main electrical power to appliance.
4. Push the power button on the appliance control panel.



The oven will automatically heat to a stand-by mode temperature of 188°F (77°C).

**NOTICE:** To power off the appliance, push and hold the power icon until the red LED illuminates to initiate power shut-down sequence to the oven. Oven will not shut down during a cooking cycle. ONLY if the control is unresponsive, firmly press and hold the power button. The unit will forcibly shut down 10-seconds after the red LED illuminates.

If, for any reason, the oven is turned off or loses power during this start-up process, the operator will be prompted to calibrate the touchscreen when the oven is next powered up.

 **Return to Home Screen** - Touch the red arrow if the touchscreen **does not** need to be calibrated.

 **Begin Calibration Process** - Touch the green check mark if the touchscreen **does need** to be calibrated. The screen will switch to a grey background. A crosshair icon will appear. The operator should touch the center intersection using a stylus for an accurate calibration. This prompt and required action will be repeated several times in different areas of the touchscreen. When complete, the operator will be returned to the home screen.

**NOTE:** In the event of a power failure, the oven will not operate.

**\*TO CALIBRATE, TOUCH THE CROSS HAIRS, NOT THE WORDS.**



CALIBRATE  
CALIBRER  
CALIBRACIÓN  
EICHEN  
校准  
교정  
КАЛИБРОВКА

CALIBRATE  
CALIBRER  
CALIBRACIÓN  
EICHEN  
校准  
교정  
КАЛИБРОВКА



# EXPRESSTOUCH OPERATING INSTRUCTIONS

## Settings Screen

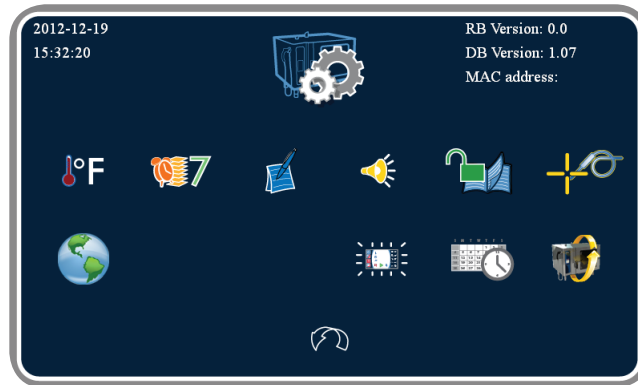

**Fahrenheit or Celsius Function** - Choose temperature format.

**Notice:** After choosing your format, return to the Main Menu screen and Press Oven Power switch to OFF.



**Language Choice** - English, Spanish, Mandarin, French, German, Korean and Russian are available.



**Multi-shelf Timer Number of Shelves** - Choose the default number of items in the oven to be used by the multi-shelf timer.



**Default Memo** - Revert time/temperature setting to factory defaults when switching modes or keep the last user setting.



**Sound/Alarm Settings** - Change alarm sounds and volume.



**Touchscreen Brightness** - Adjust brightness of display screen.



**Lock/Unlock Recipes** - Password protect preprogrammed recipes.



**Set/Change Date & Time** - Set or change oven time and date settings.



**Calibrate Product Probe (optional)**



**Software update** - Upload new control software to the oven using a USB drive.



**Return to Previous Screen** - Return to previous screen when finished adjusting settings.

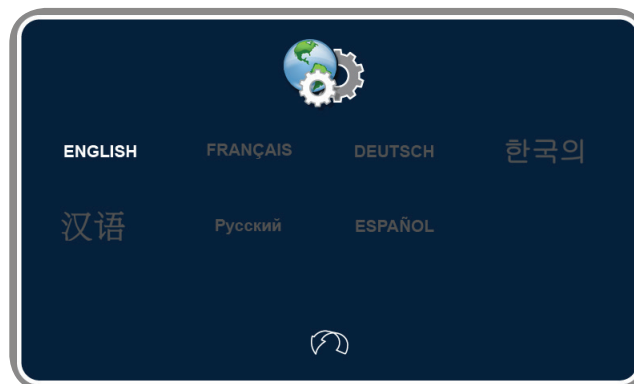



# EXPRESSTOUCH OPERATING INSTRUCTIONS

## Upload/Download Screen

Alto-Shaam ExpressTouch Software Download Form

CT EXPRESS COMBITHERM OVEN EXPRESSTOUCH SOFTWARE DOWNLOAD CENTER

The current software version is 1.27 (as of 01/22/2016)

For CTX4-10E, CTX4-10EVH & CTX4-10EC models.

We are constantly striving to improve the operation and performance of our CTX4-10E ExpressTouch ovens. As a result, things change! And we want to tell you when they do so you have the most recent upgrades. By providing your email address, we can alert you when software and hardware updates are available.

Find A Local Expert | Request A Quote | Request A Demo | Live Chat

**Powerful tool** - The ExpressTouch control plays an important part in our continuous improvement process. New features and abilities can be uploaded to your oven as they become available. Visit our website's download link at:

<http://www.alto-shaam.com/en/expresstouch-download>

Or simply call our Service Department for assistance.

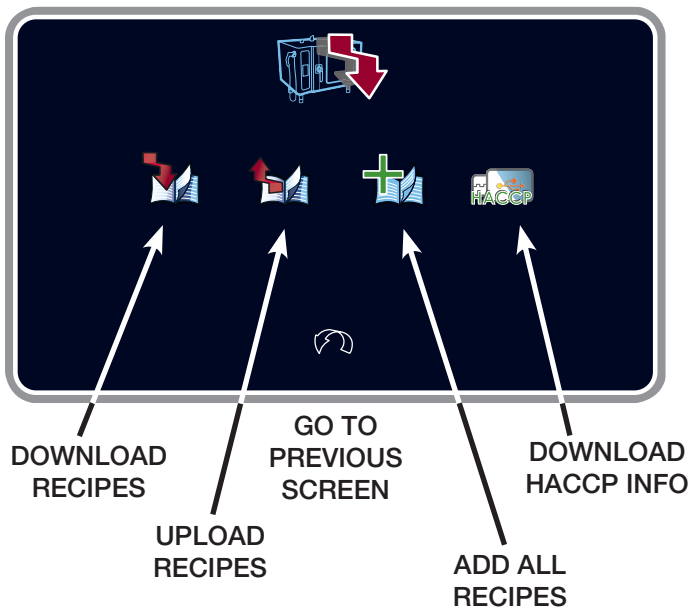

### Download Recipes

Copy *all* recipes from USB memory stick to oven. This will replace and overwrite existing recipes.



### Upload Recipes

Copy *all* recipes from oven control to USB memory stick.



### Add All Recipes

Copy *all* recipes from USB memory stick to the oven control. This will add the recipes to the beginning of the existing recipe list.



### HACCP Data (optional)

Download data to a USB drive for review in a .txt file format.

# EXPRESSTOUCH OPERATING INSTRUCTIONS

## Cooking Mode Screen

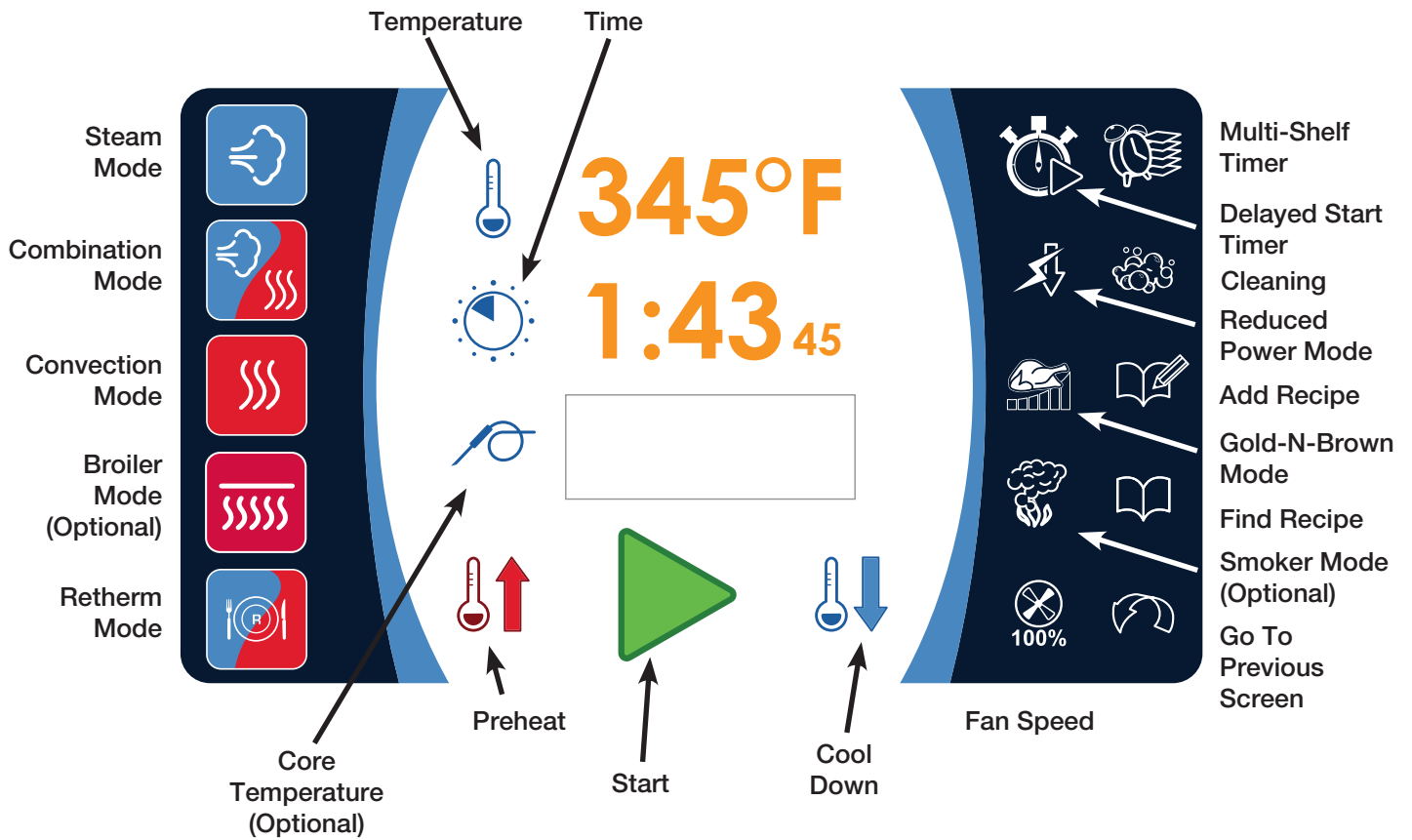

# EXPRESSTOUCH OPERATING INSTRUCTIONS

## Cooking Mode Screen Identification

### Main Menu Icons



#### Power ON/OFF button

Activates/deactivates power to the oven. It automatically fills the steam generator equipped models with water that will heat to a stand-by mode temperature of 188°F (77°C).

**NOTICE:** Oven will not shut down during a cooking cycle. Firmly press and hold the power button for 10 seconds to power down the oven ONLY IF the control has locked and is unresponsive.



#### Steam Mode

The oven will operate in the steam mode at a temperature range of 85°F to 250°F (30°C to 121°C).

- Automatic steaming at 212°F (100°C) factory-set default.
- Quick steaming between 213°F and 250°F (101°C and 121°C).
- Low temperature steaming between 85°F and 211°F (29°C and 99°C).



#### Combination Mode

Selection icon for cooking with a combination of steam and convection heat. Can be set between 212°F to 485°F (100°C and 252°C).



#### Convection Mode

Selection icon for convection cooking without steam at a temperature range of 85°F to 485°F (29°C to 252°C).



#### Broiler Mode (optional)

Quickly and efficiently toast or broil sandwiches, nachos, soups, and desserts with the top shelf broiling element.



#### Retherm Mode

Food rethermalization or reheating mode will operate with automatic steam injection at a temperature range of 245°F to 320°F (120°C to 160°C).



#### Temperature

Used to set the required cooking temperature, to recall the set cooking temperature, or to check the actual oven temperature.



#### Time

Used to set the required cooking time or recall the set cooking time.



#### Core Temperature (optional)

Used to set the required internal product temperature, to recall the internal product temperature set by the operator, or to display the current internal temperature of the product.



#### Preheat Mode

Preheats the oven cavity to a temperature set by user.



#### Cool Down Mode

Lowers temperature of the oven cavity at an accelerated pace to temperature set by user.



#### Delayed Start Time

Quick and simple way to begin preheating your oven while you're away, and ready to go when you are.



#### Start/Stop

Initiates all cooking mode functions and programmed procedures stored in memory. Stops an activated cooking mode or programmed procedure currently in progress.

# EXPRESSTOUCH OPERATING INSTRUCTIONS

## Auxiliary Function Icons



### Reduced Power Mode

Used to reduce kitchen power peaks and energy consumption.



### Gold-n-Brown Mode

This indicator will illuminate when the browning function is set by the operator in a timed or programmed cooking cycle in any mode. Level 1 provides least amount of browning, level 6 the most.



### Fan Speed

This indicator will illuminate whenever the operator sets a reduced fan speed to protect products affected by high-velocity air movement.



### Return to Previous Menu



### Add Recipe

Used to create, change, duplicate, and delete programmed menus.



### Find Recipe

Access a menu list of all stored cooking programs.



### Multi-shelf Timer

Use separate timers for one or more shelves in the oven compartment (only visible in time mode).



### Steam Injection (not shown on illustration)

Press to add moisture in any cooking mode. Steam will inject into the cavity as long as the icon is touched.



**Delta-T Core Temperature (optional) - only visible in certain modes** Cook by probe. Mode automatically adjusts cooking temperature in proportion to the internal temperature of the product.



**Smoking Mode (optional) - only visible in convection mode or combination mode.** This indicator will illuminate when the smoking function is set by the operator in a timer, probe or programmed cooking cycle.



### Rest

This step allows you to pause the oven during a program. The rest step is ideal for cold smoking. Infuse your food with smoke flavor after the actual smoking step has stopped.



## ExpressTouch Factory Default Settings

COOKING MODE	OVEN TEMPERATURE	CORE TEMPERATURE	COOKING TIME
Steam	212°F (100°C)	160°F (70°C)	25 minutes
Combination Steam	350°F (175°C)	160°F (70°C)	70 minutes
Convection	350°F (175°C)	160°F (70°C)	30 minutes
Broiler/Finishing (optional)	----- °F	N/A	--- : ---
Retherm (available on ExpressTouch only)	275°F (135°C)	160°F (70°C)	5 minutes

# EXPRESSTOUCH OPERATING INSTRUCTIONS

## Steam Mode

The Steam mode provides the operator with the ability to steam, poach, or blanch. This mode will automatically steam at the boiling point of water; quick-steam above the boiling point for faster cooking results; or low temperature steam, below the boiling point, for more delicate products such as pâté, mousse, seafood, or custard.

-  Press the **Power Button** to power oven on.
-  Touch the **Steam Mode** icon.  
The last set values or oven control default setting for temperature and time will appear in the display.
-  Touch the **Start** icon to cook at the displayed settings.

### Changing the Displayed Settings:

 Touch the displayed temperature.

The cooking temperature will appear at the top of the temperature selection window. Type in desired temperature or use up and down arrows to adjust temperature. When finished, touch the blue check mark icon  to confirm change.

- Automatic steaming 212°F (100°C)
- Quick steaming 213°F to 250°F (101°C to 121°C)
- Low temperature steaming 85°F to 211°F (29°C to 99°C)

### Cooking by Time:

 Touch the displayed time.

The cooking time will appear at the top the time selection window. Type in desired time period or use up and down arrows to adjust time. When finished, touch the blue check mark icon  to confirm change.

Or, to set **Continuous Operation** mode, touch the --:-- icon and touch the check mark icon to confirm.



### Cooking by Product Core Temperature:

-  Touch the **Probe** temperature field to the right of the icon.

The previously set core temperature or oven control default setting will appear highlighted within the oven display. Touch the displayed core temperature. The internal product core temperature will appear at the top of the temperature selection window. Type in desired internal product core temperature or use up and down arrows to adjust temperature. When finished, touch the blue check mark icon  to confirm change.

Attach removable probe before activating core temperature function, and insert into product.

-  Touch the green **Start** arrow icon to begin cooking in steam mode.

- The cavity set-temperature will appear in the display.
- If cooking by probe, the actual internal product temperature will appear next to the  icon during operation. To change the set value for core temperature, touch the temperature next to the  icon and make changes as required.

When the cooking time has expired or the operator set internal temperature has been reached, an alarm will sound indicating the end of the operating mode.

- To stop the alarm, touch the red **Stop** icon  or open the oven door.

 To stop a cooking program at any time, touch the red **Stop** icon.

# EXPRESSTOUCH OPERATING INSTRUCTIONS



## Operating Tips for Steam Mode

This mode will steam a full or partial load of a single product, or multiple products without transfer of flavors. When steaming multiple products, however, individual product cooking times must be taken into consideration.

The non-pressurized atmosphere of the Combitherm also provides the ability to open the door during the steam mode in order to monitor products more closely throughout the steaming process.

### Steam

Perforated, 2-1/2" (65mm) deep pans are particularly suitable for use in this program mode. These pans will provide a shorter cooking time and will prevent product over-cooking at the bottom of the pan.

Separate ice-encrusted vegetables before steaming to ensure even cooking.

A variety of products can be steamed at the same time but attention must be paid to the different cooking times required for each food product.

### High Temp Steam

High temperature steaming is suitable for hearty, root-type vegetables such as potatoes, turnips, carrots, and cabbage.

High temperature steaming provides a cooking time which is approximately 10% shorter than the regular steam mode temperature of 212°F (100°C).

Set the steam cooking temperature between 221°F (105°C) and 230°F (110°C) for small loads and between 230°F (110°C) and 250°F (121°C) for full loads.

### Low Temp Steam

The low temperature steam mode will function whenever the oven compartment temperature is below 212°F (100°C).

It will take longer to steam products using the low temperature steam mode.

Steaming sausages in low temperature steam prevents cracked or peeling skins.



Use low temperature steam for delicate foods such as shrimp, fish, seafood, and crème caramel.

For best results, low temperature steam all delicate food items at a temperature of 210°F (99°C) or below.

# EXPRESSTOUCH OPERATING INSTRUCTIONS

## Combination Mode

The Combination mode will prove to be the most versatile and widely used mode the Combitherm oven has to offer. It will produce the best possible results on the widest variety of products — all within the shortest period of time. The unique control function of this mode enables the operator to roast or bake with a combination of steam and convection heat. In addition to shorter cooking times, this combination of steam and heat offers less product shrinkage and more moisture retention than obtained in a standard convection oven.

-  Press the **Power Button** to power oven on.
-  Touch the **Combination Mode** icon.  
The last set values or oven control default setting for temperature and time will appear in the display.
-  Touch the **Start** icon to cook at the displayed settings.

### Changing the Displayed Settings:

-  Touch the displayed temperature.

The cooking temperature will appear at the top of the temperature selection window. Type in desired temperature or use up and down arrows to adjust temperature. When finished, touch the blue check mark icon  to confirm change.

- Cooking temperature range: 212°F to 485°F (100°C to 252°C)

### Cooking by Time:

-  Touch the displayed time.

The cooking time will appear at the top the time selection window. Type in desired time period or use up and down arrows to adjust time. When finished, touch the blue check mark icon  to confirm change.



Or, to set **Continuous Operation** mode, touch the --:-- icon and touch the check mark icon to confirm.

### Cooking by Product Core Temperature:

-  Touch the **Probe** temperature field to the right of the icon.

The previously set core temperature or oven control default setting will appear highlighted within the oven display. Touch the displayed core temperature. The internal product core temperature will appear at the top of the temperature selection window. Type in desired internal product core temperature or use up and down arrows to adjust temperature. When finished, touch the blue check mark icon  to confirm change.

Attach removable probe before activating core temperature function, and insert into product.

-  Touch the green **Start** arrow icon to begin cooking in combination mode.
  - The temperature and remaining cooking time will appear in the display.
  - If cooking by probe, the actual internal product temperature will appear next to the  icon during operation. To change the set value for core temperature, touch the temperature next to the  icon and make changes as required.

-  Touch for **Steam Injection** at any time during cooking. Steam will inject into the cavity as long as the icon is touched.

When the cooking time has expired or the operator set internal temperature has been reached, an alarm will sound indicating the end of the operating mode.

- To stop the alarm, touch the red **Stop** icon  or open the oven door.

-  To stop a cooking program at any time, touch the red **Stop** icon.

# EXPRESSTOUCH OPERATING INSTRUCTIONS



## Operating Tips for Combination Mode

The Combination mode injects the optimum amount of steam automatically. There is no need to select moisture levels. Foods do not dry out. Flavors are retained with no transfer of flavors when mixing product loads.

---

Due to automatic steam adjustment, the door can be opened at any time during a cooking operation. Be certain to observe the safety warning when opening the oven door.

---

The Combination mode is particularly efficient when used for baking, broiling, grilling, stewing, braising, and roasting.

---

When using the Combination mode, cooking temperatures can be reduced 10–20% below the temperatures used for conventional cooking methods.

---

Cooking time will be reduced approximately 40% when cooking at the same temperature used for convection oven cooking and up to 50–60% less time when cooking at the same temperature used for a conventional oven.

---

Food browning in the Combitherm begins at a cooking temperature of approximately 250°F (120°C).

---

A higher cooking temperature results in heavier browning but also results in greater product weight loss. To achieve additional browning, use the Moisture Vent option or set Gold-n-Brown into the product procedure. Gold-n-Brown is particularly useful for adding color to high moisture products such as chicken and other poultry items or for additional browning of full loads and other moist products.

---

The Combination mode provides even browning without the necessity to turn the pans.

---

For more even cooking, do not cook in pans deeper than 4" (100mm).



---



# EXPRESSTOUCH OPERATING INSTRUCTIONS

## Convection Mode

The Convection mode operates with hot circulated air within a temperature range of 85° to 485°F (29°C to 252°C). For many applications, better results may be achieved with the Combination mode; therefore, the operator may want to consider using the Convection mode on a more limited basis.

-  Press the **Power Button** to power oven on.
-  Touch the **Convection Mode** icon.  
The last set values or oven control default setting for temperature and time will appear in the display.
-  Touch the **Start** icon to cook at the displayed settings.

### Changing the Displayed Settings:

-  Touch the displayed temperature.

The cooking temperature will appear at the top of the temperature selection window. Type in desired temperature or use up and down arrows to adjust temperature. When finished, touch the blue check mark icon  to confirm change.

- Cooking temperature range: 85°F to 485°F (29°C to 252°C)

### Cooking by Time:

-  Touch the displayed time.

The cooking time will appear at the top the time selection window. Type in desired time period or use up and down arrows to adjust time. When finished, touch the blue check mark icon  to confirm change.





Or, to set **Continuous Operation** mode, touch the --:-- icon and touch the check mark icon to confirm.

### Cooking by Product Core Temperature:

-  Touch the **Probe** temperature field to the right of the icon.

The previously set core temperature or oven control default setting will appear highlighted within the oven display. Touch the displayed core temperature. The internal product core temperature will appear at the top of the temperature selection window. Type in desired internal product core temperature or use up and down arrows to adjust temperature. When finished, touch the blue check mark icon  to confirm change.

Attach removable probe before activating core temperature function, and insert into product.

-  Touch the green **Start** arrow icon to begin cooking in convection mode.
  - The temperature and remaining cooking time will appear in the display.
  - If cooking by probe, the actual internal product temperature will appear next to the  icon during operation. To change the set value for core temperature, touch the temperature next to the  icon and make changes as required.
-  Touch for **Steam Injection** at any time during cooking. Steam will inject into the cavity as long as the icon is touched.

When the cooking time has expired or the operator set internal temperature has been reached, an alarm will sound indicating the end of the operating mode.

- To stop the alarm, touch the red **Stop** icon  or open the oven door.

-  To stop a cooking program at any time, touch the red **Stop** icon.

# EXPRESSTOUCH OPERATING INSTRUCTIONS



## Operating Tips for Convection Mode

The Convection Mode can be used to roast or bake products needing very short cooking times or for high moisture products such as muffins, cakes, and cookies, or for browning the surface of the product.

---

The Convection mode works best with foods containing little moisture or for very moist food which require a dryer finished product.

---

For baking, preheat the Combitherm at a temperature of 325°F to 375°F (163°C to 191°C). Once preheated, reset the temperature as required.

---

A higher cooking temperature results in heavier browning but also results in greater product weight loss. To achieve additional browning use the moisture vent option or set the browning feature into the product procedure.



---

# EXPRESSTOUCH OPERATING INSTRUCTIONS



## Retherm Mode

The Retherm mode operates with hot circulated air within a temperature range of 245°F to 320°F (120°C to 160°C).

-  Press the **Power Button** to power oven on.
-  Touch the **Retherm Mode** icon.  
The last set values or oven control default setting for temperature and time will appear in the display.
-  Touch the **Start** icon to cook at the displayed settings.

### Changing the Displayed Settings:

-  Touch the displayed temperature.

The cooking temperature will appear at the top of the temperature selection window. Type in desired temperature or use up and down arrows to adjust temperature. When finished, touch the blue check mark icon  to confirm change.

- Cooking temperature range: 245°F to 320°F (120°C to 160°C)

### Cooking by Time:

-  Touch the displayed time.

The cooking time will appear at the top the time selection window. Type in desired time period or use up and down arrows to adjust time. When finished, touch the blue check mark icon  to confirm change.

Or, to set **Continuous Operation** mode, touch the --:-- icon and touch the check mark icon to confirm.



### Cooking by Product Core Temperature:

-  Touch the **Probe** temperature field to the right of the icon.

The previously set core temperature or oven control default setting will appear highlighted within the oven display. Touch the displayed core temperature. The internal product core temperature will appear at the top of the temperature selection window. Type in desired internal product core temperature or use up and down arrows to adjust temperature. When finished, touch the blue check mark icon  to confirm change.

Attach removable probe before activating core temperature function, and insert into product.

-  Touch the green **Start** arrow icon to begin cooking in retherm mode.

- The temperature and remaining cooking time will appear in the display.
- If cooking by probe, the actual internal product temperature will appear next to the  icon during operation. To change the set value for core temperature, touch the temperature next to the  icon and make changes as required.

-  Touch for **Steam Injection** at any time during cooking. Steam will inject into the cavity as long as the icon is touched.

When the cooking time has expired or the operator set internal temperature has been reached, an alarm will sound indicating the end of the operating mode.

- To stop the alarm, touch the red **Stop** icon  or open the oven door.

-  To stop a cooking program at any time, touch the red **Stop** icon.

# EXPRESSTOUCH OPERATING INSTRUCTIONS



## Operating Tips for Retherm Mode

Since plated meals consist of dissimilar products, there are several important factors to consider in order to produce the finest results. Product density (compactness), thickness, quantity of product on each plate, and quantity of plates all relate to the length of time necessary to reheat. Again, experience is the best method to determine reheating time. Once the time has been determined and recorded for a specific meal, the results will be consistent for future reheating times.

### Helpful Hints For Reheating On The Plate

- All food components on the plate should be of similar densities.
- All food components on the plate should be similar in thickness.
- Arrange all food components evenly on the plate.
- Avoid excessive overlapping of product.
- Sauces must be heated and added to product after reheating.
- A mixed variety of meals can be reheated at the same time.

### À La Carte Rethermalization

À la carte rethermalization is designed to take a single plate from a refrigerated temperature to serving temperature for immediate service. Plates are prepared in advance, covered, and refrigerated. Preheat the Combitherm oven. Remove plate from refrigeration and place in the oven at 275°F (135°C) for an uncovered plate or 300°F (150°C) for a covered plate. Plates with meat components will take more time than plates containing all vegetable components. Follow internal temperature requirements for reheating and allow for override time. After reheating, remove the plate from the oven, add any sauces, garnish, and serve. This process can be repeated as required.

For the most efficient continuous service, it is suggested that the Combitherm oven be dedicated to the rethermalization process during serving hours.

### Rethermalizing Prefabricated And Vacuum-Packed Frozen Foods

For bulk product rethermalization, completely defrost product bags in walk-in cooler. **Do not remove product from the bag.** Load thawed bags in preheated oven and rethermalize in the Low Temperature Steam mode until the required internal temperature is reached. Place rethermalized bags in a preheated holding cabinet set at 140°F to 165°F (60°C to 74°C) until ready for service.

**PLATE COVERS MUST BE USED FOR ON-THE-PLATE REGENERATION.**

# EXPRESSTOUCH OPERATING INSTRUCTIONS



## Broiling Mode (Optional)

The Broiler mode operates with an overhead broiling element perfect for quickly and efficiently toasting or broiling sandwiches, nachos, soups, and desserts.

1.  Press the **Power Button** to power oven on.

2.  Touch the **Retherm Mode** icon.

The last set values or oven control default setting for time will appear in the display. \_\_\_\_F will appear in the temperature field.

3.  Touch the **Start** icon to cook at the displayed settings.

2.  Touch the green **Start** arrow icon to begin cooking in broiler mode.

- The temperature (\_\_\_\_F) and remaining cooking time will appear in the display.
- When the cooking time has expired, an alarm will sound indicating the end of the operating mode.
- To stop the alarm, touch the red **Stop** icon  or open the oven door.

 To stop a cooking program at any time, touch the red **Stop** icon.

### Cooking by Time:

1.  Touch the displayed time.

The cooking time will appear at the top the time selection window. Type in desired time period or use up and down arrows to adjust time. When finished, touch the blue check mark icon  to confirm change.







Or, to set **Continuous Operation** mode, touch the --:-- icon and touch the check mark icon to confirm.







**NOTE:** Broiler mode does not allow the use of any auxiliary functions, such as smoking, Delta-T, water injection, energy levels, browning levels or shelf timers. Broiler mode will default to a fan speed of 50%.

# EXPRESSTOUCH OPERATING INSTRUCTIONS

## Core Temperature Probe Mode (Optional)

As an alternative to timer operation, the Core Temperature Probe mode can be used in conjunction with any program mode to cook by sensing internal product temperature using the included probe. For a more accurate internal temperature, an optional, specialized, Combitherm product probe senses temperature from four strategic points and displays a temperature average.

-  Press the **Power Button** to power oven on.
- Attach removable probe before activating core temperature function, and insert into product.  
  
The probe must be inserted so that the tip is positioned in the center of the food mass. For liquid or semi-liquid foods, suspend the probe in the center of the product and secure the probe wire to the edge of the container.
- Touch the required cooking mode icon. The last set values or oven control default setting for temperature and time will appear in the display.
-  Touch the **Start** icon to cook at the displayed settings.
-  Touch the displayed time.  
  
The cooking time will appear at the top the time selection window. Type in desired time period or use up and down arrows to adjust time. When finished, touch the blue check mark icon  to confirm change.
-  Touch the **Probe** temperature field to the right of the icon.  
  
The previously set core temperature or default setting will appear highlighted within the oven display. Touch the displayed core temperature. The internal product core temperature will appear at the top of the temperature selection window. Type in desired internal product core temperature or use up and down arrows to adjust temperature. When finished, touch the blue check mark icon  to confirm change.

-  Touch the green **Start** arrow icon to begin cooking.
    - The actual internal product temperature will appear next to the  icon during operation. To change the set value for core temperature, touch the temperature next to the  icon and make changes as required.
  -  Touch for **Steam Injection** at any time during cooking. Steam will inject into the cavity as long as the icon is touched.
    - When the operator-set internal temperature has been reached, an alarm will sound indicating the end of the operating mode.
    - To stop the alarm, touch the red **Stop** icon  or open the oven door.
-  To stop a cooking program at any time, touch the red **Stop** icon.



### Calibrate the ExpressTouch Oven Probe







- With the ExpressTouch oven on, fill a pitcher of ice water and place inside the combi oven.
- Insert the probe into the pitcher of ice water.
- Check the temperature by selecting the **Probe** button on the cooking mode menu.
- Once the temperature reading is 35°F (2°C), touch the back arrow button in the lower left hand corner of the screen to return to the main menu screen.
- Touch **Settings**.
- Touch **Probe**.
- Adjust the temperature control back 3 degrees using the minus button, then touch the back arrow to return to the **Settings** screen.
- The probe has now been calibrated to the correct temperature.

# EXPRESSTOUCH OPERATING INSTRUCTIONS

## Delta-T Core Temperature Cooking Mode (Optional)

This special program function cooks by internal product temperature with the use of the probe. Unlike the standard core temperature mode however, the Delta-T oven temperature automatically increases in direct proportion to the internal temperature of the product. The Delta-T mode can be used with both convection and combination modes, providing a more gentle method of cooking. Browning occurs toward the end of the cooking cycle.

-  Press the **Power Button** to power oven on.
- Insert probe into product.  
  
The probe must be inserted so that the tip is positioned in the center of the food mass. For liquid or semi-liquid foods, suspend the probe in the center of the product and secure the probe wire to the edge of the container.
- Touch the required cooking mode icon. The last set values or oven control default setting for temperature and time will appear in the display.
-  Touch the **Probe** temperature field to the right of the icon.  
  
The previously set core temperature or default setting will appear highlighted within the oven display. Touch the displayed core temperature. The internal product core temperature will appear at the top of the temperature selection window. Type in desired internal product core temperature or use up and down arrows to adjust temperature. When finished, touch the blue check mark icon  to confirm change.

-  Touch the **Delta-T** icon that appears in the lower right corner of the touchscreen.
  -  Touch the green **Start** arrow icon to begin cooking.
    - The actual internal product temperature will appear next to the  icon during operation. To change the set value for core temperature, touch the temperature next to the  icon and make changes as required.
  -  Touch for **Steam Injection** at any time during cooking. Each touch of the icon will release one pulse of steam.
    - When the operator-set internal temperature has been reached, an alarm will sound indicating the end of the operating mode.
    - To stop the alarm, touch the red **Stop** icon  or open the oven door.
-  To stop a cooking program at any time, touch the red **Stop** icon.

# EXPRESSTOUCH OPERATING INSTRUCTIONS

## CombiSmoker® Procedures

### Load Wood Chips

- Measure one container full of dry wood chips.
- Soak dry chips in water for 5-10 minutes.
- Shake excess water off wood chips.
- Place moistened chips back into the container and position the container securely on the two prongs located on the interior side panel of the oven.

A full container of wood chips will produce smoke for an approximate period of one to two hours depending on the cooking temperature being used for the selected product. The recommended Touch recipes have been tested to ensure complete product smoke penetration and full smoke flavor.

### Chef Operating Tip

Products such as ribs that require heavier smoke penetration to reach full smoke flavor should remain in the oven after cooking has been completed. Do not open the oven door.

Set the oven in the Low Temperature Steam Mode at 140°F to 160°F (60°C to 71°C) and allow the product to remain in the oven for a period of one hour.

**If you would like assistance, you are invited to contact an Alto-Shaam corporate chef for recommendations.**

**NOTICE:** Always keep the oven door closed whenever operating the smoking function.

The Touch CombiSmoker can be operated without using the smoking function. After using the oven as a smoker, however, it is necessary to clean the oven in order to prevent a transfer of smoke flavor to non-smoked products. Cleaning instructions are provided in this manual.

**NOTICE:** When smoking is completed, remove smoker box from oven. Dispose of wood chips in a fire proof waste receptacle to prevent the risk of fire.

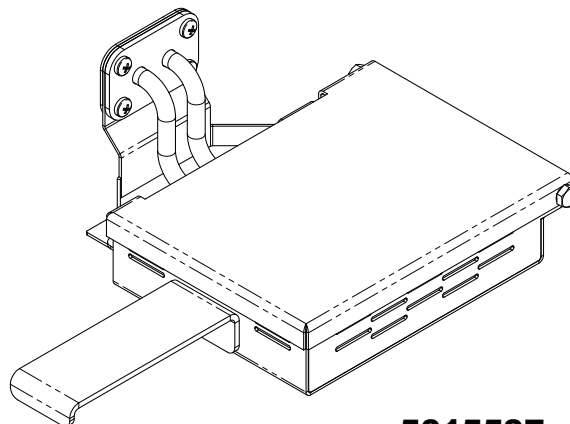

**5015597**

#### AVAILABLE FROM ALTO-SHAAM

WOOD CHIPS	20 pound bulk packs
THE TOTAL WEIGHT OF WOOD CHIP BULK PACKS MAY VARY DUE TO HIGH MOISTURE CONTENT WHEN PACKAGED.	<b>Apple WC-22543</b>
	<b>Hickory WC-2829</b>
	<b>Cherry WC-22541</b>
	<b>Sugar Maple WC-22545</b>



## CAUTION

**DO NOT** open the oven door during the smoking function. The introduction of outside air in the oven compartment may cause the wood chips to flame.



## WARNING

The use of improper materials for the smoking function could result in damage, hazard, equipment failure, or could reduce the overall life of the oven.

**Do not use sawdust for smoking.  
Do not use wood chips smaller than thumbnail size.**





# EXPRESSTOUCH OPERATING INSTRUCTIONS

## CombiSmoker® Procedures

The ability to smoke product, hot or cold, is offered as an option on the CTX4-10E CT Express oven. The smoking function can be engaged in either the Combination mode or the Convection mode of operation.

**NOTICE:** The fan will default to half speed. The smoking function cannot be operated when the oven is operating in the steam mode or the retherm mode.

1.  Press the **Power Button** to power oven on.
2.  Touch the desired cooking mode icon, **Combination** or **Convection**.





### Changing the Displayed Settings:

1.  Touch the area to the right of the temperature icon.
2. Type in desired temperature.

### Cooking by Time:

1.  Touch the area to the right of the time icon.
2. Type in desired time.

### To Activate CombiSmoke:

1.  Touch auxiliary function **Smoking** icon.
2.  Touch the **Start** icon to being smoking.

## CAUTION







To prevent **SEVERE PERSONAL INJURY** or **PROPERTY DAMAGE:**

**ALWAYS** use hand protection when operating this appliance to avoid burns. Metal parts of this equipment become extremely hot when in operation.

### Cold Smoking Procedure

1. Oven must be cooled to room temperature.
2. Place a full-size pan filled with ice on a shelf immediately above the smoker box.
3. Fill bottom of oven with ice.
4. Place food in oven and close door.
5. Press convection cooking mode icon.



6. Activate CombiSmoke:
  -  Touch auxiliary function **Smoking** icon.
7. Change The Displayed Settings:
  -  Touch the area to the right of the temperature icon.
  - Type in 32°F or 0°C
8. Cook By Time:
  -  Touch the area to the right of the time icon.
  - Type in desired smoke time.
  -  Touch the **Start** icon to being smoking.

### Chef Tip:

Leave food in smoke environment with oven door closed 10–60 minutes for penetration based upon your taste preference.

# EXPRESSTOUCH OPERATING INSTRUCTIONS

## VENTLESS HOOD MODEL

The Ventless Hood option is factory installed directly on the top of the Alto-Shaam Combitherm oven. The hood is designed to vent clean air back into the kitchen, filtering vapors and grease. A high-power fan draws steam and fumes into the hood intake and out the top surface exhaust vent. Fumes and vapors are circulated through filters. An activated charcoal filter cleans the air before venting it out the top of the hood.

### Operation

1. Turn the ventless hood power knob **ON**.
2. Indicator light will illuminate.
3. Wait five seconds, then press the Combitherm oven power **ON**.



### Filter Door Latch

Using a coin or screwdriver, turn to open; reverse procedure to close and latch.

Hood and oven will not operate unless this is closed properly.

### Indicator Light

If the indicator light does not illuminate, the filters may be missing or not properly aligned. Check them for proper positioning. Ventless hood and oven will not operate unless the hood is closed properly.

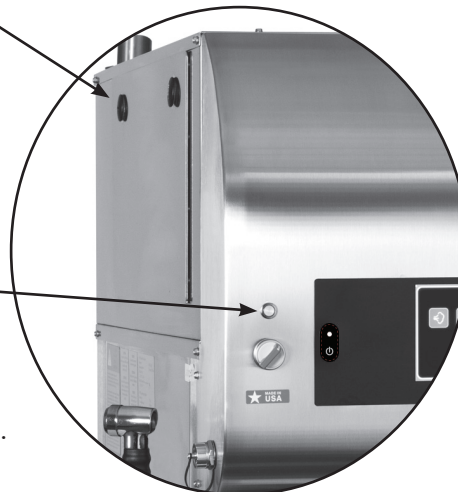

**Timed Latching Mechanism:** In order to evacuate steam and grease-laden air from the oven interior, this mechanism prevents the operator from fully opening the oven door for 20 seconds. Longer wait times can be programmed into the control. The mechanism automatically disengages at the end of a pre-set time allowing full door extension.

**Emergency Latch Release:** This release is to be used *ONLY* if the timed latch mechanism is not working or in the event of a power outage. Repeated use of the emergency release may damage the switching mechanism. Latch is located on the right side of the oven, toward the back.

# EXPRESSTOUCH OPERATING INSTRUCTIONS

## Auxiliary Functions

All auxiliary functions can be engaged at any time during any cooking mode and can be programmed into cooking procedures. At the end of a cooking mode or program, the oven automatically disengages all auxiliary functions.

### Preheating Feature

1. Select desired cooking mode.
2.  Touch the **Preheat** icon.

The preheat temperature will appear at the top of the preheat temperature selection window. Type in desired temperature or use up and down arrows to adjust temperature. When finished, touch the blue check mark icon  to confirm change.



When the preheat temperature has been reached, an alarm will sound indicating the end of the preheat function. To stop the alarm, touch the red **Stop** icon . The preheat temperature will be maintained if the stop icon is not pressed.

### Gold-n-Brown Feature

The browning feature is an automatic function designed to regulate humidity to provide additional color to products as needed. This feature is particularly useful for adding color to high moisture products, such as chicken and other poultry items, or for additional browning of full loads and other moist products. In addition, this feature may be used to add texture to fried items such as french fries or breaded chicken. Gold-n-Brown can be used in any cooking mode and can be programmed into a cooking procedure.

Browning can be used for any product. Depending on the type of product and product load, the browning feature may also slightly increase the set cooking time in order to fully complete the browning function. This is a standard operating condition of this feature.

1. Select desired cooking mode.
2. Adjust temperature and time settings.
3.  Touch the **Gold-n-Brown** icon.

4.  Choose the desired Gold-n-Brown level. (Level 1 provides least amount of browning, level 6 the most.) After a level has been selected, the previous screen will be displayed and the Gold-n-Brown icon will be highlighted.
5.  Touch the green **Start** arrow icon to begin cooking.

The oven will engage the browning feature in the cooking mode set by the operator. Gold-n-Brown can be used in steam mode to reduce moisture.

### Oven Cool Down Feature

The cool down feature provides the operator with the ability to lower the temperature of the oven compartment at an accelerated pace. This function is useful when it is necessary to immediately change from a high temperature cooking function to a lower temperature function or to the steam program. This function is also useful to help cool the oven compartment in preparation for cleaning.

### Chef Operating Tip

**When using the cool down feature in preparation for cleaning, it is important to remember that the temperature in the display indicates the air temperature inside the oven compartment and not the interior walls of the oven. Always allow the oven walls to cool to a minimum of 140°F (60°C) before spraying the compartment with oven cleaner.**

1.  Touch the **Cool Down** icon.

The cool down temperature will appear at the top of the cool down temperature selection window. Type in desired temperature between 50°F and 200°F (10°C and 93°C) or use up and down arrows to adjust temperature. When finished, touch the blue check mark icon  to confirm change.

2. Open oven door.

A alarm will sound indicating the end of the cool down function. Touch the red **Stop** icon  to stop the alarm.

# EXPRESSTOUCH OPERATING INSTRUCTIONS

## Auxiliary Functions

### Reduced Fan Speed

The reduced fan speed function is useful for flow-sensitive products such as soufflés and meringues, or any products affected by a high velocity of air movement.



1. Select desired cooking mode and set mode functions.
2.  Touch the **Fan Speed** icon.

The **Fan Speed** icon toggles between 100% and 50%.  
Broiler mode defaults to a fan speed of 50%.

3.  Touch the green **Start** arrow icon to begin cooking.

### Reduced Power

The reduced power function can be used to reduce kitchen power peaks and energy consumption.

1. Select desired cooking mode and set mode functions (not applicable to broiler mode).
2.  Touch the **Reduced Power** icon.
3. The reduced power icon will be highlighted.
4.  Touch the green **Start** arrow icon to begin cooking.



The oven will operate with reduced power in whatever cooking mode is set by the operator.

**NOTICE:** Reduced power will result in longer cooking times.

### Multi-Shelf Timer

The multi-shelf timer allows the operator to program alarm times for the oven shelves. This can be one common time for all shelves or individual times.

Set cooking mode, temperature and time. The time set by the user will be the default time for the shelf timers.

1.  Touch the **Multi-Shelf Timer** icon.
2. Adjust time settings for each shelf and press blue check mark icon  to confirm change.
3.  Touch the green **Start** arrow icon for each individual shelf. The unit will immediately start running in continuous operation mode.

When time expires for a shelf, the time background will turn red and an alarm will sound.

Open the door or touch the red **Stop** icon  to silence alarm. Remove food as appropriate.

### Steam Injection

1.  Touch to add moisture while in any cooking mode. Steam will inject into the cavity as long as the icon is touched.

# PREPROGRAMMED RECIPES

## Preprogrammed Recipes

The ExpressTouch Combitherm comes preprogrammed with more than 100 recipes covering most commonly prepared food items. ExpressTouch also allows you to save up to 250 of your recipes.

Navigate to desired recipe icon using NEXT and PREVIOUS SCREEN arrows. Touch recipe description for desired recipe. Cooking steps will start immediately. (See 29-38 for a list of all preprogrammed recipes.)

 Select **Recipe Mode** from any screen.

### Main Menu Screen

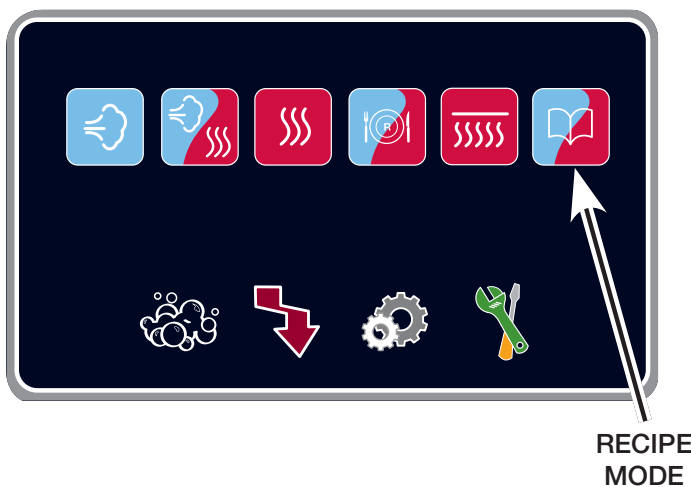

### Cooking Mode Menu

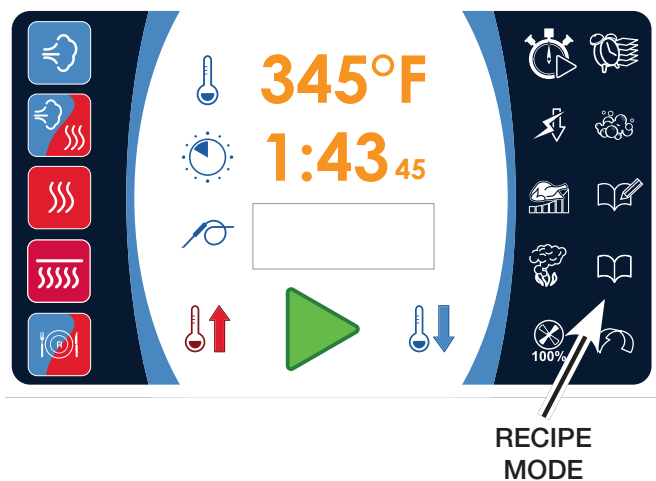

### Recipe Menu

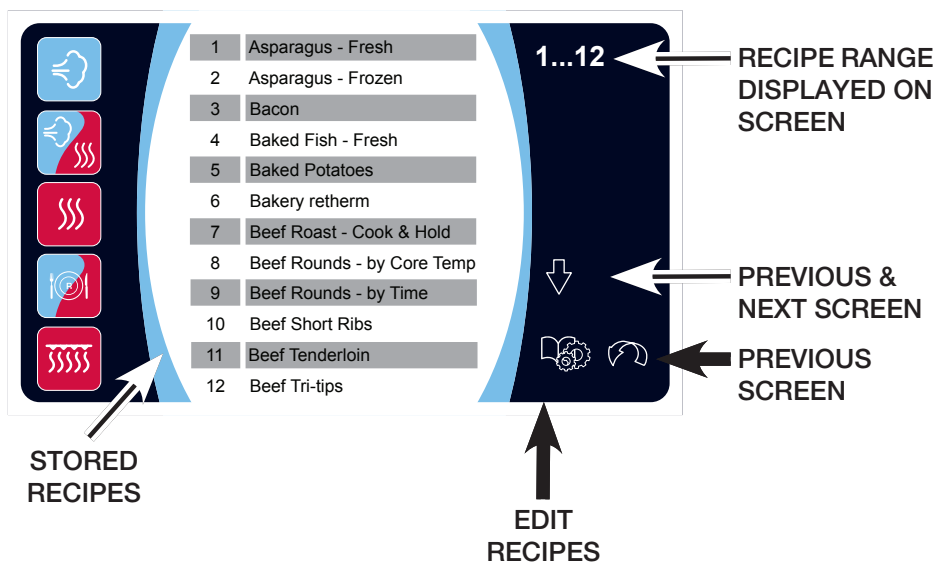





# PREPROGRAMMED RECIPES

## Recipe Programming Via The Touchscreen







### Add A Recipe

The recipe programming function allows the operator to program a cooking procedure using multiple cooking modes and any auxiliary functions desired. Recipes remain programmed until deleted by the operator.

1. Select any cooking mode.
2.  Touch **Add Recipe** icon.
3. Select first desired cooking mode. Last input temperature, time and probe setting is displayed.
4. Change temperature, time and/or cook by probe as desired.
5. Change auxiliary functions as desired (fan speed, Gold-n-Brown, etc.)
6. When finished with cooking step, touch the  **Write** icon. The next cooking step's programming screen is displayed.
7. Repeat steps 3 through 6 for each cooking step.
8. When finished programming a recipe, touch the  **Confirm Changes** icon.
9. A keypad will appear. Input name of recipe. Touch the  **Confirm Changes** icon.
10. The saved recipe will appear as the first recipe in the list.
11. Touch the newly saved recipe icon. Cooking steps in recipe will immediately start.

### Edit A Recipe

To edit an existing default or user-programmed recipe:

1.  Select **Recipe Settings Mode** from the Recipe Menu. The touchscreen background will turn red to indicate that the user is in **Edit Mode**.
2. Touch the recipe to be edited. The selected recipe will be outlined.
3. Touch  **Edit Recipe**. The first cooking step in the recipe is displayed.  
Or touch  **Delete Recipe** to remove recipe.  
Touch  **Confirm Changes** to confirm deletion.
4. Edit cooking mode, temperature, time, probe temperature, and/or auxiliary functions.
5. Touch  **Confirm Changes**. A keyboard will appear. Edit the title as appropriate.  
Touch  **Confirm Changes** at the bottom of the keyboard.
6. Touch  **Confirm Changes** at the bottom of the touchscreen to exit **Edit Recipe** mode.

# PREPROGRAMMED RECIPES

## Bakery Recipes

Recipe	Oven Mode	Temp	Time	Fan Speed	Browning
Bakery Retherm	Retherm	275°F (135°C)	4 minutes	100%	--
Brownies	Convection	325°F (163°C)	25 minutes	100%	--
Cinnamon Rolls	Combination	350°F (177°C)	20 minutes	100%	--
Cookies	Convection	325°F (163°C)	12 minutes	50%	--
Croissants	Combination	325°F (163°C)	15 minutes	50%	--
Danish Pastry	Combination	350°F (177°C)	15 minutes	100%	--
Dinner Rolls	Combination	350°F (177°C)	10 minutes	100%	--
French Bread	Combination	350°F (177°C)	20 minutes	100%	--
Fruit Bread	Combination	300°F (149°C)	50 minutes	100%	--
Fruit Pie	Combination	340°F (171°C)	30 minutes	100%	--
Muffins	Convection	325°F (163°C)	15 minutes	50%	--
Par-baked Bread (frozen)	Combination	340°F (171°C)	15 minutes	100%	--
Par-baked Rolls	Combination	350°F (177°C)	10 minutes	100%	--
Proofing	Low Temp Steam	90°F (32°C)	30 minutes	50%	--
Puff Pastry	Combination	350°F (177°C)	10 minutes	100%	--
Sheet Cake	Convection	325°F (163°C)	20 minutes	50%	--

# PREPROGRAMMED RECIPES

## Convenience Product Recipes

Recipe	Oven Mode	Temp	Time	Fan Speed	Browning
Chicken Wings	Combination	400°F (204°C)	10 minutes	100%	2
Corn Dogs	Combination	350°F (177°C)	18 minutes	100%	1
Egg Rolls	Combination	375°F (191°C)	15 minutes	100%	3
Frozen Entrée: Cabbage Rolls	Combination	350°F (177°C)	160°F probe (71°C)	100%	--
Frozen Entrée: Chicken Primavera	Combination	350°F (177°C)	160 minutes	100%	--
Frozen Entrée: Macaroni & Beef	Combination	350°F (177°C)	145 minutes	100%	--
Frozen Entrée: Macaroni & Cheese	Combination	350°F (177°C)	140 minutes	100%	--
Frozen Entrée: Meat Lasagna	Combination	350°F (177°C)	150 minutes	100%	--
Frozen Entrée: Ratatouille	Combination	350°F (177°C)	35 minutes	100%	--
Frozen Entrée: Stuffed Peppers	Combination	350°F (177°C)	150 minutes	100%	--
Hamburger Patties - Frozen	Combination	350°F (177°C)	12 minutes	100%	4
Hamburger Patties - Thawed	Combination	350°F (177°C)	5 minutes	100%	--
Hot Dogs - Low Temp Steam	Low Temp Steam	160°F (71°C)	13 minutes	50%	--
Hot Dogs - Steamed	Steam	212°F (100°C)	10 minutes	100%	--
Mini Pizza	Combination	350°F (177°C)	10 minutes	100%	--
Precooked Chicken Pieces - Frozen (MRB)	Convection	365°F (185°C)	30 minutes	100%	3

(CONTINUED ON NEXT PAGE)



# PREPROGRAMMED RECIPES

## Convenience Product Recipes (Continued)

<b>Recipe</b>	<b>Oven Mode</b>	<b>Temp</b>	<b>Time</b>	<b>Fan Speed</b>	<b>Browning</b>
Precooked Chicken Pieces - Refrigerated	Convection	325°F (163°C)	20 minutes	100%	1
Spring Rolls	Combination	375°F (191°C)	15 minutes	100%	--
Tater Tots	Combination	375°F (191°C)	10 minutes	100%	3

# PREPROGRAMMED RECIPES

## Fish & Seafood Recipes

<b>Recipe</b>	<b>Oven Mode</b>	<b>Temp</b>	<b>Time</b>	<b>Fan Speed</b>	<b>Browning</b>
Baked Fish - Fresh	Combination	400°F (204°C)	6 minutes	100%	2
Grilled Fish Fillets	Combination	460°F (238°C)	4 minutes	100%	--
Lobster - Whole	Steam	195°F (91°C)	13 minutes	50%	--
Salmon - Filets	Low Steam	145°F (63°C)	7 minutes	100%	--
Salmon - Steaks	Steam	145°F (63°C)	8 minutes	100%	--
Shrimp - Steamed	Low Steam	160°F (71°C)	12 minutes	50%	--

# PREPROGRAMMED RECIPES

## Meat Recipes

Recipe	Oven Mode	Temp	Time	Fan Speed	Browning
Bacon	Combination	375°F (191°C)	10 minutes	100%	--
Beef Roast Cook & Hold	(1) Delta-T	125°F (52°C)	Probe 120°F (46°C)	50%	--
	(2) Steam	135°F (57°C)	Continuous	50%	2
Beef Rounds - by Core Temp	Delta-T	130°F (54°C)	Probe 125°F (52°C)	100%	1
Beef Rounds - by Time	Combination	250°F (121°C)	130 minutes	100%	--
Beef Short Ribs	Combination	275°F (135°C)	90 minutes	100%	--
Beef Tenderloin	Combination	250°F (121°C)	Probe 125°F (52°C)	100%	2
Beef Tri-tips	Combination	250°F (121°C)	Probe 125°F (52°C)	100%	3
Breakfast Sausage Links	Combination	350°F (177°C)	8 minutes	100%	--
Grilled Pork Chops	Combination	460°F (238°C)	6 minutes	100%	1
Grilled Steaks	Combination	460°F (238°C)	Probe 130°F (54°C)	100%	--
Ham - by Core Temp	Delta-T	125°F (52°C)	Probe 150°F (66°C)	50%	--
Leg of Lamb - by Core Temp	Delta-T	125°F (52°C)	Probe 130°F (54°C)	100%	2
Meat Loaf - by Core Temp	Combination	275°F (135°C)	Probe 155°F (68°C)	100%	3
Pork - Back Ribs - Raw	Combination	250°F (121°C)	45 minutes	100%	--

(CONTINUED ON NEXT PAGE)

# PREPROGRAMMED RECIPES

## Meat Recipes (Continued)

<b>Recipe</b>	<b>Oven Mode</b>	<b>Temp</b>	<b>Time</b>	<b>Fan Speed</b>	<b>Browning</b>
Pork - Loin Roast - by Core Temp	Combination	300°F (149°C)	Probe 150°F (66°C)	100%	2
Pork Ribs Reheat	Combination	400°F (204°C)	7 minutes	100%	--
Rack of Lamb - by Core Temp	Delta-T	130°F (54°C)	130 minutes	100%	2
Sausage - Fresh - by Low Temp Steam	Low Temp Steam	160°F (71°C)	15 minutes	50%	--

# PREPROGRAMMED RECIPES

## Miscellaneous Recipes

Recipe	Oven Mode	Temp	Time	Fan Speed	Browning
Casseroles - by Core Temp	Combination	350°F (177°C)	Probe 150°F (66°C)	100%	--
Casseroles - Time	Combination	350°F (177°C)	30 minutes	100%	--
Custard/Crème Brulee	Low Temp Steam	190°F (88°C)	45 minutes	50%	1
Eggs - Hardboiled	Steam	212°F (100°C)	12 minutes	100%	--
Eggs - Poached - Low Temp Steam	Low Temp Steam	170°F (77°C)	5 minutes	50%	--
Eggs - Poached - Steamed	Steam	212°F (100°C)	3 minutes	100%	--
Eggs - Scrambled in bag; shake at 18 minutes	Steam	212°F (100°C)	25 minutes	100%	--
Eggs - Scrambled in pan	Steam	212°F (100°C)	15 minutes	100%	--
Eggs - Sous Vide	Steam	148°F (64°C)	45 minutes	50%	--
French Fries - Full Load	Combination	400°F (204°C)	1 minute	100%	4
	(2) Combination	400°F (204°C)	9 minutes	100%	2
Pasta	Steam	212°F (100°C)	20 minutes	100%	--
Pate en Croute - by Core Temp	(1) Convection	350°F (177°C)	10 minutes	100%	--
	(2) Combination	350°F (177°C)	Probe 135°F (57°C)	100%	--
Pizza - Fresh	Combination	400°F (204°C)	10 minutes	50%	1
Rice	Steam	212°F (100°C)	20 minutes	100%	--
Soup in Bag	Steam	230°F (110°C)	50 minutes	100%	--
Tamales	Steam	212°F (100°C)	30 minutes	100%	-

# PREPROGRAMMED RECIPES

## Poultry Recipes

Recipe	Oven Mode	Temp	Time	Fan Speed	Browning
Chicken - Frozen Pieces	Combination	350°F (177°C)	30 minutes	100%	3
Chicken - Oven Fried Pieces	Combination	450°F (232°C)	18 minutes	100%	--
Chicken - Thawed Whole	Combination	350°F (177°C)	35 minutes	100%	1
Chicken - Thawed Whole - by Core Temp	Combination	350°F (177°C)	Probe 175°F (79°C)	100%	1
Chicken baked - Thawed Pieces	Combination	375°F (191°C)	Probe 170°F (77°C)	100%	2
Duck Pieces - Raw	Combination	375°F (191°C)	25 minutes	100%	4
Duck Whole - by Core Temp	(1) Combination	250°F (121°C)	15 minutes	100%	--
	(2) Combination	300°F (149°C)	10 minutes	100%	--
	(3) Combination	400°F (204°C)	Probe 175°F (79°C)	100%	3
Galantine - by Core Temp	Low Temp Steam	160°F (71°C)	Probe 135°F (57°C)	50%	--
Grilled Chicken Breasts	Combination	460°F (238°C)	6 minutes	100%	--
Turkey Breast - Precooked - by Time	Combination	275°F (135°C)	Probe 155°F (68°C)	50%	--
Turkey Breast - Raw - by Core Temp	Combination	275°F (135°C)	Probe 155°F (68°C)	50%	1

# PREPROGRAMMED RECIPES

## Vegetable Recipes

Recipe	Oven Mode	Temp	Time	Fan Speed	Browning
Asparagus - Fresh	Steam	190°F (88°C)	3 minutes	50%	--
Asparagus - Frozen	Steam	212°F (100°C)	30 minutes	100%	--
Baked Potatoes	Combination	350°F (177°C)	40 minutes	100%	1
Beets - Fresh	Steam	230°F (110°C)	20 minutes	100%	--
Broccoli - Fresh	Steam	212°F (100°C)	6 minutes	100%	--
Broccoli - Frozen	Steam	212°F (100°C)	3 minutes	100%	--
Brussel Sprouts - Frozen	Steam	212°F (100°C)	6 minutes	100%	--
Cabbage - Fresh	Steam	212°F (100°C)	10 minutes	100%	--
Carrots - Fresh	Steam	225°F (107°C)	10 minutes	100%	--
Carrots - Frozen	Steam	212°F (100°C)	6 minute	100%	--
Cauliflower - Fresh	Steam	212°F (100°C)	5 minutes	100%	--
Cauliflower - Frozen	Steam	212°F (100°C)	4 minutes	100%	--
Corn (Kernels) - Frozen	Steam	212°F (100°C)	4 minutes	100%	--
Corn-on-the-Cob - Fresh	Steam	212°F (100°C)	14 minutes	100%	--
Corn-on-the-Cob - Frozen	Steam	212°F (100°C)	10 minutes	100%	--

(CONTINUED ON NEXT PAGE)

# PREPROGRAMMED RECIPES

## Vegetable Recipes (Continued)

Recipe	Oven Mode	Temp	Time	Fan Speed	Browning
Green Beans - Fresh	Steam	212°F (100°C)	8 minutes	100%	--
Green Beans - Frozen	Steam	212°F (100°C)	5 minutes	100%	--
Parsnips - Fresh	Steam	230°F (110°C)	10 minutes	100%	--
Peas - Frozen	Steam	212°F (100°C)	4 minutes	100%	--
Potatoes, Red or Salad	Steam	212°F (100°C)	30 minutes	100%	--
Squash - Fresh	Steam	212°F (100°C)	3 minutes	100%	--
Turnips - Fresh	Steam	230°F (110°C)	10 minutes	100%	--
Zucchini - Fresh	Steam	212°F (100°C)	3 minutes	100%	--



# EXPRESSTOUCH OPERATING INSTRUCTIONS

## HACCP Access

The ExpressTouch Combitherm meets the requirements of established HACCP criteria by providing automated sampling, record keeping, set-point validation, recipe used, dates and time. Data is captured when Core Temperature Probe cooking method is chosen. This information can be downloaded to a USB drive and then copied to your computer. The file format is text (.txt).

**NOTICE:** You can access this information from the Upload/Download Screen. See illustrations on page 6 for navigation.

**CAUTION:** The CombiOven USB port is not recommended for use with personal hand held devices.

1. To download the data collected, remove the cap of a USB port located on the side of the oven and insert the USB flash drive. If the flash drive is not recognized by the Combitherm, a question mark will appear on screen. Try again with another flash drive device or call Alto-Shaam Service.



2. Touch to download information.



3. Wait for the icon to change from loading to complete.



4. Touch to confirm transfer.
5. Remove the USB flash drive and replace the cap on the USB port.

The download process will automatically create a folder on the USB flash drive titled "haccp". Each text file contains cooking program specifics.

HACCP	
Unit:	00:30:D6:FF:28:63
Date:	2011-01-09
Program:	Steam
Start time:	22:10:31
Stop time:	22:14:37
Elapsed cook time:	00:04
Multi shelf timer:	no
Reduced energy:	no
Recipe active:	no
Temperature unit:	°F
Cavity start temperature:	191
Cavity stop temperature:	217
Cavity temperature reached:	00:02
Core start temperature:	176
Core stop temperature:	215
Core temperature reached:	00:00
Door open count:	0

# SIMPLE CONTROL OPERATING INSTRUCTIONS

## Control Panel Identification

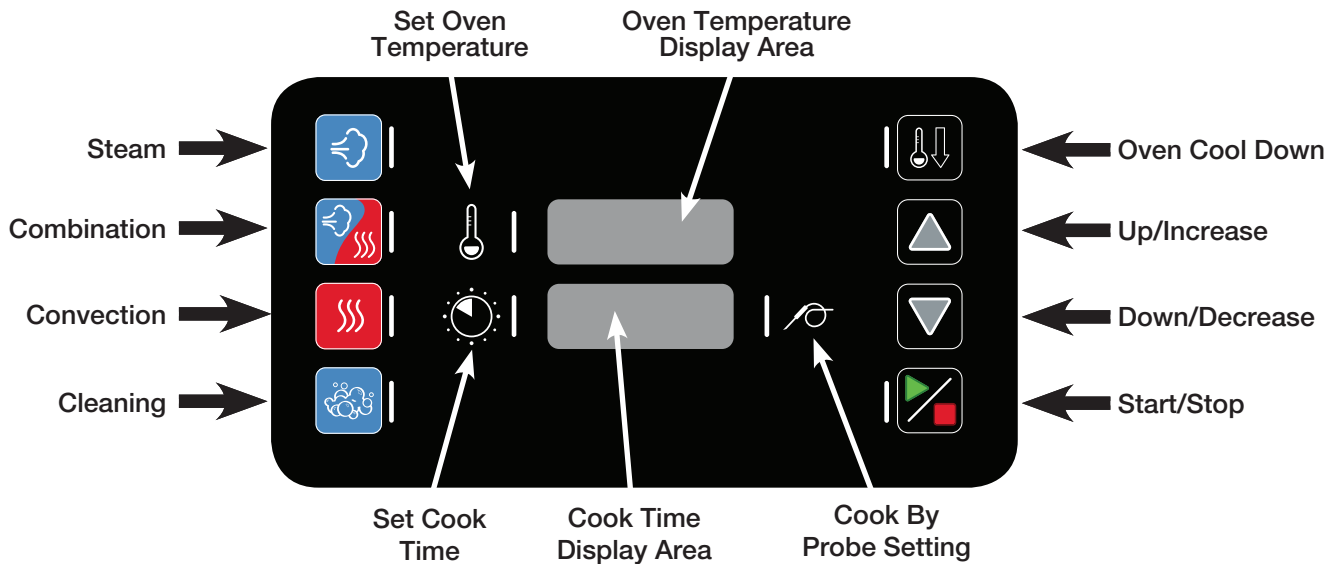

The Steam mode provides the operator with the ability to steam, poach, or blanch. This mode will automatically steam at the boiling point of water; quick-steam above the boiling point for faster cooking results; or low temperature steam, below the boiling point, for more delicate products such as pâté, mousse, seafood, or custard.

The Combination mode will prove to be the most versatile and widely used mode the Combitherm oven has to offer. It will produce the best possible results on the widest variety of products — all within the shortest period of time. The unique control function of this mode enables the operator to roast or bake with a combination of steam and convection heat. In addition to shorter cooking times, this combination of steam and heat offers less product shrinkage and more moisture retention than obtained in a standard convection oven.

The Convection mode operates with hot circulated air within a temperature range of 85°F to 485°F (29°C to 252°C). For many applications, better results may be achieved with the Combination mode; therefore, the operator may want to consider using the Convection mode on a more limited basis.

### Oven Cool Down Process:

1. Cooking process must be inactive
2. Press **COOL DOWN** button until LED lights (LED remains ON while in **COOL DOWN** mode)
3. Press **Decrease** or **Increase** to adjust cool down temperature
4. Cook temperature display area is used to display cool down temperature
5. Display will show last valid cool down temperature
6. Cool down temperature range is 85°F - 575°F (30°C - 300°C)
7. Press **Start/Stop** until LED lights to accept cool down temperature and initiate cool down process
8. Door must be open to start cool down process; Cook time display area will display "door" if door is not open
9. Cook temperature display area will display set cool down temperature
10. Cook time display area will display current cool down temperature











### Fahrenheit or Celsius Function - choose temperature format:

- Unit is not in a cooking or cleaning process
- Press **Set Oven Temperature**, **Decrease** and **Increase** buttons simultaneously for 1 second
- Cooking temperature display area will display last value "C" or "F"; Display will alternate between "C" and "F" every 2 seconds
- Press **Start/Stop** icon when the display is showing the desired value ("C" or "F")









# SIMPLE CONTROL OPERATING INSTRUCTIONS

## Turn On and Preheat the Oven

Alto-Shaam recommends preheating the CombiTherm® before cooking.







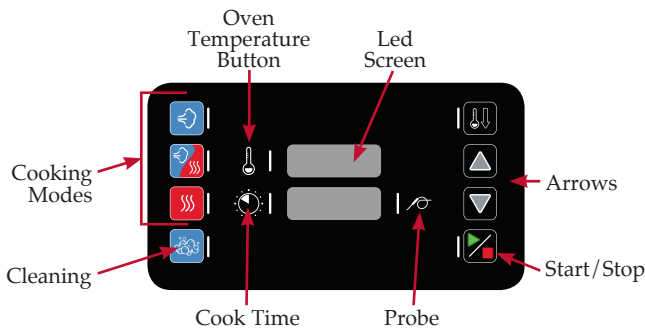

1. Press the **Power** button.  or  Green light will appear while oven is booting up.
2. Choose a **Mode**.  Steam  Combi  Convection
3. Press the **Oven Temperature** button. 
4. Adjust the temperature with arrow buttons. 
5. Press the **Cook Time** button. 
6. Adjust the time with arrow buttons. 
7. Press the **Start/Stop** button. 
8. Preheat the oven before loading food.

## Cooking Manually by Probe



1. Choose a **Mode**.  Steam  Combi  Convection
2. Press the **Oven Temperature** button; adjust the temperature using the arrow buttons.  
3. Press the **Probe Temperature** button; adjust the temperature using the arrow buttons.  
4. Load food into oven and insert probe into food.
5. Press the **Start/Stop** button. 





## Cooking Manually by Time

1. Choose a **Mode**.  Steam  Combi  Convection
2. Press the **Oven Temperature** button; adjust temperature using the arrow buttons.  
3. Press the **Cook Time** button; adjust time using the arrow buttons.  
4. Load food into oven.
5. Press the **Start/Stop** button. 

## Cleaning the Oven

1. Press the **Cleaning** button. 
  2. Insert appropriate number of CombiClean® tabs as directed by the LED Screen (CLn4 appears).
  3. Close the oven door and Press the **Start/Stop** button. 
- If oven is too hot to proceed, **dOOr** will display on the LED screen. Open the oven door to allow the oven to cool. When the oven is finished cooling, begin the cleaning procedure again.
4. Oven beeps when it is done cleaning. Leave door slightly ajar when cleaning is finished.

**NOTE:** to shut the oven off, press and hold  for five seconds. The red light will appear indicating that the oven will begin the shut down process.

To force shut down in the rare event the control locks up, press and hold  for ten seconds.

# CLEANING & MAINTENANCE

## CombiClean® Cleaning Agents



### DANGER

**Rubber gloves must be worn when using CombiClean tablets or spray oven cleaner.**



### DANGER

**Protective eye wear must be worn when using spray oven cleaner.**

**NOTICE:** Use authorized Combitherm cleaner only.

Unauthorized cleaning agents may discolor or harm interior surfaces of the oven. Read and understand label and material safety data sheet before using the oven cleaner.

**CAUTION:** Causes eye, skin, and respiratory tract irritation. Keep out of reach of children.

#### Precautions:

- Do not take internally.
- Avoid contact with eyes and skin.
- Use rubber gloves when using this product.
- Wash hands thoroughly after handling.
- Avoid mixing with strong, concentrated acids.

#### First Aid:

**Skin:** Flush with water. Remove contaminated clothing and do not re-wear until washed. If irritation persists see a physician.

**Eyes:** Flush with water for 15 minutes. See a physician immediately.

**Inhalation:** If difficulty in breathing occurs, leave area immediately and do not return until dust is settled. If irritation persists, see a physician.

**Ingestion:** Drink large quantities of milk or water. *Do not induce vomiting.* See a physician immediately.

**Tablet will begin to dissolve onto skin if handled with damp or wet hands.**

# CLEANING & MAINTENANCE

## Preventative Maintenance

In addition to the routine cleaning and maintenance procedures, there are several additional steps to be taken for both sanitation and to keep the oven running efficiently. These additional safeguards will help prevent down time and costly repairs.

**Do not dispose of grease, fat, wood chips or solid waste down the oven drain.**

Fats and solids will eventually coagulate in the drain system, causing blockage. Consequently, water will back-up into the condenser and interior oven compartment, resulting in an oven that is inoperable.

**Make certain the drain screen is always in place. Remove any solid waste material from the drain screen before it enters the drain system.**

The routine removal of solids from the drain screen will help prevent blockage.

**Use the authorized combitherm oven cleaner only.**

The use of unauthorized cleaning agents may discolor or harm the interior surfaces of the oven.

**To prolong the life of the door gasket, clean this item daily.**

The acids and related compounds found in fat, particularly chicken fat, will weaken the composition of the gasket unless cleaned on a daily basis. Wipe with a hot, soapy cloth.

**To additionally protect gasket life, allow oven door to remain slightly open at the end of the production day.** An open door will relieve the pressure on the door gasket.

**Routinely clean door hinges.**

Open oven door to relieve tension. Clean all parts of the hinge.

**Probe cable placement.**

The probe cable should not be placed near the broiler element at the top of the oven.

**NOTICE:** When smoking is completed, remove smoker box from oven. Dispose of wood chips in a fire proof waste receptacle to prevent the risk of fire.

## DANGER



To prevent serious personal injury, death, or property damage:

**Do not** steam clean, hose down or flood the interior or exterior with water or liquid solution of any kind. **Do not** use water jet to clean. Failure to observe this precaution will void the warranty.

# CLEANING & MAINTENANCE

## CHECKLIST - DAILY

### Unit Information

Business Name: \_\_\_\_\_

Serial Number: \_\_\_\_\_

Model Number: \_\_\_\_\_

Daily Inspection Start Date: \_\_\_\_\_

### Daily Inspection Checklist

	Monday	Tuesday	Wednesday	Thursday	Friday	Saturday	Sunday
Inspect & clean:							
Product probe (thermometer)							
Door gasket (inner door seal)							
Inner Door glass							
Front drip tray							
Touchscreen & overlay (inspect for cracks, peeling, moisture, etc.)							
Execute automatic wash cycle (with approved cleaning chemical ONLY)							
Employee initials							

### Component Failure & Replacement

List details of the failure(s) besides the day they occurred. Leave blank if components are working properly.	
Monday	
Tuesday	
Wednesday	
Thursday	
Friday	
Saturday	
Sunday	

# CLEANING & MAINTENANCE

## CHECKLIST - WEEKLY

### Unit Information

Business Name: \_\_\_\_\_

Serial Number: \_\_\_\_\_

Model Number: \_\_\_\_\_

Daily Inspection Start Date: \_\_\_\_\_

### Weekly Inspection Checklist

Inspect - Oven cavity lamp	
Inspect - Oven cavity for signs of grease/carbon buildup	
Inspect - Behind the fan panel inside the oven cavity for signs of grease/carbon buildup	
Inspect - Behind the fan panel inside the oven cavity for signs of scale buildup	
<b>G</b> Inspect - The heat exchanger for any signs of major deformation. If yes, <i>immediately</i> remove from service and take corrective action steps.	
<b>G</b> Inspect - The heat exchanger for any loose/disconnected pipes or flanges. If yes, <i>immediately</i> remove from service and take corrective action steps.	
<b>E</b> Inspect - Convection elements for signs of cracking, deformation, or damage	
Clean ventless hood grease filters	
Employee initials	

**G** Gas units only

**E** Electric units only

### Component Failure & Replacement

List details of the failure(s) besides the day they occurred. Leave blank if components are working properly.

Week 1	
Week 2	
Week 3	
Week 4	

# CLEANING & MAINTENANCE

## CHECKLIST - MONTHLY

### Unit Information

Business Name: \_\_\_\_\_

Serial Number: \_\_\_\_\_

Model Number: \_\_\_\_\_

Daily Inspection Start Date: \_\_\_\_\_

### Monthly Inspection Checklist

Inspect/Test - Proper draining of the oven cavity	
Inspect - All drain lines for leaks or clogs	
<b>EB</b> Descale the steam generator	
Inspect - Oven cavity for any signs of scale buildup	
Descale the oven interior	
Inspect ventless hood paper filter (replace as needed)	
Test ventless hood drain for proper drainage and signs of leaking	
Employee initials	

**EB** Electric boiler units only

### Component Failure & Replacement

Summarize any component failure(s) that may have occurred during this month.

--



# CLEANING & MAINTENANCE

## CHECKLIST - 12 MONTH

### Unit Information

Business Name: \_\_\_\_\_

Serial Number: \_\_\_\_\_

Model Number: \_\_\_\_\_

Daily Inspection Start Date: \_\_\_\_\_

### 12 Month Inspection Checklist

Replace - Steam bypass hose	
Inspect - Cleaning pump hose	
Inspect/Test - Proper draining of the oven cavity	
Inspect - All drain lines for leaks or clogs	
Inspect - All solenoid hoses (both ends)	
Inspect - Upper browning valve hose	
Inspect - Lower pressure relief valve & hose	
Inspect - Convection element seal (from the electrical compartment)	
Inspect - Gas heat exchanger seal (from the electrical compartment)	
Inspect - N6 oven temperature probe seal	
Descale the steam generator	
Remove & Inspect - Steam generator elements	
Inspect - Hand shower hose	
Inspect - Hand shower handle	
Inspect - Product probe	
Inspect - Water injection tube	
Inspect - Oven cavity for any signs of scale buildup	
Inspect - Oven cavity lamp	
Inspect - Oven cavity for signs of grease/carbon buildup	
Inspect - Behind the fan panel inside the oven cavity for signs of grease/carbon buildup	
Inspect - Behind the fan panel inside the oven cavity for signs of scale buildup	

**EB** Electric boiler units only

**G** Gas units only

**E** Electric units only

# CLEANING & MAINTENANCE

## CHECKLIST - 12 MONTH

### Unit Information

Business Name: \_\_\_\_\_

Serial Number: \_\_\_\_\_

Model Number: \_\_\_\_\_

Daily Inspection Start Date: \_\_\_\_\_

### 12 Month Inspection Checklist

<b>G</b> Inspect - The heat exchanger for any signs of major deformation. If yes, <i>immediately</i> remove from service and take corrective action steps.	
<b>G</b> Inspect - The heat exchanger for any loose/disconnected pipes or flanges. If yes, <i>immediately</i> remove from service and take corrective action steps.	
Inspect & ensure - Exhaust pipes are exiting the oven cavity	
<b>G</b> Inspect - Heat exchanger flange gasket (replace as needed)	
<b>G</b> Inspect & tighten - Heat exchanger burner flange hardware & gasket (replace as needed)	
<b>G</b> Inspect - Heat exchanger igniter flange hardware & gasket (replace as needed)	
<b>G</b> Inspect - Heat exchanger exhaust pipes (ensure they are exiting out past the oven cavity ceiling flange) - ESG models only	
<b>G</b> Inspect - Oven cavity ceiling flange & flange gasket - ESG models only	
<b>G</b> Tighten - Burner flange bolts	
<b>G</b> Tighten - Igniter flange bolts	
Inspect - Heat exchanger weep holes to ensure they are free of obstructions (if the hole is obstructed, immediately remove oven from service and replace the heat exchanger) - Not applicable to CTP/CTC models	
<b>E</b> Inspect - Convection elements for signs of cracking, deformation, or damage	
Replace - Oven lamp cover(s) & gasket(s)	
Descale the oven interior	
Inspect - Door gasket (replace as needed)	
Wipe down the inner door glass	
Inspect - Front drip tray (clean as needed)	
Inspect - Front drip tray hose	
Inspect - Control overlay	
Inspect & tighten - All electrical connections	
Inspect & tighten - All cooling fans for proper operation	

**EB** Electric boiler units only      **G** Gas units only      **E** Electric units only



# CLEANING & MAINTENANCE

## Protecting Stainless Steel Surfaces



It is important to guard against corrosion in the care of stainless steel surfaces. Harsh, corrosive, or inappropriate chemicals can completely destroy the protective surface layer of stainless steel. Abrasive pads, steel wool, or metal implements will abrade surfaces causing damage to this protective coating and will eventually result in areas of corrosion. Even water, particularly hard water that contains high to moderate concentrations of chloride, will cause oxidation and pitting that result in rust and corrosion. In addition, many acidic foods spilled and left to remain on metal surfaces are contributing factors that will corrode surfaces.

Proper cleaning agents, materials, and methods are vital to maintaining the appearance and life of this appliance. Spilled foods should be removed and the area wiped as soon as possible but at the very least, a minimum of once per day. Always thoroughly rinse surfaces after using a cleaning agent and wipe standing water as quickly as possible after rinsing.

## Cleaning Agents

Use non-abrasive cleaning products designed for use on stainless steel surfaces. Cleaning agents must be chloride-free compounds and must not contain quaternary salts. Never use hydrochloric acid (muriatic acid) on stainless steel surfaces. Failure to observe this precaution will void the warranty. Always use the proper cleaning agent at the manufacturer's recommended strength. Contact your local cleaning supplier for product recommendations.

## Cleaning Materials

Cleaning can usually be accomplished with the proper cleaning agent and a soft, clean cloth. When more aggressive methods are needed, use a non-abrasive scouring pad on difficult areas and make certain to scrub with the visible grain of surface metal to avoid surface scratches. Never use wire brushes, metal scouring pads, or scrapers to remove food residue. Failure to observe this precaution will void the warranty.

## CAUTION



To protect stainless steel surfaces, completely avoid the use of abrasive cleaning compounds, chloride based cleaners, or cleaners containing quaternary salts. **NEVER** use hydrochloric acid (muriatic acid) on stainless steel. **NEVER** use wire brushes, metal scouring pads or scrapers.

## WARNING



To prevent **SERIOUS INJURY, DEATH, or PROPERTY DAMAGE:**

The appliance must be cleaned thoroughly to avoid deposits of grease and or food residues inside the appliance that may catch fire. If fat deposits and/or food waste inside the appliance ignite, shut down the appliance immediately and keep the appliance door closed to extinguish the fire. If further extinguishing is required, disconnect the appliance from the main power and use a fire extinguisher (do not use water to extinguish a grease fire!). Failure to clean the appliance properly invalidates the warranty and relieves Alto-Shaam of all liability.

# CLEANING & MAINTENANCE

## Cleaning Schedule

### Daily Gasket Cleaning

It is important to prolong the life of the oven gasket by cleaning on a daily basis. Routine cleaning will help protect the gasket from deterioration caused by acidic foods.

1. Allow the oven to cool, then wipe the gasket and crevices with clean cloth soaked in warm detergent solution.
2. Wipe the gasket and crevices with a cloth and clean rinse water.

Do not attempt to remove gasket or place in the dishwasher.

### Probe Usage And Cleaning

After each use of the **CORE TEMP** mode, wipe the probe tip with a clean paper towel to remove food debris. Follow by wiping the probe with a disposable alcohol pad. Return the probe to the proper door bracket position. The probe cable should not be placed near the broiler element at the top of the oven.

### Probe Cleaning Procedures

1. Remove all food debris from probe between loads and at the end of each production shift. Wipe the entire probe, probe cable assembly, and probe holding bracket with a clean cloth and warm detergent solution.
2. Remove detergent by wiping the probe, cable, and bracket with a cloth and clean rinse water.
3. Wipe probe and probe bracket with disposable alcohol pad or sanitizing solution recommended for food contact surfaces.
4. Allow probe and cable to air dry in the probe holding bracket. The probe cable should not be placed near the broiler element at the top of the oven.
5. Wipe the probe with a disposable alcohol pad prior to inserting into a new food product.

### Daily Oven Cleaning

To be performed at the end of the production day or between production shifts.

### Cleaning Cycle Needed After Smoking

To prevent the transfer of smoke residue to non-smoked products, a cleaning cycle is required before cooking non-smoked items.

### Monthly Cleaning

1. Spray Head
2. Drain Pipe

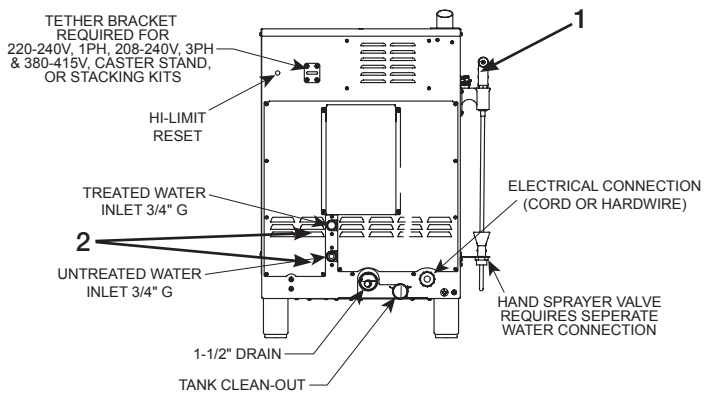

## DANGER



To prevent serious personal injury, death, or property damage:

**Do not** steam clean, hose down or flood the interior or exterior with water or liquid solution of any kind. **Do not** use water jet to clean. Failure to observe this precaution will void the warranty.

# CLEANING & MAINTENANCE

## VENTLESS HOOD MODEL

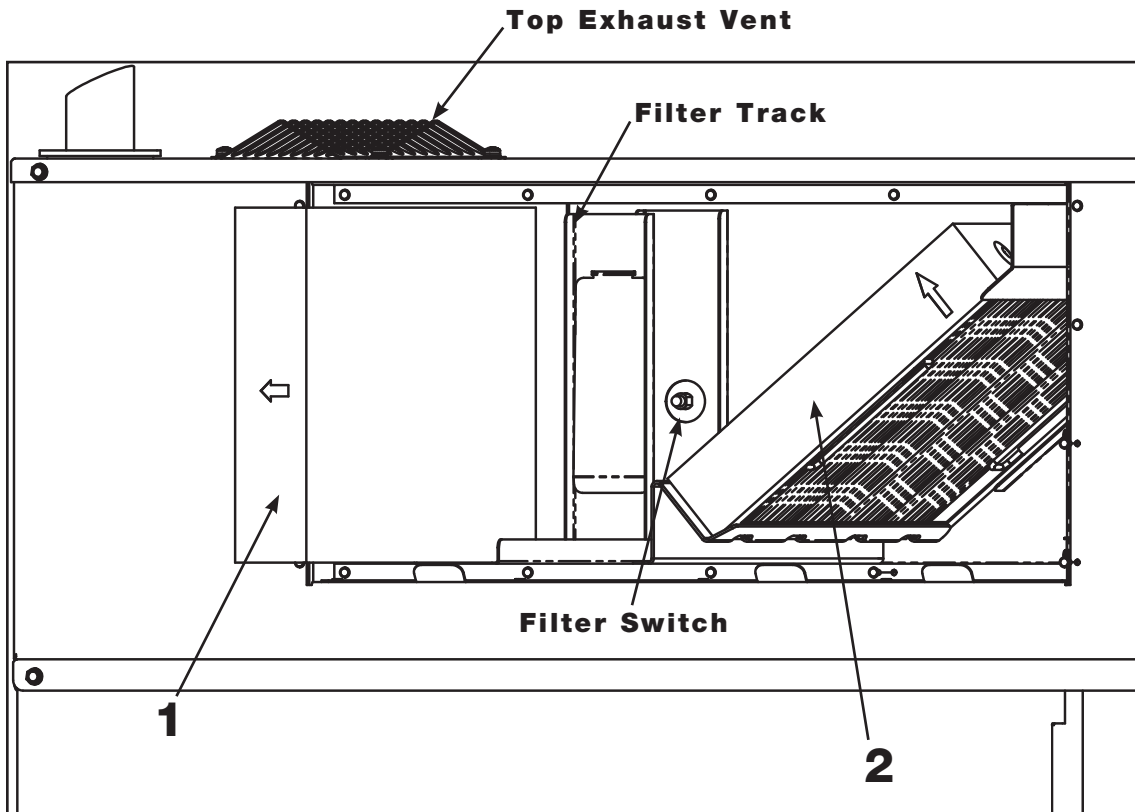

**1. Charcoal Filter:** The charcoal filter should be inspected for contaminant's on a regular basis. Replacement must be made at a minimum of three month intervals — more often if heavy contaminant's are visible or if the filter no longer controls odors.

To remove the charcoal filter, pull and slide out. When replacing the filter, ensure that the filter clip is in place at rear of the filter. Make certain the air flow arrow(s) point toward the hood fan (back of unit), and that the filter is replaced using the filter track in the metal back plate provided with the hood.

FI-24114

**2. Grease Filter:** Cleaning frequency should be based on oven usage with a maximum of two weeks between cleaning if the oven is used for non-grease laden products or steam applications only. Grease laden products require cleaning frequency of at least once a week.

Remove the grease filter by pulling it straight out of the housing. Place the filter in the dishwasher or wash separately by placing in hot, soapy water until all grease and particles have been removed. Rinse thoroughly. Allow the filter to air dry before reinstalling.

To replace the grease filter, the metal handles on the filter casing should be facing toward the front of the unit.

FI-24113

# CLEANING & MAINTENANCE

## ExpressTouch With CombiClean Option

Four (4) cleaning levels are offered: rinse, light, normal, and heavy-duty cleaning. CombiClean® tablets or Combitherm liquid spray cleaner may be used. Side racks and shelves may remain inside oven during cleaning. Remove solid wastes from the bottom of the oven and the drain screen to prevent blockage.

**NOTICE:** If a power outage were to occur during any of the cleaning cycles, the oven will begin a six (6) minute forced-rinse cycle.

1.  Select cleaning mode from any screen.
  - If oven is too hot to safely clean, an oven with red interior will appear on the screen and the cool down function is automatically activated. Allow oven to cool to 200°F (93°C) before cleaning.

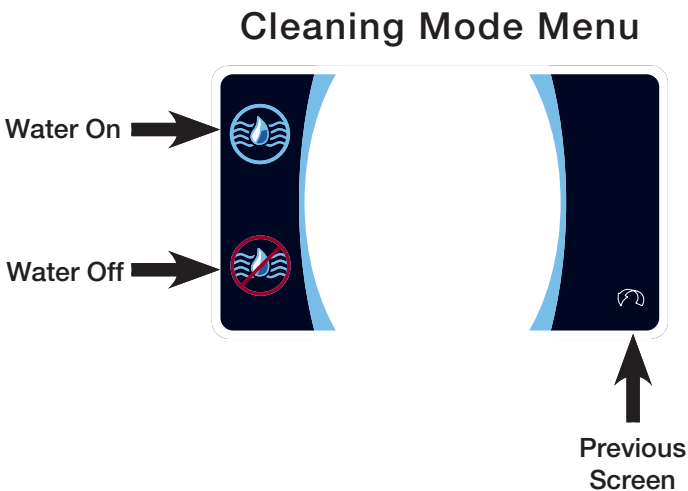

2.  Touch **WATER ON** icon to confirm that water supply is turned on.

## Oven Too Hot Warning

Must allow oven to cool down before inserting CombiClean® tabs or spraying with cleaner

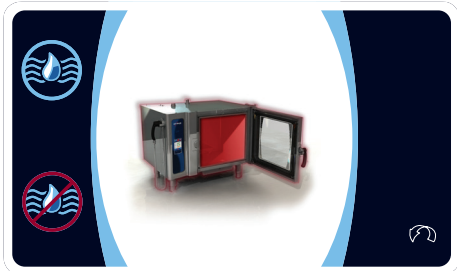

3. Select the desired level of cleaning.

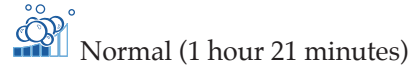

4. Insert the appropriate number of CombiClean® CombiTabs™ as directed by touchscreen or spray interior of oven with combitherm liquid spray cleaner. User may add one additional tablet in either normal or heavy-duty modes for particularly dirty ovens.

## Combi Cleaner Requirement

The number of required CombiClean® tabs is shown.

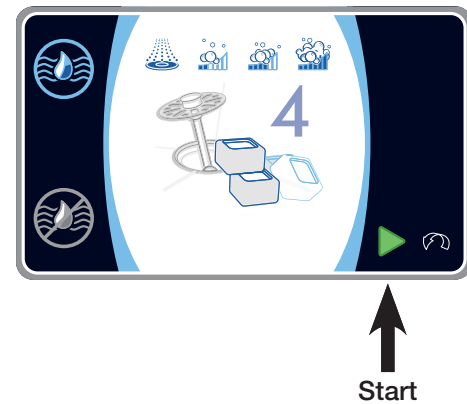

5.  Touch the green **START** arrow icon to begin cleaning. Oven beeps when cleaning is finished. Leave door slightly ajar.

## Cleaning In Progress





# CLEANING & MAINTENANCE

## Simple Control With CombiClean Option

One (1) heavy-duty cleaning cycle (2 hours 5 minutes) is offered. CombiClean® CombiTabs™ or Combitherm liquid spray cleaner may be used. Side racks and shelves may remain inside oven during cleaning. Remove the optional Grill Grate from the appliance interior and wash it separately in hot, soapy water to preserve the special non-stick coating. Remove solid wastes from the bottom of the oven and the drain screen to prevent blockage.

**Notice:** If a power outage were to occur during any portion of the cleaning cycle, the oven will begin a six (6) minute forced-rinse cycle. Cook temperature display area will display "RIN". Cook time display area will display "--"

1.  Select cleaning mode.
  - If the oven is too hot to safely clean, "door" will appear on the screen and the cool down function is automatically activated. Open the oven door to allow oven to cool to 200°F (93°C) before cleaning.

2. Cooking temperature display area will display "CLn". Cooking time display area will display "6" - referring to the number of cleaning tablets to insert.
3. Lift interior oven drain screen and insert three (3) COMBICLEAN® CombiTabs™ or spray interior of oven with Combitherm liquid spray cleaner. User may add one additional tablet for particularly dirty ovens.
4. Close the oven door.
5. Press  button until the LED lights to begin cleaning cycle.
6. Cooking temperature display area displays "CLn".
7. Cooking time display area displays time remaining.
8. The oven beeps when cleaning is finished. Leave the door open approximately 2" (50mm) to allow the oven to air dry.

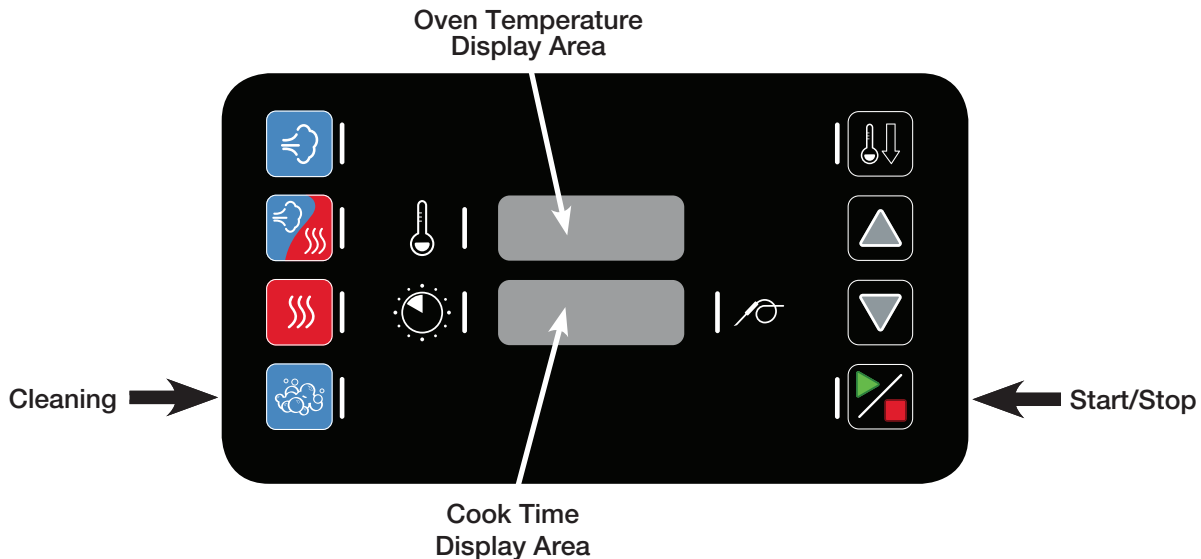



# CLEANING & MAINTENANCE

## Cleaning - **Without** CombiClean Program

The CT Express Combitherm can be ordered without the CombiClean® option. Combitherm liquid spray cleaner should be used.

---



**NOTICE:** If oven is too hot to safely clean, touch the cool down function icon  to activate.

Open the oven door to allow oven to cool to 200°F (93°C) before cleaning.

---

Side racks and shelves may remain inside oven during cleaning. Remove solid wastes from the bottom of the oven and the drain screen to prevent blockage.

Wearing safety glasses and rubber gloves, generously spray the interior oven surfaces with an even coating of Combitherm Liquid Oven Cleaner. Spray all built in components, shelves, and side racks. Spray both sides of the oven.

1. Securely close the oven door and let the solution stand for a minimum of 10 minutes.
2. Press **Power**  on.
3. Press **Steam** .
4. Set **Time**  for ten minutes.
5. Oven beeps for 3 minutes at the end of the steam cycle or until the door is opened or until a cook mode button is pressed.
6. Open door.
7. Make certain to thoroughly rinse all surfaces to remove any cleaning solution residue. Use a non-abrasive cleaning pad for any problem areas.
8. Replace the side racks and shelves.
9. Wipe the door gasket with a hot, soapy cloth.  
Wipe the door gasket again with a clean rinse cloth.
10. Leave the door open approximately 2" (50mm) to allow the oven to air dry.

## DANGER



To prevent serious personal injury, death, or property damage:

**Do not** steam clean, hose down or flood the interior or exterior with water or liquid solution of any kind. **Do not** use water jet to clean. Failure to observe this precaution will void the warranty.

# TROUBLESHOOTING

## Emergency Operation Mode

If the oven malfunctions, an error code will appear in the display. In the event of an error, the Combitherm may be operated on a limited basis. Error conditions under which continued operation is possible are indicated by “Yes” in the chart on the next page. To operate the oven in the event of an error code:

1.  Touch the **Start** icon to acknowledge the error.

The icons that begin to flash represent operational modes that are still usable.

2. Select one of the available cooking modes.

3. Set the oven controls as if operating under normal circumstances.

Depending on the error code involved, oven function, such as temperature range, may be limited.

4.  Touch the **Start** icon to begin cooking.

5.  Touch the **Stop** icon when timer expires.

The Combitherm will return to normal operation when the oven fault is corrected.

# TROUBLESHOOTING

## Emergency Operation Mode (Continued)

### ERROR CODES

When the oven malfunctions, an error code will appear in the display.

 Press the **Start** icon to acknowledge the error.

The icons that begin to flash represent operational modes that are still usable.

When the oven fault is corrected, the Combitherm will return to normal operation.

Error Code	Display Shows	Model		Mode			
		ES	ESG ESI	Steam	Combination	Convection	Retherm
<b>E01</b>	Low Water Boiler	Yes	No	No	No	To 365°F/185°C	No
<b>E02</b>	Control Temp High	Yes	Yes	No	No	No	No
<b>E03</b>	Fan Motor Error	Yes	Yes	No	No	No	No
<b>E04</b>	Fan Motor 2 Error	Yes	Yes	No	No	No	No
<b>E11</b>	Convection Temperature High	Yes	Yes	BOILER UNITS ONLY	No	No	No
<b>E13</b>	Boiler Temperature High	Yes	No	No	No	Yes	No
<b>E15</b>	Condenser Temperature High	Yes	Yes	No	No	To 356°F/180°C	No
<b>E20</b>	B11 Core Temperature Probe Single Point Fault - HACCP only	Yes	Yes	No	No	No	No
<b>E21</b>	N6 Cavity Probe Fault	Yes	Yes	BOILER UNITS ONLY	No	No	No
<b>E22</b>	B10 Core Temp Probe Fault	Yes	Yes	BY TIME ONLY	BY TIME ONLY	BY TIME ONLY	BY TIME ONLY
<b>E23</b>	B4 Boiler Probe Fault	Yes	No	No	No	No	No
<b>E24</b>	B5 Bypass Probe Fault	Yes	Yes	No	No	Yes	No
<b>E25</b>	B3 Condenser Probe Fault	Yes	Yes	Yes	No	To 356°F/180°C	No
<b>E26</b>	N8 Boiler Safety Temperature Probe Fault	Yes	No	No	No	No	No
<b>E27</b>	Boiler Element Temperature High	Yes	No	No	No	Yes	No
<b>E34</b>	Steam Generator Drain Pump Fault	Yes	No	No	No	No	No
<b>E36</b>	Steam Temperature High	Yes	No	No	No	Yes	No
<b>E51</b>	No Water in Boiler	Yes	No	No	No	Yes	No
<b>E53</b>	Fan Motor High Temperature	Yes	Yes	No	No	No	No
<b>E54</b>	Fan Motor 2 High Temperature	Yes	Yes	No	No	No	No
<b>E55</b>	Vent Not Open	Yes	Yes	Yes (NO BROWNING)	Yes (NO BROWNING)	Yes (NO BROWNING)	Yes (NO BROWNING)
<b>E57</b>	No Rinse Water	Yes	Yes	Yes	Yes	Yes	Yes
<b>E93</b>	Communication Error FROM Display Board	Yes	Yes	No	No	No	No
<b>E94</b>	Communication Error TO Display Board	Yes	Yes	No	No	No	No

# TROUBLESHOOTING

## ERROR CODES

If your Alto-Shaam® unit is not operating properly, check the following before calling your Authorized Alto-Shaam Service Agent:

- ☛ Check that unit is receiving power. Circuit breaker turned on?

## NOTICE

This section is provided for the assistance of qualified and trained service technicians only and is not intended for use by untrained or unauthorized service personnel. Do not attempt to repair or service the oven beyond this point. Contact Alto-Shaam for the nearest authorized service agent. Repairs made by any other service agents without prior authorization by Alto-Shaam will void the warranty.

When the oven malfunctions, an error code will appear in the display.

 Press the **Start** icon to acknowledge the error.

When the oven error notification has been acknowledged, the Combitherm will attempt to return to normal operation.

Error Code	Error Call Out in Display	Description of Error	Possible Causes
<b>E01</b>	Low Water Boiler	Low water level in boiler	<ul style="list-style-type: none"> <li>— Water supply is shut off.</li> <li>— Low water pressure.</li> <li>— Generator drain cap/hose missing or leaking.</li> <li>— Generator drain pump is defective.</li> <li>— Generator drain pump elbow leaking.</li> <li>— Fill solenoid not energized.</li> <li>— Fill solenoid faulty.</li> <li>— Wiring or connection error at the solenoid or the relay board.</li> <li>— Water level probe connection/wiring error at probe or relay board.</li> <li>— Water level probe requires descaling and/or replacement.</li> </ul>
<b>E02</b>	Control Temperature High	Relay board surface temperature too high	<ul style="list-style-type: none"> <li>— Cooling fan(s) not being energized.</li> <li>— Cooling fan(s) faulty.</li> <li>— Wiring/connection error at cooling fan(s).</li> <li>— Faulty relay board.</li> </ul>
<b>E03</b>	Convection Fan Motor Error	Convection fan motor failure	<ul style="list-style-type: none"> <li>— Motor VFD not energized.</li> <li>— No input signal to VFD from relay board.</li> <li>— Motor VFD faulty, not outputting to motor after input signal received.</li> <li>— Motor fan wheel blocked/obstructed.</li> <li>— Connection/wiring error at VFD, motor, hall effect sensor, relay board.</li> <li>— Faulty motor.</li> </ul>
<b>E04</b>	Lower Convection Fan Motor Error	Lower convection fan motor failure on 20-20 unit	<ul style="list-style-type: none"> <li>— Motor VFD not energized.</li> <li>— No input signal to VFD from relay board.</li> <li>— Motor VFD faulty, not outputting to motor after input signal received.</li> <li>— Motor fan wheel blocked/obstructed.</li> <li>— Connection/wiring error at VFD, motor, hall effect sensor, relay board.</li> <li>— Faulty motor.</li> </ul>

(CONTINUED ON NEXT PAGE)

# TROUBLESHOOTING

## ERROR CODES

Error Code	Error Call Out in Display	Description of Error	Possible Causes
<b>E11</b>	Convection Temperature High	Oven cavity temperature N6 too high	<ul style="list-style-type: none"> <li>— Convection element contactor stuck closed/on.</li> <li>— Faulty oven temperature probe connection at relay board.</li> <li>— Faulty N6 oven temperature probe.</li> <li>— Faulty relay board.</li> </ul>
<b>E13</b>	Boiler Temperature High	Steam generator temperature too hot	<ul style="list-style-type: none"> <li>— Immersion element is not submersed in water due to scale build up on the water level probe/ inside the tank.</li> <li>— Immersion element contactor stuck closed.</li> <li>— Faulty B4 steam generator temperature probe connection at relay board.</li> <li>— Faulty B4 temperature probe.</li> </ul>
<b>E15</b>	Condensor Temperature High	Condensor water temperature too high	<ul style="list-style-type: none"> <li>— Untreated water supply line is disconnected or shut off.</li> <li>— Cooling solenoid is not being energized when B3 probe is above set point.</li> <li>— Faulty B3 condensate temperature probe connection at relay board.</li> <li>— Faulty B3 condensate temperature probe.</li> </ul>
<b>E20</b>	<p>HACCP Only - B11 Core Temperature Probe Single Point Fault</p> <p>Error E20 is not shown in display. Instead a probe sign with “?” is shown as popup window. In case the customer cooks in time mode during first step and during second step switches to probe mode but has no probe in place, the error E20 will be shown in the error code list and HACCP list.</p>	Single point core temperature probe defect or disconnected	<ul style="list-style-type: none"> <li>— Probe not installed inside oven.</li> <li>— Faulty B11 Single Point Core Temperature probe receptacle connection at relay board.</li> <li>— Faulty B11 single point core temperature probe.</li> <li>— Debris buildup on probe receptacle pins inside of the oven.</li> </ul>
<b>E21</b>	N6 Oven Cavity Temperature Probe Fault	N6 probe “open”	<ul style="list-style-type: none"> <li>— Faulty N6 oven cavity temperature probe connection at relay board.</li> <li>— Faulty N6 oven temperature probe.</li> </ul>
<b>E22</b>	B10 Core Temperature Probe Multipoint Fault	Multipoint core temperature probe defect or disconnected	<ul style="list-style-type: none"> <li>— Faulty B10 multipoint core temperature probe connection at relay board.</li> <li>— Faulty B10 multipoint core temperature probe.</li> </ul>
<b>E23</b>	B4 Boiler Probe Fault	B4 probe “open”	<ul style="list-style-type: none"> <li>— Faulty B4 boiler temperature probe connection at relay board.</li> <li>— Faulty B4 boiler temperature probe.</li> </ul>
<b>E24</b>	B5 Bypass Probe Fault	B5 probe “open”	<ul style="list-style-type: none"> <li>— Faulty B5 steam bypass probe connection at relay board.</li> <li>— Faulty B5 steam bypass probe.</li> </ul>
<b>E25</b>	B3 Condensor Probe Fault	B3 probe “open”	<ul style="list-style-type: none"> <li>— Faulty B3 condensor probe connection at relay board.</li> <li>— Faulty B3 condensor probe.</li> </ul>
<b>E26</b>	N8 Immersion Element Safety Probe Fault	N8 probe “open”	<ul style="list-style-type: none"> <li>— Faulty N8 safety temperature probe connection at relay board.</li> <li>— Faulty N8 safety temperature probe.</li> </ul>

(CONTINUED ON NEXT PAGE)

# TROUBLESHOOTING

## ERROR CODES

Error Code	Error Call Out in Display	Description of Error	Possible Causes
<b>E27</b>	N8 Immersion Element Temperature Too High	Immersion element too hot	<ul style="list-style-type: none"> <li>— Scale buildup inside steam generator and/or on water level probe.</li> <li>— Immersion element contactor stuck closed.</li> <li>— Faulty N8 safety temperature probe.</li> </ul>
<b>E34</b>	Steam Generator Drain Pump Fault	Water level in steam generator does not drop during cleaning program	<ul style="list-style-type: none"> <li>— Scale buildup inside the steam generator and/or water level probe.</li> <li>— Obstruction on inlet side of steam generator drain pump.</li> <li>— Boiler steam generator pump not being energized.</li> <li>— Steam generator drain pump defective.</li> </ul>
<b>E36</b>	Steam Temperature High	Oven cavity temperature is too high when operating in steam mode or combination mode	<ul style="list-style-type: none"> <li>— Water supply is not connected or shut off.</li> <li>— Low water pressure.</li> <li>— Y1 solenoid valve not energized on a call for steam.</li> <li>— Y1 solenoid faulty.</li> <li>— Flow restrictor obstructed.</li> <li>— Water injection pipe obstructed.</li> <li>— Steam bypass hose obstructed.</li> <li>— B5 steam bypass probe dirty or faulty.</li> </ul>
<b>E51</b>	No Water In Boiler	Steam generator fill error	<ul style="list-style-type: none"> <li>— Water supply is disconnected or shut off.</li> <li>— Low water pressure.</li> <li>— Boiler drain cap leaking or missing.</li> <li>— Boiler drain pump defective.</li> <li>— Drain pump elbow leaking.</li> <li>— Fill solenoid not energized.</li> <li>— Fill solenoid faulty.</li> <li>— Connection/wiring error at the solenoid or the relay board.</li> <li>— Water level probe connection/wiring error at probe or the relay board.</li> <li>— Water level probe requires descaling and/or replacement.</li> </ul>
<b>E53</b>	Fan Motor High Temperature	Fan motor high limit	<ul style="list-style-type: none"> <li>— Faulty motor high limit connection at relay board.</li> <li>— Obstructed fan wheel.</li> <li>— Faulty convection motor.</li> </ul>
<b>E54</b>	Lower Fan Motor High Temperature (20-20 unit size only)	Fan motor high limit	<ul style="list-style-type: none"> <li>— Faulty motor high limit connection at relay board.</li> <li>— Obstructed fan wheel.</li> <li>— Faulty convection motor.</li> </ul>
<b>E55</b>	Vent Not Open	Browning valve does not open	<ul style="list-style-type: none"> <li>— Browning valve vent motor not being energized.</li> <li>— Alignment issue between motor cam and vent motor safety switch (micro switch).</li> <li>— Faulty connection at vent motor, vent motor switch or relay board.</li> <li>— Fault vent valve safety switch (micro switch).</li> <li>— Faulty vent motor.</li> </ul>

(CONTINUED ON NEXT PAGE)

# TROUBLESHOOTING

## ERROR CODES

<b>Error Code</b>	<b>Error Call Out in Display</b>	<b>Description of Error</b>	<b>Possible Causes</b>
<b>E57</b>	No Rinse Water	During rinse no water flow is detected through solenoid valve	<ul style="list-style-type: none"> <li>— Water supply is shut off.</li> <li>— Low water pressure.</li> <li>— Check wiring to all components mentioned below.</li> <li>— Flow switch is dirty or defective.</li> <li>— Double water solenoid valve defective (Y3.)</li> <li>— Relay board, high voltage, defective.</li> </ul>
<b>E92</b>	Communication Error, RB Does Not Properly Respond	Communication error between display board and relay board	<ul style="list-style-type: none"> <li>— Faulty ribbon cable connections between boards.</li> <li>— Faulty ribbon cable.</li> <li>— Relay board, low voltage, connector defective.</li> <li>— Display board connector defective.</li> </ul>
<b>E93</b>	Communication Error, FROM Display Board	Communication error between display board and low voltage relay board	<ul style="list-style-type: none"> <li>— Faulty ribbon cable connections between boards.</li> <li>— Faulty ribbon cable.</li> <li>— Relay board, low voltage, connector defective.</li> <li>— Display board connector defective.</li> </ul>
<b>E94</b>	Communication Error, TO Display Board	Communication error between display board and low voltage relay board	<ul style="list-style-type: none"> <li>— Faulty ribbon cable connections between boards.</li> <li>— Faulty ribbon cable.</li> <li>— Relay board, low voltage, connector defective.</li> <li>— Display board connector defective.</li> </ul>
<b>E98</b>	RB is in Celsius and DB is in Fahrenheit	Change the unit configuration in the setup menu	<ul style="list-style-type: none"> <li>— Control programming issue.</li> <li>— Ribbon cable defective.</li> <li>— Relay board, low voltage, connector defective.</li> <li>— Display board connector defective.</li> </ul>
<b>E99</b>	RB is in Fahrenheit and DB is in Celsius	Change the unit configuration in the setup menu	<ul style="list-style-type: none"> <li>— Control programming issue.</li> <li>— Ribbon cable defective.</li> <li>— Relay board, low voltage, connector defective.</li> <li>— Display board connector defective.</li> </ul>
<b>E100</b>	DB version is not equal to RB version. Error generated by DB.	Software update may have failed.	<ul style="list-style-type: none"> <li>— Perform software update.</li> <li>— Ribbon cable defective.</li> <li>— Faulty compact flash card.</li> <li>— Relay board, low voltage, connector defective.</li> <li>— Display board connector defective.</li> <li>— Software may need to be updated again.</li> </ul>

# TROUBLESHOOTING

## ERROR CODES

<b>Error Code</b>	<b>Error Call Out in Display</b>	<b>Description of Error</b>	<b>Possible Causes</b>
<b>E101</b>	DB version is not equal to RB version. Error generated by RB.	Software update may have failed.	<ul style="list-style-type: none"> <li>— Perform software update.</li> <li>— Ribbon cable defective.</li> <li>— Faulty compact flash card.</li> <li>— Relay board, low voltage, connector defective.</li> <li>— Display board connector defective.</li> <li>— Software may need to be updated again.</li> </ul>
<b>E102</b>	Ventless Hood Fault — Filters Not Present	Filter safety switches are not properly activated.	<ul style="list-style-type: none"> <li>— Grease and/or charcoal filter not installed.</li> <li>— Faulty filter switch.</li> <li>— Poor connection at safety switch or relay board.</li> </ul>
<b>E103</b>	Ventless Hood Fault — Pressure Failure	Ventless hood operation failure.	<ul style="list-style-type: none"> <li>— Hood power switch not turned to the on position.</li> <li>— Hood power switch defective.</li> <li>— Hood fan not operating.</li> <li>— Filter(s) clogged/need replacement.</li> <li>— Pressure switch tube plugged or disconnected.</li> <li>— Faulty pressure switch or connection error/failure.</li> <li>— Hood fan turning in the wrong direction.</li> </ul>
<b>E104</b>	Ignition Failure	Attempt for ignition.	<ul style="list-style-type: none"> <li>— Gas supply disconnected or turned off.</li> <li>— Gas supply pressure too low/too high.</li> <li>— Gas valve not being energized by ignition control.</li> <li>— Ignition control not creating a spark.</li> <li>— Faulty spark wire and/or igniter.</li> <li>— Faulty flame sense wire or sensing wire connection.</li> <li>— Faulty ignition control.</li> <li>— Blocked or obstructed flue pipe(s).</li> </ul>
<b>E105</b>	Low Water Pressure	Low or no water pressure to oven.	<ul style="list-style-type: none"> <li>— Water supply not connected or turned off.</li> <li>— Water pressure too low.</li> <li>— Solenoid valve not being energized.</li> <li>— Solenoid valve not opening.</li> <li>— Pressure switch faulty.</li> <li>— Poor connection at pressure switch and/or relay board.</li> </ul>
<b>E106</b>	Cleaning Pump Fault	Cleaning pump is not running.	<ul style="list-style-type: none"> <li>— Cleaning pump motor not being energized.</li> <li>— Cleaning pump faulty.</li> <li>— Poor connection at pump motor and/or relay board.</li> <li>— Hall effect sensor wiring/connection error/failure.</li> </ul>
<b>E107</b>	Boiler Drain Pump Fault	Boiler drain pump is not running.	<ul style="list-style-type: none"> <li>— Boiler drain pump motor not being energized.</li> <li>— Boiler drain pump faulty.</li> <li>— Poor connection at pump motor and/or relay board.</li> <li>— Hall effect sensor wiring/connection error/failure.</li> </ul>