



Simplicity and agility
for large quantities
and intensive use.



Find out more!



Access the website



Sales brochure

Hood-type dishwashers

Advance	367
Concept +	369
Concept.....	370
Accessories	374

Water connection:
It is advisable to introduce sanitary water in the dishwashers, with a temperature of 50 - 60 °C.

Water pressure:
Minimum: 2 bar = 2 kg/cm²
Maximum: 4 bar = 4 kg/cm²

Water softener:
All glass / dishwashers should be connected to a treated water supply when the local supply is over 10 HF / 6 HD.



Any issues derived from a bad installation that don't meet with the indicated conditions will not be considered as a warranty.

Hood-type | Advance



General characteristics

- Model with electronic and digital control.
- Digital display with information on programs, times and temperatures.
- Electronic programmer with help system for technical service.
- Rinse pump which guarantees a perfect hygiene result with complete linear rinse cycle at 85°C. (EFFIRINSE) de acuerdo con las especificaciones de seguridad e higiene de la norma DIN10512.
- 55s, 75s, 120s, 480s and 'Glass' wash cycles.
- Theoretical maximum production of 65 baskets/hour (1170 plates/h).
- Program for tank emptying cycle.
- Double-walled Hood with special compressed insulating material.
- Tank with volume of 28 litres, with 2.1 kW heating element.
- Boiler with volume of 9 litres, with 9 kW heating element.
- Simultaneous tank and boiler heating.
- Maximum Total power: 11.85 kW (simultaneous).
- Drainage pump - power 70 W - tank emptying program.
- Rinse aid doser incorporated.
- Rinse aid doser incorporated.
- IPX5 anti-humidity protection.

	MODEL	"CODE 50 HZ."	"CODE 60 HZ."	€	
CHARACTERISTICS					
 Basic model	AD-125	19073921	19075047	-	
Rinse pump	A	A			
Drainage pump	B	B			
Peristaltic detergent doser	DD	DD			
Voltage		MULTIVOLTAGE			
Power	(kW)	MULTIPOWER			
Dimensions	(mm)	630 x 750 x 1.465			
VERSIONS					
 Descaling system and tank with regeneration program	SOFT	AD-125 SOFT	19075295	19075298	-
CHARACTERISTICS					
Model with recovery system	AD-125 HRS	19075296	19075299	-	
Heat recovery system	HRS	HRS			
Dimensions	(mm)	630 x 750 x 1.990			
VERSIONS					
 Descaling system and tank with regeneration program and detergent dispenser	SOFT	AD-125 SOFT HRS	19074195	19075048	-
* Consult other possible factory versions.					
ACCESORIES					
Entry-exit tables	see page 374				
Conversion kits	see page 376				
Water softeners	see page 410				
Osmosis	see page 410				
Baskets	see page 411				

Hood-type | Advance



General characteristics

- Model with electronic and digital control.
- Digital display with information on programs, times and temperatures.
- Electronic programmer with help system for technical service.
- Rinse pump which guarantees a perfect hygiene result with complete linear rinse cycle at 85°C. (EFFIRINSE) de acuerdo con las especificaciones de seguridad e higiene de la norma DIN10512.
- 55s, 75s, 120s and 480s wash cycles.
- Double-walled Hood with special compressed insulating material.
- Tank with volume of 28 litres, with 2.1 kW heating element.
- The ECO version Hood-Type dishwashers are fitted with an external hot water generator, gas heated, model GWB-20.
- The generator replaces the electric rinse boiler in the dishwasher, bringing a significant saving in electricity consumption.

	MODEL	*CODE 50 HZ.*	*CODE 60 HZ.*	€
CHARACTERISTICS				
Basic model	AD-125 ECO	19075300	19075301	-
Rinse pump	A	A		
Drainage pump	B	B		
Peristaltic detergent doser	DD	DD		
Voltage	MULTIVOLTAGE			
Power	(kW)	2,70		
Dimensions	(mm)	630 x 750 x 1.465		

(1) Note on codes

When placing your order, to the machine code, please add the generator code GWB-20 (according to the type of gas and electrical frequency), included in the price.

Gas hot water generator GWB-20

Forced draught burner and double safety valve. Electronic control of temperature and water levels. Automatic limescale removal. Automatic tank emptying.

	MODEL	*CODE 50 HZ.*	*CODE 60 HZ.*	€	
Power	(kW)	20			
Dimensions	(mm)	432x548x770			
Butane/propane gas	LPG	GWB-20 LPG	19010831	19044806	-
Natural gas	GN	GWB-20 GN	19038551	19044807	-



Accessories supplied: One CT-10 base basket, 1 CP-16/18 basket for plates and two cutlery holders.

Hood-type | Concept+



General characteristics

- Model with electronic control and display of temperature, functions and errors.
- Control with help system for technical service.
- Thermostop system with rinse pump that guarantees a perfect hygienic result with a complete rinse at 80–85 °C (EFFIRINSE) in accordance with the safety and hygiene specifications of standard DIN10512..
- Air Brake check valve system type AA according to EN 1717/WRAS.
- 55s, 75s, 120s and 600s wash cycles.
- Theoretical maximum production of 65 baskets/hour (1170 plates/h).
- Tank with volume of 33 litres, with 4.5 kW heating element.
- Boiler with volume of 9 litres, with 9 kW heating element.
- Alternating or simultaneous tank and boiler heating.
- Maximum Total power: 9.75 kW (alternating) or 14.75 kW (simultaneous).
- IPX4 anti-humidity protection.

	MODEL	*CÓDIGO 50 HZ.*	*CÓDIGO 60 HZ.*	€		
CHARACTERISTICS						
	Basic model	COP-144	19073920	19075045	-	
	Rinse pump	A	A			
	Voltage	MULTIVOLTAGE				
	Power	(kW)	9,75 / 14,25			
	Dimensions	(mm)	630 x 750 x 1.465			
VERSIONS						
	Drainage pump	B	COP-144 B	19075288	19075292	-
	Peristaltic detergent doser	DD	COP-144 DD	19075289	19075293	-
	Drainage pump and detergent doser	B - DD	COP-144 B DD	19075290	19075294	-
	CHARACTERISTICS					
	Model with recovery system	COP-144 HRS	19075044	19075046	-	
	Heat recovery system	HRS	HRS			
	Dimensions	(mm)	630 x 750 x 1.990			
VERSIONS						
	Drainage pump and detergent doser	B - dd	COP-144 HRS B DD	19075291	19081123	-

* Consult other possible factory versions.

ACCESORIES	
Entry-exit tables	see page 374
Conversion kits	see page 376
Water softeners	see page 410
Osmosis	see page 410
Baskets	see page 411



Accessories supplied: One CT-10 base basket, 1 CP-16/18 basket for plates and two cutlery holders.

Hood-type | Concept



General characteristics

- Model with electronic control and display of temperature, functions and errors.
- 55s, 75s, 120s and 600s wash cycles.
- Theoretical maximum production of 65 baskets/hour (1170 plates/h).
- Tank with volume of 33 litres, with 4.5 kW heating element.
- Boiler with volume of 9 litres, with 9 kW heating element.
- Alternating or simultaneous tank and boiler heating.
- Thermal stop system which guarantees a rinse temperature of 85°C. Standard factory setting disabled.
- Maximum Total power: 9.75 kW (alternating) or 14.75 kW (simultaneous).
- IPX4 anti-humidity protection.

		MODEL	"CODE 50 HZ."	"CODE 60 HZ."	€	
CHARACTERISTICS						
	Basic model	CO-142	19073919	19075042	-	
	Voltage	MULTIVOLTAGE				
	Power (kW)	9,75 / 14,25				
	Dimensions (mm)	630 x 750 x 1.465				
VERSIONS						
	Drainage pump	B	CO-142 B	19075277	19075285	-
	Peristaltic detergent doser	DD	CO-142 DD	19075278	19075286	-
	Drainage pump and detergent doser	B - DD	CO-142 B DD	19075279	19075287	-
CHARACTERISTICS						
	Model with recovery system	CO-142 HRS	19075041	19075043	-	
	Heat recovery system	HRS	HRS			
	Dimensions (mm)	630 x 750 x 1.990				
VERSIONS						
	Drainage pump and detergent doser	B - DD	CO-142 HRS B DD	19075282	19081120	-

* Consult other possible factory versions.

ACCESSORIES	
Entry-exit tables	see page. 374
Conversion kits	see page. 376
Water softeners	see page. 410
Baskets	see page. 411



Accessories supplied: One CT-10 base basket, 1 CP-16/18 basket for plates and two cutlery holders.

Hood-type | Concept



General characteristics

- Model with highly resistant control buttons.
- 90s, 120s, 180s and 600s wash cycles.
- Theoretical maximum production of 40 baskets/hour.
- Tank with volume of 33 litres, with 4.5 kW heating element.
- Boiler with volume of 9 litres, with 6 kW heating element.
- Alternating or simultaneous tank and boiler heating.
- Thermal stop system which guarantees a rinse temperature of 85°C. Standard factory setting disabled.
- Maximum Total power: 6.75 kW (alternating) or 11.25 kW (simultaneous).
- IPX4 anti-humidity protection.

		MODEL	"CODE 50 HZ."	"CODE 60 HZ."	€	
CHARACTERISTICS						
	Basic model	CO-110	19073548	19075029	-	
	Voltage	MULTIVOLTAGE				
	Power (kW)	6,75 / 11,25				
	Dimensions (mm)	630 x 750 x 1.465				
VERSIONS						
	Drainage pump	B	CO-110 B	19075270	19075274	-
	Peristaltic detergent doser	DD	CO-110 DD	19075271	19075275	-
	Drainage pump and detergent doser	B - DD	CO-110 B DD	19075272	19075276	-
	CHARACTERISTICS					
	Model with recovery system	CO-110 HRS	19075016	19075040	-	
	Heat recovery system	HRS	HRS			
	Dimensions (mm)	630 x 750 x 1.990				
VERSIONS						
	Drainage pump and detergent doser	B - DD	CO-110 HRS B DD	19075273	19081101	-

* Consult other possible factory versions.

ACCESORIES	
Entry-exit tables	see page 374
Conversion kits	see page 376
Water softeners	see page 410
Baskets	see page 411

Accessories supplied: One CT-10 base basket, 1 CP-16/18 basket for plates and two cutlery holders.

Foodservice | Dishwashing

		ADVANCE		CONCEPT +		CONCEPT
TECHNICAL DATA		AD-125	AD-125 eco	COP-144	CO-142	CO-110
WASH CYCLES						
Cycle Time	[s]	55/75/120/480	55/75/120/480	55/75/120/600	55/75/120/600	90/120/180/600
THEORETICAL CAPACITY*1						
Baskets	[cestas/h]	65	65	65	65	40
Plates	[platos/h]	1170	1170	1170	1170	720
Glasses	[vasos/h]	2340	2340	2340	2340	1440
WATER CONSUMPTION						
Tank capacity	[l]	28	28	33	33	33
Boiler capacity		10	13	10	9	9
Rinse water consumption per cycle *2	[l]	2.4	2.4	2.4	2.4	2.4
TEMPERATURES						
Tank temperature	[°C]	60 (55-71)	60 (55-71)	60	60	60
Rinse water temperature	[°C]	82 (65-85)	82 (65-85)	85	85	85
DIMENSIONS						
Width	[mm]	712	712	712	712	712
Depth	[mm]	750 (827)	750 (827)	750 (827)	750 (827)	750 (827)
Height with hood closed *3	[mm]	1465	1465	1465	1465	1465
Height with hood open	[mm]	1940	1940	1940	1940	1940
Height with HRS	[mm]	1990	1990	1990	1990	1990
Operating height	[mm]	820-890	820-890	820-890	820-890	820-890
Useful height	[mm]	430	430	430	430	430
Basket size	[mm]	500x500	500x500	500x500	500x500	500x500
ELECTRICAL SPECIFICATIONS						
Total power connected(Alt/Sim)	[kW]	Ver tabla	Ver tabla	Ver tabla	Ver tabla	Ver tabla
Fuse protection	[A]	Ver tabla	Ver tabla	Ver tabla	Ver tabla	Ver tabla
Wash pump (P1)	[kW]	0.75	0.75	0.75	0.75	0.75
Tank power	[kW]	2.1	2.1	4.5	4.5	4.5
Rinse pump	[kW]	0.25	0.25	0.25	-	-
Boiler power	[kW]	9	-	9	9	6
Connection (factory default)		400V/50Hz/3N~	400V/50Hz/3N~	400V/50Hz/3N~	400V/50Hz/3N~	400V/50Hz/3N~
OTHER INFORMATION						
Min. inlet temperature	[°C]	15	15	15	15	15
Max. inlet temperature	[°C]	60	60	60	60	60
Grid pressure	[bar/kPA]	1.0-4.0/100-400	1.0-4.0/100-400	1.0-4.0/100-400	2.0-4.0/200-400	2.0-4.0/200-400
Grid pressure requerida para HRS	[bar/kPA]	2.0-4.0/200-400	2.0-4.0/200-400	2.0-4.0/200-400	2.0-4.0/200-400	2.0-4.0/200-400
Max. drain height (only B models)	[mm]	600	600	130/600(B)	130/600(B)	130/600(B)
Noise level (dBA)	[dBA]	<65	<65	<70	<70	<70
Moisture protection		IPX5	IPX5	IPX4	IPX4	IPX4
Net/gross weight	[kg]	111/129	109/127	97/115	95/113	95/113
Net/gross weight with HRS	[kg]	127/147	125/145	113/133	111/131	111/131
Spray Arms		sst	sst	sst	sst	sst
ACCESSORIES						
Glasses basket	[un]	1	1	1	1	1
Small cutlery basket	[un]	2	2	2	2	2
Baskets for plates	[un]	1	1	1	1	1

* 1 Customer circumstances (inlet water temperature/electrical connection) may reduce the values indicated here.

* 2 Non-binding information. The actual rinse water requirements may vary depending on site conditions.

* 3 The adjustable feet allow the vertical dimensions to be raised as required up to 25 mm.

* 4 4 Models with energy recovery (HRS): Total kW + 0.5 kW & Total Amp.+ 0.4 A.

	VOLTAGE	FACTORY DEFAULT	FUSE PROTECTION	TOTAL AMP.	TOTAL CONNECTED LOAD	CONNECTION	TANK POWER	BOILERPOWER	WASH PUMP POWER
AD-125	380 V - 415 V / 3N~	FD	20 A	18.7 A	11,85 kW	SIM	2.1 kW	9 kW	0.75 kW
	220 V - 240 V / 1N~		32 A	26.7 A	6,35 kW	SIM	1.1 kW	4.5 kW	0.75 kW
	220 V - 240 V / 1N~		40 A	34.8 A	8,15 kW	SIM	1.4 kW	6 kW	0.75 kW
	230 V / 3~		40 A	30,5 A	11,85 kW	SIM	2.1 kW	9 kW	0.75 kW
AD-125 eco	380 V - 415 V / 3N~	FD	16 A	5.7 A	2,85 kW	-	2.1 kW	-	0.75 kW
	220 V - 240 V / 1N~		16 A	11.8 A	2,85 kW	-	2.1 kW	-	0.75 kW
	230 V / 3~		16 A	7.9 A	2,85 kW	-	2.1 kW	-	0.75 kW
"COP-144 CO-142"	380 V - 415 V / 3N~		20 A	15.7 A	9,75 kW	ALT	4.5 Kw	9 kW	0.75 kW
	380 V - 415 V / 3N~	FD	25 A	22.2 A	14,25 kW	SIM	4.5 Kw	9 kW	0.75 kW
	220 V - 240 V / 1N~		25 A	22.2 A	5,25 kW	ALT	2.3 Kw	4.5 kW	0.75 kW
	220 V - 240 V / 1N~		32 A	28.7 A	6,75 kW	ALT	3 Kw	6 kW	0.75 kW
	220 V - 240 V / 1N~		50 A	41.8 A	9,75 kW	ALT	4.5 Kw	9 kW	0.75 kW
	220 V - 240 V / 1N~		40 A	32 A	7,55 kW	SIM	2.3 Kw	4.5 kW	0.75 kW
	220 V - 240 V / 1N~		50 A	41.8 A	9,75 kW	SIM	3 Kw	6 kW	0.75 kW
	230 V / 3~		32 A	25.2 A	9,75 kW	ALT	4.5 Kw	9 kW	0.75 kW
CO-110	230 V / 3~		40 A	36.5 A	14,25 kW	SIM	4.5 Kw	9 kW	0.75 kW
	380 V - 415 V / 3N~		16 A	11.3 A	6,75 kW	ALT	4.5 Kw	6 kW	0.75 kW
	380 V - 415 V / 3N~	FD	20 A	17.8 A	11,25 kW	SIM	4.5 Kw	6 kW	0.75 kW
	220 V - 240 V / 1N~		20 A	15.7 A	3,75 kW	ALT	2.25 Kw	3 kW	0.75 kW
	220 V - 240 V / 1N~		25 A	20 A	4,75 kW	ALT	3 Kw	4 kW	0.75 kW
	220 V - 240 V / 1N~		32 A	28.7 A	6,75 kW	ALT	4.5 Kw	6 kW	0.75 kW
	220 V - 240 V / 1N~		32 A	25.7 A	6,05 kW	SIM	2.25 Kw	3 kW	0.75 kW
	220 V - 240 V / 1N~		40 A	33 A	7,75 kW	SIM	3 Kw	4 kW	0.75 kW
	220 V - 240 V / 1N~		50 A	48,3 A	11,25 kW	SIM	4.5 Kw	6 kW	0.75 kW
	230 V / 3~		20 A	17.7 A	6,75 kW	ALT	4.5 Kw	6 kW	0.75 kW
230 V / 3~		32 A	29 A	11,25 kW	SIM	4.5 Kw	6 kW	0.75 kW	

Tables for hood type dishwashers

Entry and exit tables



General characteristics





- Wide range of entry / exit and prewashing tables, to provide solutions for every need and space.
- Designed for 500 x 500 mm dishwashing baskets.
- Quick installation and easy connection to the dishwasher.
- No holes on the surface.

- Constructed in AISI-304 stainless steel (18/10). 40 x 40 mm square tubular legs in AISI-304 stainless, adjustable in height.
- Deep anti-drip profiles completely folded with lower edge for safe and easy cleaning.

Equipment:

- 100 mm splashback (P).
- Embedded bowl (F), fully integrated in the top.
- Bowl dimensions: 450 x 450 x 250 mm.
- Lower rack (E).
- Waste scraping hole with rubber ring (O).
- Shower kit (GD) for prewashing tables.

Entry / exit tables

	MODEL	CODE	TO PLACE ON THE	EQUIPMENT (*)	DIMENSION (mm)	€
	MP-620-I	19053197	Left	P - E	620x740x880	-
	MP-620-D	19053199	Right	P - E	620x740x880	-
	MLP-1200-I E-VO	19058358	Left	P - E	1.200x740x880	-
	MLP-1200-D E-VO	19058359	Right	P - E	1.200x740x880	-

(*): E: Lower rack / P: Removable splashback









Union element for hood dishwashers

	MODEL	CODE	DESCRIPTION	DIMENSION (mm)	€
	MP-140	19061430	Element for joining two hood dishwasher in series	140x740x350	-

Prewashing tables

- Worktop 1,5 mm thick.
- Lower rack 1 mm thick
- Sink welded to the countertop

- Lower rack welded, not removable
- 4 welded legs, not removable

	MODEL	CODE	TO PLACE ON THE	EQUIPMENT (*)	DIMENSION (mm)	€
	MF-700-I E-VO	19059285	Left	P - E - F	700x740x880	-
	MF-700-D E-VO	19059286	Right	P - E - F	700x740x880	-
	MF-1200-I E-VO	19059287	Left	P - E - F	1.200x740x880	-
	MF-1200-D E-VO	19059288	Right	P - E - F	1.200x740x880	-
	MFD-1200-I E-VO	19059289	Left	P - E - F - O	1.200x740x880	-
	MFD-1200-D E-VO	19059290	Right	P - E - F - O	1.200x740x880	-
	MFD-1500-I E-VO	19059291	Left	P - E - F - O	1.500x740x880	-
	MFD-1500-D E-VO	19059292	Right	P - E - F - O	1.500x740x880	-

(*): E: Lower rack / P: Splashback / F: Bowl / O: Waste scraping hole.

Shower kit for prewashing tables

	MODEL	CODE	VALID FOR TABLES	€
	GD2 E	19085069	MF-700 / MF-1200 / MFD-1200 / MFD-1500	-

Examples of assembly



AD-125 + MP-620-I + MP-620-D



CO-110 + MF-700-I + GD2 E + MLP-1200-D

CO-142 + CO-142 +
MLP-1200-I E-VO + MP-140 + MFD-1200-D E-VO
SERIES ASSEMBLY OF TWO HOOD DISHWASHER

MODELO	CODE	DESCRIPTION	€
REPLACEMENT KIT	19059308	Kit of elements to adapt the old tables to a 2019 hood dishwasher	-

Schemes of different types of assembly

Linear assembly

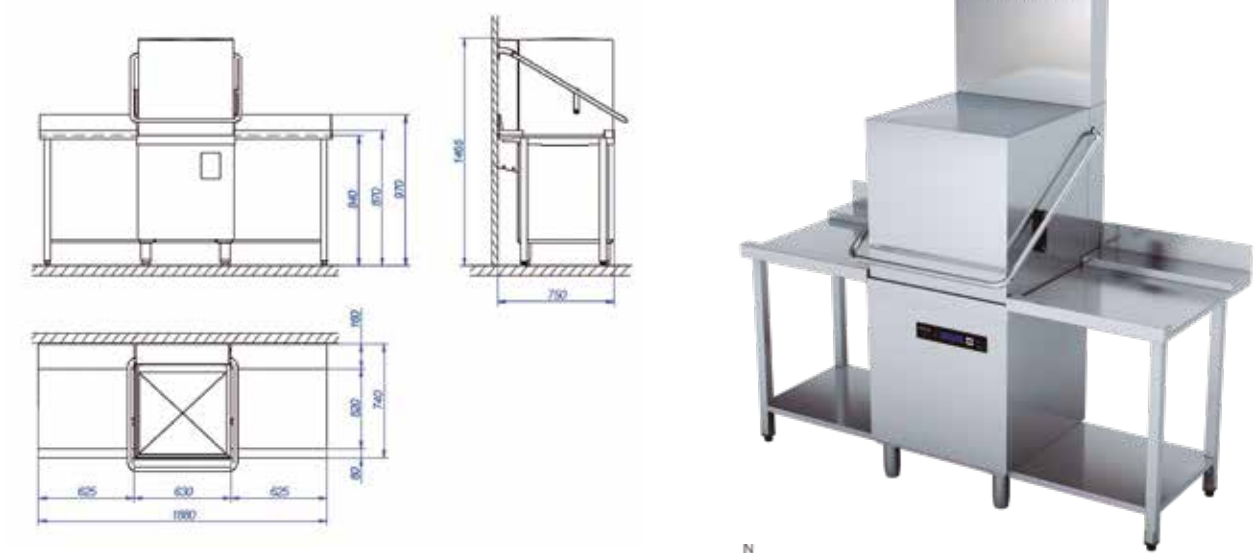



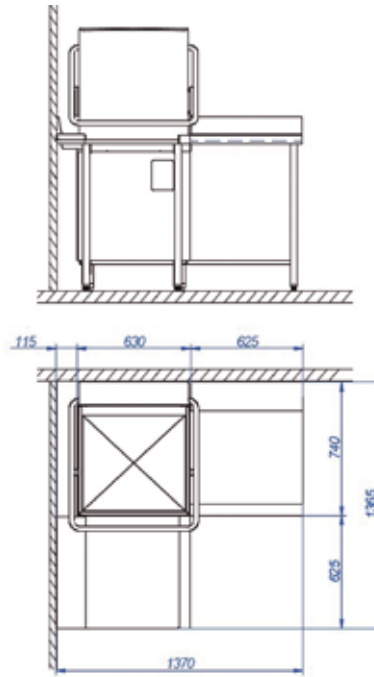

Assembly in corner



Kits to transform

Kit to transform the basic versions

MODEL	CODE	DESCRIPTION	€
 DD 	19059327	PERISTALTIC DETERGENT DOSER	-
 B-CAP 	19059326	KIT DRAIN PUMP HOOD TYPE	-

Optional marine kit for ships

MODEL	CODE	VALID FOR	CHARACTERISTICS	€
KIT MARINE HOOD	19036059	AD-125, COP-144, CO-142, CO-110	Connection for ships 440V	-