



2019 TR-EN
Ürün Katalođu / Fiyat Listesi
Product Catalogue / Price List

İş'in Mutfađı
Kitchen of Business



www.empero.com.tr



İş'in Mutfağı / Kitchen of Business

Biz Kimiz

1983 yılında Ersöz mutfak makineleri adı altında, sadece hazırlık ekipmanları üreterek, sektöre merhaba diyen şirketimiz, 2005 yılında EMPERO Markasını alarak sektöre hızlı giriş yaptı. Farklı üretim yapan 6 (altı) ayrı şirket kurarak bunları EMPERO GROUP çatısı altında topladı. Endüstriyel mutfak sektöründe paslanmaz çelikten oluşan; hazırlık, kafeterya, bulaşıkhanesi, pişirme, soğutma ekipmanları, teşhir ürünleri, raflar, gastronom evyeler, medikal ekipmanlar, özel projeler, askeriye ve sivil toplum kuruluşları tarafından kullanılan sahra mutfak ve mobil mutfakların imalatını yaparak rakiplerine fark atmayı başardı. Ayrıca geçtiğimiz yıl İstanbul'da hizmete giren, A'dan Z'ye tüm yardımcı ekipmanların (çatal, bıçak, kaşık, yemek takımları vb.) bulunduğu 3000 m²'lik Avrupanın en büyük showroomu olan Restostore ile endüstriyel mutfak sektörünün tüm ihtiyaçlarını tek çatı altında toplamıştır.

About Us

EMPERO took its first step into the sector in 1983 with the brand of Ersöz Kitchen Equipments and in 2005 made quick enter into the sector by uniting its 6 companies, which are producing different needs of Industrial Kitchen Equipments, under the brand of EMPERO GROUP. Empero Group achieved to keep far ahead of its rivals in the market, by manufacturing; Preparation Equipments, Cafe Equipments, Dishwasher, Cooking Equipments, Cooling Equipments, Display Products, Shelves, Sahra Kitchens and Mobile Kitchens those are used by military and non-governmental organizations in Industrial Kitchen Sector as well as the requirements of all the needs for industrial kitchen industry under the same roof, thanks to new 3.000 m² showroom founded in İstanbul in this year, which includes all auxiliary equipment from A to Z (fork, knife, spoon, flatware, dinner set etc.)





Kalite ve Ar-Ge Quality and R&D

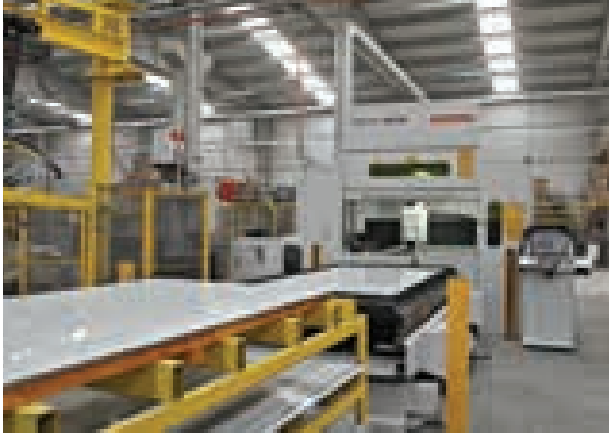
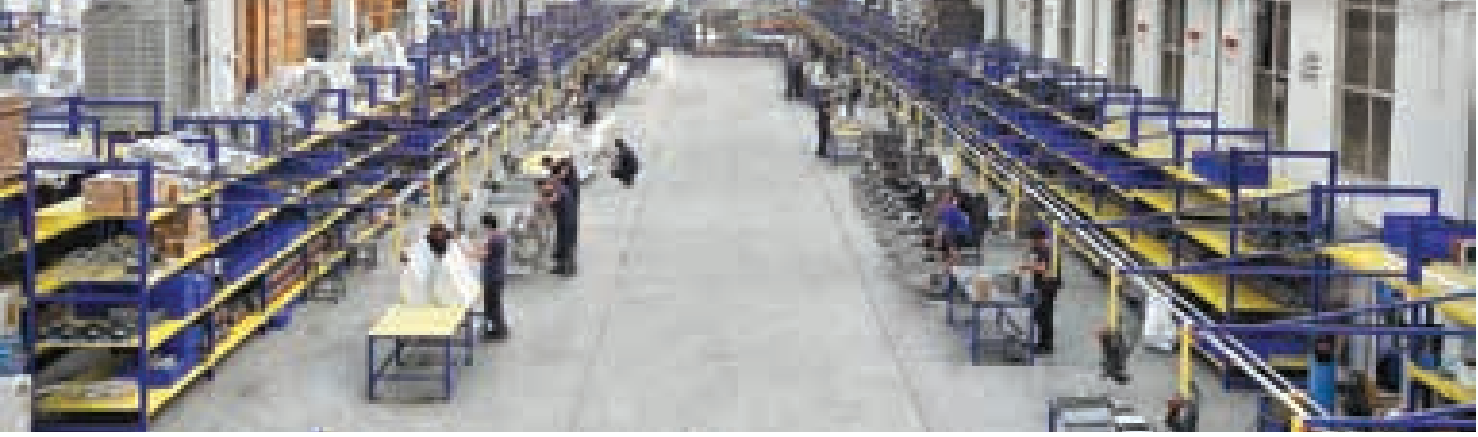

Bugün sektörde var oluşunun 36. Yılında 33.000 m²'si kapalı, 12.000 m²'si açık olmak üzere, toplamda 45.000 m² alanda faaliyet gösteren Empero, 3.000'in üzerinde farklı ürünü aynı çatı altında üreterek dünyada eşi ve benzeri olmayan modern üretim tesislerindeki, en üst teknolojiye sahip makine parkı ile profesyonel mutfakların çözüm ortağı olduğu gibi; dünya markası olma yolunda hızlı bir şekilde ilerlemektedir. 500'ün üzerinde imalat personeli ile üretilen ürünlerini, 50'nin üzerinde idari ve satış personelinin disiplinli çalışmaları ile yurtiçinde 300 ve yurtdışında 70 ülkede 290'a yakın bayi ve satış noktaları sayesinde ürünlerini pazara sunmaktadır. 125'in üzerinde yetkili servis ağı ile işin mutfağında kusursuz hizmet sunarak Türkiye'de sektöründe lider firma olmuştur.. Her geçen gün daha da büyüyen Empero, ürünlerinin % 52'sini başta Avrupa ülkeleri olmak üzere, 70 ten fazla ülkeye ihraç ederek ülke ekonomisine katkı sağladığı gibi, dünyanın en hızlı büyüyen firmaları arasında yer almayı başarmıştır.



Today, at the 36 th Year of its existence, Empero is extending its area to 45.000 square meter , 33.000 square meter area of which is indoor, and 12.000 square meter outdoor, besides manufacturing 3000 different type of products under the same roof with its high technology machine park at its unique facility on the world, being solution partner of Industrial kitchens and continues moving on the way of by being a World wide known Brand Mark. Empero became the leading company of sector by presenting its products, which are produced by over 500 production staff, to the market with the disciplined efforts of over 50 administrative and Sales staff at its 300 domestic and 290 abroad Sales points in 70 countries. Providing flawless service in the Kitchen of business with its over 125 authorized service and keep growing with each passing day, Empero besides contributing to country economy with its export to 70 countries, 52% of those export goes to the Europe.Empero achieves being one of the fastest growing companies on the world.





Türkiye’ de üretimi olmayan birçok kaliteli ürünü, JP markası adı altında ülkeye ilk defa ithal ederek iç piyasaya sunan EMPERO, kendi ürettiği ürünlerini de dünyanın her yerinde kolay kullanılabilir şekilde tasarlayarak üretiyor. Bu sayede son kullanıcı ve bayilerine maksimum memnuniyet sunuyor.

Yenilikçi çizgisini kaliteden ödün vermeden koruyan EMPERO, işin mutfağında kaliteli ürün ve hizmet sunabilmek için çalışan, üretim yaptığı her alanda liderliği hedefleyen bir firma olmuştur. Piyasada olmayan ürünleri üretmek ve üretimi daha önce yapılmış ürünleri daha kullanışlı hale getirmek adına Ar-Ge çalışmalarına da büyük önem veren Empero, endüstriyel mutfağa yeni bir anlayış getirerek, her alana ve bütçeye uygun etkili çözümler sunuyor. Bu doğrultuda sürekli kendisini geliştiren, araştıran ve çağın ihtiyaçlarına cevap verebilmek adına sürekli yatırım yapan EMPERO, dünya standartlarında yapılan kusursuz üretimler ve satış sonrası verilen hizmetler sayesinde bugün Türkiye’nin en büyüğü olmayı başarmıştır.





Destek
Support



Besides succeeding to be focus of interest in Turkey by adding many high quality imported products, that are not produced in Turkey, to its product portfolio with the brand of JP, EMPERO also designs their products to be used easily everywhere in the world. Thus provides maximum contentment to its distributors and users. EMPERO, keeping its innovative style without compromising from its policy of quality, aims to be the leading company of sector in every field it makes production. To produce products which are not produced before and to improve products which are already in use Empero gives big importance to R&D to serve appropriate solutions to all fields and budgets by bringing new understandings to the sector. With this understanding ,always continues making research, improving and investing, EMPERO achieves to be the biggest company of Turkey today with flawless production and after sale support. All products that are presented by the signature of EMPERO, reflects the pleasure of quality and comfort to you.



Söz konusu mutfakta
kalite ise, varılacak nokta
Empero'dur!

If mentioned topic is quality
in Kitchen, EMPERO is the
point that will be reached!

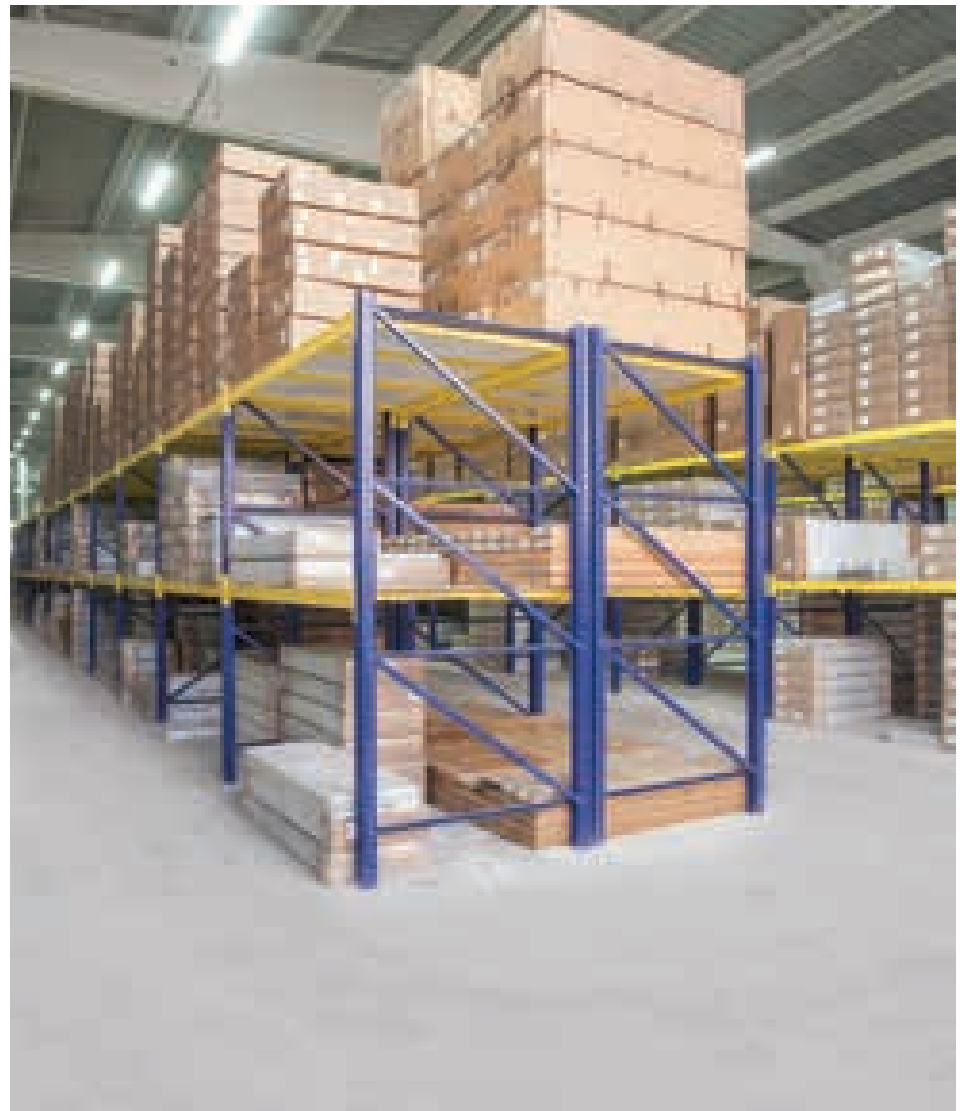

Hazırlık Ekipmanları

Preparation Equipment



İş'in Mutfağı / Kitchen of Business

empero@empero.com.tr





- * **Gn Küvet Vakumlama Kiti / Vacuum Packing Kit / Gn Usage**
- * **Sebze Doğrama Makineleri / Vegetable Cutter**
- * **Soğan Doğrama Makineleri / Cutter**
- * **Sebze Parçalama Makinesi / Cutter Mixer**
- * **Öğütücü ve Sebze Parçalama Makinesi / Grinder and Cutter Mixer**
- * **Spiral Hamur Yoğurma Makineleri (Çift Devirli) / Spiral Dough Mixers (Double Speed)**
- * **Spiral Hamur Yoğurma Makineleri (Tek Devirli) / Spiral Dough Mixer (Mono Speed)**
- * **Hamur Yoğurma Makineleri / Dough Kneading Machines**
- * **Hamur Açma Makineleri / Dough Roller**
- * **Mikserler (Üç Hızlı) / Planetary Mixers (3 Speed)**
- * **Mikserler (Hız Kontrollü) / Planetary Mixers (Speed Control)**
- * **Et Kıyma Makineleri / Meat Miners**
- * **Et Kıyma Makineleri / Meat Miners**
- * **Soğutmalı Et Kıyma Makineleri / Refrigerated Meat Miners**
- * **Plus Et Kıyma Makineleri / Refrigerated Meat Miners**
- * **Soğutmalı Plus Et Kıyma Makineleri / Plus Refrigerated Meat Miners**
- * **Et ve Kemik Testeresi / Anodized Bone Saw**
- * **Sebze ve Salata Kurutma Makinesi / Salad and Vegetable Dryer**
- * **Patates Soyma Makineleri / Potato Peelers**
- * **Tulumba ve Köfte Şekillendirme Makineleri / Semolina Pasta Preparation and Meatball Shapers**
- * **Lokma ve Tulumba Tatlı Makineleri / Doughnut and Tulumba Dessert Machine**
- * **Lokma ve Tulumba Tatlı Makineleri / Doughnut and Tulumba Dessert Machine**
- * **Çatal Kaşık Parlatici / Cutlery Polisher**
- * **Bardak Kurutuu / Glass Dryer**
- * **Ekmek Dilimleme Makinesi / Bread Slicer**
- * **Simit & Sandviç Kesme Makinesi / Pretzel & Sandwich Slicer**
- * **Ekmek Dilimleme Makineleri / Bread Slicers**
- * **Sıcaklık Dolabı / Hot Cupboard**
- * **Sıcak Banket Arabaları / Hot Banquet Trolleys**
- * **Soğuk Banket Arabaları / Cold Banquet Trolleys**
- * **Çekmeceli Isıtma Ünitesi / Drawer Warmer**
- * **Bıçak Sterilizatörü / Knife Sterilizer**
- * **Dizden Kumandalı El Yıkama Evyesi / Knee Operating Handwash Basin**
- * **Paspas Yıkama Evyesi / Janitorial Sink Unit**
- * **Kumpir Fırınları / Potato Baking Ovens**
- * **Profesyonel Duvar Tip Izgara / Professional Wall Type Grill**
- * **Tabak Kapatma Makinesi / Meal Seal Machine**
- * **Streç Makinesi / Stretching Machine**
- * **Vakum Makineleri / Vacuum Machines**
- * **Piliç Kızartma Makineleri (Elektrikli) / Electrical Chicken Rotisserie**
- * **Piliç Kızartma Makineleri (Gazlı) / Gas Chicken Rotisserie**
- * **Plus Piliç Kızartma Makineleri / Plus Chicken Rotisserie**
- * **Servis Arabaları / Service Trolleys**
- * **Plastik Mama Sandalyesi / Plastic Baby Feeding Chair**
- * **Plastik Servis Arabaları / Plastic Service Trolleys**

Gn Küvet Vakumlama Kiti

Vacuum Packing Kit / Gn Usage



Vakum Makinesi

Vacuum Machine

Kod Code	Ürün Adı Description	Ebatlar Dimension mm			Ağırlık Weight kg	Net Net m³	Güç Power kw	Fiyatı Price Euro
		a	b	c				
EMP.VCM.01-GN	Vakum Makinesi Vacuum Machine	400	550	460	36	0.10	0.4	1.100



Vac-Norm Küvetler

Vac-Type Gn Container

Kod Code	Ürün Adı Description	Ebatlar Dimension mm			Kapasite Capacity lt	Fiyatı Price Euro
		a	b	c		
EMP.GN.100	Vac-Norm Küvetler 1/1-100 GN Vac-Type Gn Container 1/1-100 GN	530	325		15	35
EMP.GN.150	Vac-Norm Küvetler 1/1-150 GN Vac-Type Gn Container 1/1-150 GN	530	325		20,5	50
EMP.GN.200	Vac-Norm Küvetler 1/1-200 GN Vac-Type Gn Container 1/1-200 GN	530	325		27	60

Gn Kalınlığı : 1.2 mm / Gn Thickness Is 1.2 mm

Vac-Norm Küvet Kapakları

Vac-Type Gn Container Lids

Kod Code	Ürün Adı Description	Fiyatı Price Euro
EMP.GN.K	Vac-Norm Küvet Kapakları 1/1 Kapak / 1/1 Lid Vac-Type Gn Container 1/1-100 GN	90

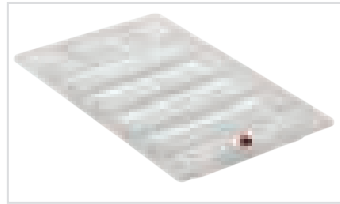

Conta ve Sübap Fiyata Dahildir.
Gasket and Valve are Included In Lids Price.

Vac-Norm Kapak Contası

Vac-Type Gn Lids Gasket

Kod Code	Ürün Adı Description	Fiyatı Price Euro
EMP.G.11	Vac-Norm Kapak Contası - Harici Conta Vac-Type Gn Lids Gasket - External Gasket	20

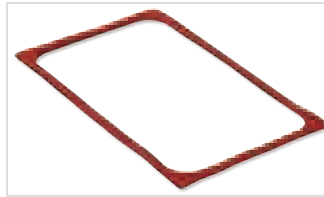

Vac-Norm Sübap

Vac-Type Valve

Kod Code	Ürün Adı Description	Fiyatı Price Euro
EMP.V.11	Vac-Norm Sübap Vac-Type Valve	5



Sıvı Ürünlerin Vakumlanması İçin Uygunur.
Suitable for the Purpose of Vacuuming Liquids

Türkçe

VAKUM MAKİNESİ

EMP.VCM.01-GN

- 220 V. 50 Hz elektrik bağlantısı.
- 10 m³/h pompa kapasitesi.
- Otomatik kontrol.
- Paslanmaz çelik gövde.

English

VACUUM MACHINE

EMP.VCM.01-GN

- 220 V. 50 Hz electric connection.
- Pump capacity: 10m³/h
- Automatic control.
- Stainless steel body.

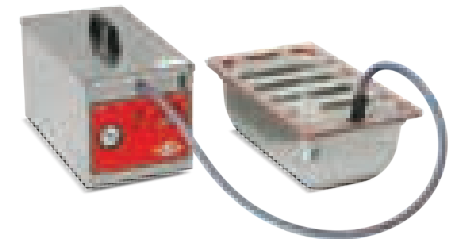

EMP.VCM.01-GN + EMP.GN.150 + EMP.GN.K

Sebze Doğrama Makineleri
Vegetable Cutter

Kod Code	Ürün Adı Description	Ebatlar Dimension mm			Ağırlık Weight kg	Net Net m³	Kapasite Capacity kg/saat-kg/time	Fiyatı Price Euro
		a	b	c				
EMP.300	Sebze Doğrama Makinesi Vegetable Cutter	418	356	501	29	0.07	300	1.000

Kod Code	Ürün Adı Description	Ebatlar Dimension mm			Ağırlık Weight kg	Net Net m³	Fiyatı Price Euro
		a	b	c			
EMP.300-AS	Sebze Doğrama Makinesi + Alt Stand Vegetable Cutter + Bottom Stand	540	918	850	42	0.17	1.235

Türkçe

SEBZE DOĞRAMA MAKİNELERİ

EMP.300

- 0.55 Kw 1400 D/Dk-220 V motor gücü.
- Paslanmaz çelik bıçaklar.
- Kolay değiştirilebilir bıçaklar.
- Güvenlik sensörü.
- Paslanmaz çelik gövde.

Standart Bıçaklar

- 1- 1.5-8 mm ayarlanabilir dilimleme bıçağı.
- 2- 5 mm kalınlığında rende.
- 3- 7 mm kalınlığında rende.

English

VEGETABLE CUTTER

EMP.300

- Motor power:0.55 Kw 1400 rpm -220 V
- Stainless steel blades.
- Blades can be easily removed for cleaning.
- Safety switch.
- Stainless steel body.

Standard Blades

- 1- 1.5-8 mm adjustable slicer blade.
- 2- 5 mm thickness grater.
- 3- 7 mm thickness grater.

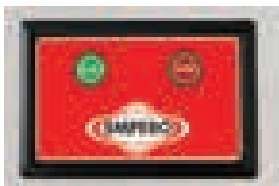

Su geçirmez touch panel kontrol
Water proof touch panel control

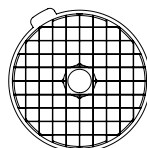
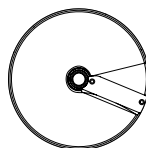
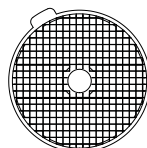
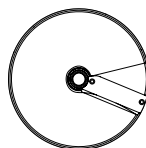
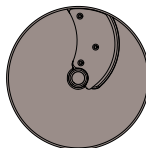
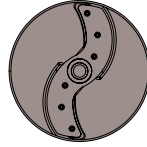

Kod Code	Ürün Adı Description	Fiyatı Price Euro
EMP.300 - F.01	Ayarlanabilir Disk / Adjustable Disc	80

Kod Code	Ürün Adı Description	Fiyatı Price Euro
EMP.300 - F.03	5 mm Rende / 5 mm Grater	70

Kod Code	Ürün Adı Description	Fiyatı Price Euro
EMP.300 - F.04	7 mm Rende / 7 mm Grater	70

Kod Code	Ürün Adı Description	Fiyatı Price Euro
EMP.300 - F.06 + F.07	Parmak Patates Bıçağı + Alt Diski French Fries Blade + Disc	100

Kod Code	Ürün Adı Description	Fiyatı Price Euro
EMP.300 - F.11 + F.08	10x10 Kubik Disk + Bıçağı 10x10 Cubic Disc + Blade	100

Kod Code	Ürün Adı Description	Fiyatı Price Euro
EMP.300 - F.12 + F.09	20x20 Kubik Disk + Bıçağı 20x20 Cubic Disc + Blade	100

Alüminyum Üst Gövde
Aluminium Top Body

Soğan Doğrama Makineleri Cutter



Kod Code	Ürün Adı Description	Ebatlar Dimension mm			Ağırlık Weight kg	Net Net m³	Kapasite Capacity lt	Fiyatı Price Euro
		a	b	c				
SD.01Y	Soğan Doğrama Makinesi Cutter	292	490	365	20	0.05	8	550

Türkçe

SOĞAN DOĞRAMA MAKİNELERİ

SD.01Y

- 0,37 Kw 1400 D/Dk-220V motor gücü.
- 240 mm çapında 180 mm derinliğinde paslanmaz çelik kazan.
- Güvenlik sensörü.
- Paslanmaz gövde ve kazan.

English

CUTTER

SD.01Y

- Motor power:0,37 Kw 1400 rpm -220V
- Bowl dimension(diameter/depth): 240 mm/180 mm.
- Safety switch.
- Stainless steel body and bowl.



Kod Code	Ürün Adı Description	Ebatlar Dimension mm			Ağırlık Weight kg	Net Net m³	Kapasite Capacity lt	Fiyatı Price Euro
		a	b	c				
EMP.350	Soğan Doğrama Makinesi Cutter	333	262	555	19	0.05	8	625

Türkçe

SOĞAN DOĞRAMA MAKİNELERİ

EMP.350

- 0,37 Kw 1400 D/Dk-220V motor gücü.
- 240 mm çapında 180 mm derinliğinde paslanmaz çelik kazan.
- Güvenlik sensörü.
- Paslanmaz gövde ve kazan.

English

CUTTER

EMP.350

- Motor power:0,37 Kw 1400 rpm -220V
- Bowl dimension(diameter/depth): 240 mm/180 mm.
- Safety switch.
- Stainless steel body and bowl.

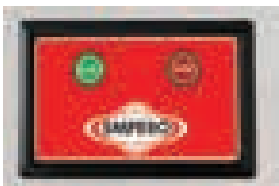

**Su geçirmez touch panel kontrol
Water proof touch panel control**

Sebze Parçalama Makinesi
Cutter Mixer

Kod Code	Ürün Adı Description	Ebatlar Dimension mm			Ağırlık Weight kg	Net Net m³	Kapasite Capacity lt	Fiyatı Price Euro
		a	b	c				
SD.15	Sebze Parçalama Makinesi Cutter Mixer	380x623x512			46	0.12	15	1.315

Türkçe

SEBZE PARÇALAMA MAKİNESİ

SD.15

- 0.60-0.90 Kw 750 / 1500/Dk motor gücü.
- 380 V çalışma voltajı.
- 290 mm çapında 220 mm derinliğinde paslanmaz çelik kazan.
- Kolay çıkarılabilir bıçak ve kazan.
- Çift devirli zaman ayarlı dijital kontrol panosu.
- Güvenlik sensörü.
- Paslanmaz gövde ve kazan.

English

CUTTER MIXER

SD.15

- Motor power:0.60-0.90 Kw 750 / 1500 rpm.
- 380 V operating voltage.
- Bowl dimension(diameter/depth): 290 mm/220 mm.
- Easy removable blade and bowl.
- Double circuit timer and digital control panel.
- Safety switch.
- Stainless steel body and bowl.



Kod Code	Ürün Adı Description	Ebatlar Dimension mm			Ağırlık Weight kg	Net Net m³	Kapasite Capacity lt	Fiyatı Price Euro
		a	b	c				
SD.07	Sebze Parçalama Makinesi Cutter Mixer	640x615x1045			60	0.41	20	1.835

Türkçe

SEBZE PARÇALAMA MAKİNESİ

SD.07

- 1.5/2.5 Kw 750 / 1500 D/Dk-380 V motor gücü.
- Kolay çıkarılabilir bıçak ve kazan.
- Çift devirli zaman ayarlı dijital kontrol panosu.
- Güvenlik sensörü.
- Paslanmaz gövde ve kazan.

English

CUTTER MIXER

SD.07

- Motor power:1.5/2.5 Kw 750 / 1500 rpm -380 V
- Easy removable blade and bowl.
- Double circuit timer and digital control panel.
- Safety switch.
- Stainless steel body and bowl.



Kod Code	Ürün Adı Description	Ebatlar Dimension mm			Ağırlık Weight kg	Net Net m³	Kapasite Capacity lt	Fiyatı Price Euro
		a	b	c				
SD.07-22	Hız Kontrollü Sebze Parçalama Makinesi Speed Control Cutter Mixer	640x615x1045			60	0.41	20	1.935

Türkçe

HIZ KONTROLLÜ
SEBZE PARÇALAMA MAKİNESİ

SD.07-22

- 2.5 Kw 1500 D/Dk-220 V motor gücü.
- Kolay çıkarılabilir bıçak ve kazan.
- Çift devirli zaman ayarlı dijital kontrol panosu.
- Güvenlik sensörü.
- Paslanmaz gövde ve kazan.

English

SPEED CONTROL CUTTER MIXER

SD.07-22

- Motor power:2.5 Kw 1500 rpm -220 V
- Easy removable blade and bowl.
- Double circuit timer and digital control panel.
- Safety switch.
- Stainless steel body and bowl.

Öğütücü ve Sebze Parçalama Makinesi Grinder and Cutter Mixer



Kod Code	Ürün Adı Description	Ebatlar Dimension mm			Ağırlık Weight kg	Net Net m³	Kapasite Capacity lt	Fiyatı Price Euro
		a	b	c				
SD.09	Sebze Parçalama Makinesi Cutter Mixer	718x684x1245			70	0.61	50	2.200

Türkçe

SEBZE PARÇALAMA MAKİNESİ

SD.09

- 3.5/5.5 Kw 750 / 1500 D/Dk-380 V motor gücü.
- Kolay çıkarılabilir bıçak ve kazan.
- Çift devirli zaman ayarlı dijital kontrol panosu.
- Güvenlik sensörü.
- Paslanmaz gövde ve kazan.

English

CUTTER MIXER

SD.09

- Motor power: 3.5/5.5 Kw 750 / 1500 rpm -380 V
- Easy removable blade and bowl.
- Double circuit timer and digital control panel.
- Safety switch.
- Stainless steel body and bowl.



Kod Code	Ürün Adı Description	Ebatlar Dimension mm			Ağırlık Weight kg	Net Net m³	Kapasite Capacity gr/sefer-gr/run	Fiyatı Price Euro
		a	b	c				
SD.06	Öğütücü Grinder	399x285x410			18	0.05	800	395

Türkçe

ÖĞÜTÜCÜ

SD.06

- 300-500 W- 9000 D/Dk-220V motor gücü.
- 240 mm çapında 110 mm derinliğinde paslanmaz çelik kazan.
- Güvenlik sensörü.
- Paslanmaz gövde ve kazan.

English

GRINDER

SD.06

- Motor power:300-500 W-9000 rpm -220V
- Bowl dimension(diameter/depth): 240 mm/110 mm.
- Safety switch.
- Stainless steel body and bowl



Spiral Hamur Yoğurma Makineleri (Çift Devirli)
Spiral Dough Mixers (Double Speed)

Kod Code	Ürün Adı Description	Ebatlar Dimension mm			Ağırlık Weight kg	Net Net m³	Kazan Ebatları Bowl Size mm	Un Kap. Flour Cap. kg	Kapasite Capacity lt	Fiyatı Price Euro
		a	b	c						
SH.01	Spiral Hamur Yoğurma Mak 30 kg Spiral Dough Mixer 30 kg	440	790	958	179	0.33	400x260	12	30	2.400
SH.02	Spiral Hamur Yoğurma Mak 50 kg Spiral Dough Mixer 50 kg	545	924	1052	212	0.53	500x300	20	50	2.830
SH.03	Spiral Hamur Yoğurma Mak 60 kg Spiral Dough Mixer 60 kg	620	1040	1100	245	0.71	600x315	35	60	3.350

Türkçe

SİRAL HAMUR YOĞURMA MAKİNELERİ (ÇİFT DEVİRLİ)

SH.01

- 1.0 - 1.7 Kw 750 / 1500 D / Dk. 380 V motor gücü.
- İki hızlı çalışabilen hamur karıştırma kolu.
- 400 mm çapında 260 mm derinliğinde paslanmaz çelik kazan.
- Çift devirli zaman ayarlı dijital kontrol panosu.
- Acil stop
- Paslanmaz çelik hamur karıştırma kolu ve kazan.

SH.02

- 1.5 - 2.5 Kw 750 / 1500 D / Dk. 380 V motor gücü.
- İki hızlı çalışabilen hamur karıştırma kolu.
- 500 mm çapında 300 mm derinliğinde paslanmaz çelik kazan.
- Çift devirli zaman ayarlı dijital kontrol panosu.
- Acil stop.
- Paslanmaz çelik hamur karıştırma kolu ve kazan.

SH.03

- 1.5 - 2.5 Kw 750 / 1500 D / Dk. 380 V motor gücü.
- İki hızlı çalışabilen hamur karıştırma kolu.
- 600 mm çapında 315 mm derinliğinde paslanmaz çelik kazan.
- Çift devirli zaman ayarlı dijital kontrol panosu.
- Acil stop.
- Paslanmaz çelik hamur karıştırma kolu ve kazan.

English

SPIRAL DOUGH MIXER KNEADER (DOUBLE SPEED)

SH.01

- Motor power: 1.0 - 1.7 Kw - 750 / 1500 rpm 380 V
- Two speed dough mixer arm.
- Bowl dimension (diameter / depth): 400 mm / 260 mm
- Equipped with double circuit timer and digital control panel.
- Emergency stop.
- Stainless steel bowl and dough mixer arm.

SH.02

- Motor power: 1.5 - 2.5 Kw - 750 / 1500 rpm 380 V
- Two speed dough mixer arm.
- Bowl dimension (diameter / depth): 500 mm / 300 mm
- Equipped with double circuit timer and digital control panel.
- Emergency stop.
- Stainless steel bowl and dough mixer arm.

SH.03

- Motor power: 1.5 - 2.5 Kw - 750 / 1500 rpm 380 V
- Two speed dough mixer arm.
- Bowl dimension (diameter / depth): 600 mm / 315 mm
- Equipped with double circuit timer and digital control panel.
- Emergency stop.
- Stainless steel bowl and dough mixer arm.

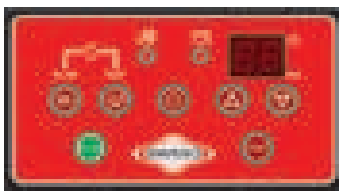

Su geçirmez touch panel kontrol
Water proof touch panel control

Spiral Hamur Yoğurma Makineleri (Tek Devirli) Spiral Dough Mixer (Mono Speed)



Kod Code	Ürün Adı Description	Ebatlar Dimension mm			Ağırlık Weight kg	Net Net m³	Kazan Ebatları Bowl Size mm	Un Kap. Flour Cap. kg	Kapasite Capacity lt	Fiyatı Price Euro
		a	b	c						
SH.04	Spiral Hamur Yoğurma Makinesi 15 kg Spiral Dough Mixer, 15 kg	385x756x907			100	0.31	360x210	7	15	1.625
SH.05	Spiral Hamur Yoğurma Makinesi 30 kg Spiral Dough Mixer, 30 kg	440x785x958			125	0.53	400x260	12	30	2.000
SH.06	Spiral Hamur Yoğurma Makinesi 50 kg Spiral Dough Mixer, 50 kg	543x924x1052			150	0.73	500x300	20	50	2.250

Türkçe

SPIRAL HAMUR YOĞURMA MAKİNELERİ (TEK DEVİRLİ)

SH.04

- 1.1 Kw 900 D/Dk 380 V motor gücü.
- 360 mm çapında 210 mm derinliğinde paslanmaz çelik kazan.
- Manuel zaman ayarı.
- Acil stop.
- Paslanmaz çelik hamur karıştırma kolu ve kazan.

SH.05

- 1.5 Kw 900 D/Dk 380 V motor gücü.
- 400 mm çapında 260 mm derinliğinde paslanmaz çelik kazan.
- Manuel zaman ayarı.
- Acil stop.
- Paslanmaz çelik hamur karıştırma kolu ve kazan.

SH.06

- 1.5 Kw 900 D/Dk 380 V motor gücü.
- 500 mm çapında 300 mm derinliğinde paslanmaz çelik kazan.
- Manuel zaman ayarı.
- Acil stop.
- Paslanmaz çelik hamur karıştırma kolu ve kazan.

English

SPIRAL DOUGH MIXER KNEADER (MONO SPEED)

SH.04

- Motor power:1.1 Kw 900 rpm 380 V
- Bowl dimension(diameter/depth): 360 mm/210 mm.
- Equipped with Timer
- Emergency stop.
- Stainless steel bowl and dough mixer arm

SH.05

- Motor power:1.5 Kw 900 rpm 380 V
- Bowl dimension(diameter/depth): 400 mm/260 mm.
- Equipped with Timer
- Emergency stop.
- Stainless steel bowl and dough mixer arm

SH.06

- Motor power:1.5 Kw 900 rpm 380 V
- Bowl dimension(diameter/depth): 500 mm/300 mm.
- Equipped with Timer
- Emergency stop.
- Stainless steel bowl and dough mixer arm.



Pizza hamuru yoğurmak için kullanılır.Sert hamurların yoğurulması için kullanılmaz.

Operates in purpose of kneading pizza dough.

Hamur Yoğurma Makineleri
Dough Kneading Machines

Kod Code	Ürün Adı Description	Ebatlar Dimension mm			Ağırlık Weight kg	Net Net m³	Kazan Ebatları Bowl Size mm	Un Kap. Flour Cap. kg	Kapasite Capacity lt	Fiyatı Price Euro
		a	b	c						
HY.11.K	Hamur Yoğurma Makinesi 15kg (220 V) Dough Kneading Machine 15kg (220 V)	440x688x648			55	0.19	360x190	7	15	1.000
HY.12.K	Hamur Yoğurma Makinesi 15kg (380 V) Dough Kneading Machine 15kg (380 V)	440x688x648			55	0.19	360x190	7	15	935
HY.01.K	Hamur Yoğurma Makinesi 30kg (220 V) Dough Kneading Machine 30kg (220 V)	518x858x771			80	0.34	430x225	12	30	1.275
HY.02.K	Hamur Yoğurma Makinesi 30kg (380 V) Dough Kneading Machine 30kg (380 V)	518x858x771			80	0.34	430x225	12	30	1.155
HY.03.K	Hamur Yoğurma Makinesi 40kg (220 V) Dough Kneading Machine 40kg (220 V)	593x908x772			83	0.41	500x270	20	40	1.415
HY.04.K	Hamur Yoğurma Makinesi 40kg (380 V) Dough Kneading Machine 40kg (380 V)	593x908x772			83	0.41	500x270	20	40	1.340
HY.05.K	Hamur Yoğurma Makinesi 50kg (220 V) Dough Kneading Machine 50kg (220 V)	668x963x791			97	0.50	600x290	30	50	1.500
HY.06.K	Hamur Yoğurma Makinesi 50kg (380 V) Dough Kneading Machine 50kg (380 V)	668x963x791			97	0.50	600x290	30	50	1.390
HY.07.K	Hamur Yoğurma Makinesi 75kg (220 V) Dough Kneading Machine 75kg (220 V)	791x1115x882			121	0.77	750x350	50	75	1.845
HY.08.K	Hamur Yoğurma Makinesi 75kg (380 V) Dough Kneading Machine 75kg (380 V)	791x1115x882			121	0.77	750x350	50	75	1.740

Türkçe

HAMUR YOĞURMA MAKİNELERİ

HY.11.K-12.K

- 0.37 Kw 1400 D/Dk 220 V- 380 V motor gücü.
- 360 mm çapında 190 mm derinliğinde paslanmaz çelik kazan.
- Acil stop.
- Paslanmaz çelik hamur karıştırma kolu ve kazan.

HY.01.K-02.K

- 0.55 Kw 1400 D/Dk 220 V- 380 V motor gücü.
- 430 mm çapında 225 mm derinliğinde paslanmaz çelik kazan.
- Acil stop.
- Paslanmaz çelik hamur karıştırma kolu ve kazan.

HY.03.K-04.K

- 0.55 Kw 1400 D/Dk 220 V- 380 V motor gücü.
- 500 mm çapında 270 mm derinliğinde paslanmaz çelik kazan.
- Acil stop.
- Paslanmaz çelik hamur karıştırma kolu ve kazan

HY.05.K-HY.06.K

- 0.75 Kw 1400 D/Dk 220 V- 380 V motor gücü.
- 600 mm çapında 290 mm derinliğinde paslanmaz çelik kazan.
- Acil stop.
- Paslanmaz çelik hamur karıştırma kolu ve kazan.

HY.07.K-HY.08.K

- 1.10 Kw 1400 D/Dk 220 V- 380 V motor gücü.
- 750 mm çapında 350 mm derinliğinde paslanmaz çelik kazan.
- Acil stop.
- Paslanmaz çelik hamur karıştırma kolu ve kazan.

English

DOUGH KNEADING MACHINE

HY.11.K-12.K

- Motor Power:0.37 Kw 1400 rpm / 220 V-380 V
- Bowl dimension(diameter/depth): 360 mm/190 mm.
- Emergency stop.
- Stainless steel bowl and dough mixer arm.

HY.01.K-02.K

- Motor Power: 0.55 Kw 1400 rpm / 220 V-380 V
- Bowl dimension(diameter/depth): 430 mm/225 mm.
- Emergency stop.
- Stainless steel bowl and dough mixer arm.

HY.03.K-04.K

- Motor Power:0.55 Kw 1400 rpm / 220 V-380 V
- Bowl dimension(diameter/depth): 500 mm/270 mm.
- Emergency stop.
- Stainless steel bowl and dough mixer arm.

HY.05.K-HY.06.K

- Motor Power:0.75 Kw 1400 rpm / 220 V-380 V
- Bowl dimension(diameter/depth): 600 mm/290 mm
- Emergency stop.
- Stainless steel bowl and dough mixer arm.

HY.07.K-HY.08.K

- Motor Power:1.10 Kw 1400 rpm / 220 V-380 V
- Bowl dimension(diameter/depth): 750 mm/350 mm
- Emergency stop.
- Stainless steel bowl and dough mixer arm.

Hamur Açma Makineleri Dough Roller



Kod Code	Ürün Adı Description	Ebatlar Dimension mm			Ağırlık Weight kg	Net Net m³	Merdane Ölçüleri Roller Dimensions mm	Fiyatı Price Euro
		a	b	c				
EMP.HA.01	Hamur Açma Makinesi 40 cm Dough Roller 40 cm	530	550	650	41	0.17	400	1.050
EMP.HA.02	Hamur Açma Makinesi 30 cm Dough Roller 30 cm	430	550	650	37	0.14	300	945



Türkçe

HAMUR AÇMA MAKİNELERİ

EMP.HA.01-EMP.HA.02

- 0.25 Kw- 1400 D/Dk-220V motor gücü.
- Ayarlanabilir hamur kalınlığı.
- Pleksiglas koruma kapağı.
- Derlin Merdane.
- Acil stop.
- Paslanmaz çelik gövde.

English

DOUGH ROLLER

EMP.HA.01-EMP.HA.02

- Motor power:0.25 Kw- 1400 rpm-220V
- Adjustable dough thickness.
- Plexiglass protection cover.
- Derlin Roller.
- Emergency stop.
- Stainless steel body.

Kod Code	Ürün Adı Description	Ebatlar Dimension mm			Ağırlık Weight kg	Net Net m³	Merdane Ölçüleri Roller Dimensions mm	Fiyatı Price Euro
		a	b	c				
EMP.HA.01.Y	Hamur Açma Makinesi 40 cm Dough Roller 40 cm	530	550	650	41	0.17	400	1.050
EMP.HA.02.Y	Hamur Açma Makinesi 30 cm Dough Roller 30 cm	430	550	650	37	0.14	300	945



Türkçe

HAMUR AÇMA MAKİNELERİ

EMP.HA.01.Y-EMP.HA.02.Y

- 0.25 Kw- 1400 D/Dk-220V motor gücü.
- Ayarlanabilir hamur kalınlığı.
- Pleksiglas koruma kapağı.
- Derlin Merdane.
- Acil stop.
- Paslanmaz çelik gövde.

English

DOUGH ROLLER

EMP.HA.01.Y-EMP.HA.02.Y

- Motor power:0.25 Kw- 1400 rpm-220V
- Adjustable dough thickness.
- Plexiglass protection cover.
- Derlin Roller.
- Emergency stop.
- Stainless steel body.

Kod Code	Ürün Adı Description	Ebatlar Dimension mm			Ağırlık Weight kg	Net Net m³	Merdane Ölçüleri Roller Dimensions mm	Fiyatı Price Euro
		a	b	c				
EMP.HA.03	Hamur Açma Makinesi 55 cm Dough Roller 55 cm	910	575	535	63	0.28	550	1.840



Türkçe

HAMUR AÇMA MAKİNELERİ

EMP.HA.03

- 0.75 Kw- 1500 D/Dk-220V motor gücü.
- Ayarlanabilir hamur kalınlığı.
- Derlin Merdane.
- Acil stop.
- Paslanmaz çelik gövde.

English

DOUGH ROLLER

EMP.HA.03

- Motor power:0.75 Kw- 1500 rpm-220V
- Adjustable dough thickness.
- Derlin Roller.
- Emergency stop.
- Stainless steel body.

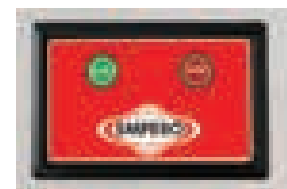

**Su geçirmez touch panel kontrol
Water proof touch panel control**

Mikserler (Üç Hızlı)
Planetary Mixers (3 Speed)

Kod Code	Ürün Adı Description	Ebatlar Dimension mm			Ağırlık Weight kg	Net Net m³	Kazan Ebatları Bowl Size mm	Kapasite Capacity lt	Fiyatı Price Euro
		a	b	c					
MK.08	Mikserler (Üç Hızlı) Planetary Mixers (3 Speed)	688	841	1270	184	0.73	360x360	30	2.750
MK.04	Mikserler (Üç Hızlı) Planetary Mixers (3 Speed)	690	888	1366	200	0.84	400x390	40	3.100
MK.06	Mikserler (Üç Hızlı) Planetary Mixers (3 Speed)	690	903	1419	205	0.88	430x445	60	3.300

Çırpma Teli
WhiskHamur Baltası
Dough HookÇırpma Paleti
Mixing Paddle

Türkçe

MİKSERLER (ÜÇ HIZLI)

MK.04-MK.06

- 1.1-1.5-1.85 Kw 950-1450-2850 D/Dk 380 V motor gücü.
- Üç hızlı çalıştırma özelliği.
- 2 adet çırpma teli.
- 1 adet hamur baltası.
- 1 adet çırpma paleti.
- Çift devirli zaman ayarlı dijital kontrol panosu.
- Güvenlik sensörü.
- Paslanmaz çelik kazan.

MK.08

- 1.1-1.5-1.85 Kw 950-1450-2850 D/Dk 380 V motor gücü.
- Üç hızlı çalıştırma özelliği.
- 2 adet çırpma teli.
- 1 adet hamur baltası.
- 1 adet çırpma paleti.
- Çift devirli zaman ayarlı dijital kontrol panosu.
- Güvenlik sensörü.
- Paslanmaz çelik kazan.

English

PLANETARY MIXERS (3 SPEED)

MK.04-MK.06

- Motor power:1.1-1.5-1.85 Kw 950-1450-2850 rpm 380 V
- Three-speed operating option.
- 2 of whisks.
- 1 of dough hook.
- 1 of mixing paddle
- Double circuit timer and digital control panel.
- Safety switch.
- Stainless steel bowl

MK.08

- Motor power:1.1-1.5-1.85 Kw 950-1450-2850 rpm 380 V
- Three-speed operating option.
- 2 of whisks.
- 1 of dough hook.
- 1 of mixing paddle
- Double circuit timer and digital control panel.
- Safety switch.
- Stainless steel bowl.

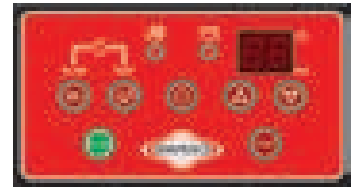
Kontrol Paneli
Control PanelSu geçirmez touch panel kontrol
Water proof touch panel control

Mikserler (Hız Kontrollü) Planetary Mixers (Speed Control)



Kod Code	Ürün Adı Description	Ebatlar Dimension mm			Ağırlık Weight kg	Net Net m³	Kazan Ebatları Bowl Size mm	Kapasite Capacity lt	Fiyatı Price Euro
		a	b	c					
EMP.10	Hız Kontrollü Mikser Speed Controlled Mixer	450	535	710	55	0.17	260x260	10	1.650

Setüstü / Countertop

Türkçe

MİKSER (HIZ KONTROLLÜ)

EMP.10

- 0,55 Kw 1400 D/Dk-220 V motor gücü.
- Hız kontrollü çalıştırma özelliği.
- 260 mm çapında 260 mm derinliğinde paslanmaz çelik kazan.
- 1 adet çırpma teli.
- 1 adet hamur baltası.
- 1 adet çırpma paleti.
- Hız kontrollü zaman ayarlı dijital kontrol panosu.
- Güvenlik sensörü.

English

MIXER (SPEED CONTROL)

EMP.10

- Motor Power: 0.55 Kw 1400 rpm 220 V
- Speed control
- S.Steel Bowl dimension(diameter/depth): 260 mm/260 mm
- 1 of whisk
- 1 of dough hook
- 1 of mixing paddle
- Equipped with speed controlled timer and digital control panel.
- Safety switch.



Kod Code	Ürün Adı Description	Ebatlar Dimension mm			Ağırlık Weight kg	Net Net m³	Kazan Ebatları Bowl Size mm	Kapasite Capacity lt	Fiyatı Price Euro
		a	b	c					
MK.07	Mikser Planetary Mixer	688	841	1270	184	0.73	360x360	30	3.135
MK.03	Mikser Planetary Mixer	690	888	1366	200	0.84	400x390	40	3.400
MK.05	Mikser Planetary Mixer	690	903	1419	205	0.88	430x445	60	3.630

Türkçe

MİKSER (HIZ KONTROLLÜ)

MK.03-MK.05

- 2.2 Kw 1400 D/Dk 220 V motor gücü.
- Hız kontrollü çalıştırma özelliği.
- 220 V çalışma voltajı.
- 2 adet çırpma teli.
- 1 adet hamur baltası.
- 1 adet çırpma paleti.
- Hız kontrollü zaman ayarlı dijital kontrol panosu.
- Güvenlik sensörü.
- Paslanmaz çelik kazan.

MK.07

- 1.5 Kw 1400 D/Dk 220 V motor gücü.
- Hız kontrollü çalıştırma özelliği.
- 220 V çalışma voltajı.
- 2 adet çırpma teli.
- 1 adet hamur baltası.
- 1 adet çırpma paleti.
- Hız kontrollü zaman ayarlı dijital kontrol panosu.
- Güvenlik sensörü.
- Paslanmaz çelik kazan.

English

MIXER (SPEED CONTROL)

MK.03-MK.05

- Motor power:2.2 Kw 1400 rpm 220 V
- Speed controlled operating option.
- 220 V operating voltage.
- 2 of whisks.
- 1 of dough hook.
- 1 of mixing paddle
- Speed controlled timer and digital control panel.
- Safety switch.
- Stainless steel bowl.

MK.07

- Motor power:1.5 Kw 1400 rpm 220 V
- Speed controlled operating option.
- 220 V operating voltage.
- 2 of whisks.
- 1 of dough hook.
- 1 of mixing paddle
- Speed controlled timer and digital control panel.
- Safety switch.
- Stainless steel bowl.

Kontrol Paneli
Control Panel

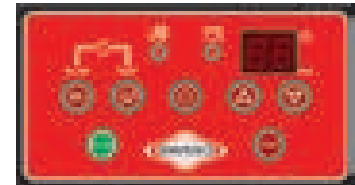

Çırpma Teli
Whisk



Hamur Baltası
Dough Hook



Çırpma Paleti
Mixing Paddle

Su geçirmez touch panel kontrol
Water proof touch panel control

Et Kıyma Makineleri
Meat Miners

Paslanmaz çelik kovan helezon, somun grubu
Stainless steel gear housing, spiral, nut group

Kod Code	Ürün Adı Description	Ebatlar Dimension mm			Ağırlık Weight kg	Net Net m³	Kapasite Capacity kg/saat-kg/hour	Fiyatı Price Euro
		a	b	c				
EMP.12.01.P	No:12 Et Kıyma Makinesi (220V) No:12 Meat Mincer (220V)	535x235x370			25	0.04	125	700
EMP.12.02.P	No:12 Et Kıyma Makinesi (380V) No:12 Meat Mincer (380V)	535x235x370			25	0.04	125	645
EMP.22.01.P	No:22 Et Kıyma Makinesi (220V) No:22 Meat Mincer (220V)	555x235x380			29	0.05	200	825
EMP.22.02.P	No:22 Et Kıyma Makinesi (380V) No:22 Meat Mincer (380V)	555x235x380			29	0.05	200	775

Türkçe

ET KIYMA MAKİNELERİ

EMP.12.01.P-EMP.12.02.P

- 0.55 Kw 1400 D/Dk-220 V/380 V motor gücü.
- Paslanmaz çelik helezon, boğaz ve boğaz somunu.
- Kolay sökülebilir et haznesi ile kolay temizlik imkanı.
- El koruma ünitesi ile güvenli çalışma imkanı.
- Paslanmaz çelik gövde.

EMP.22.01.P-EMP.22.02.P

- 0.75 Kw 1400 D/Dk-220 V/380 V motor gücü.
- Paslanmaz çelik helezon, boğaz ve boğaz somunu.
- Kolay sökülebilir et haznesi ile kolay temizlik imkanı.
- El koruma ünitesi ile güvenli çalışma imkanı.
- Paslanmaz çelik gövde.

English

MEAT MINCERS

EMP.12.01.P-EMP.12.02.P

- Motor Power:0.55 Kw 1400 rpm-220 V/380 V
- Stainless steel handwheel and spiral.
- Easy removable handwheel and easy cleaning.
- Hand protection provides safe operation.
- Stainless steel body.

EMP.22.01.P-EMP.22.02.P

- Motor Power: 0.75 Kw 1400 rpm -220 V/380 V
- Stainless steel handwheel and spiral.
- Easy removable handwheel and easy cleaning.
- Hand protection provides safe operation.
- Stainless steel body.

Et Kıyma Makineleri Meat Mincers



**Kovan helezon, somun grubu nikelaj kaplamalıdır.
Gear housing, spiral, nut group are nickel-plated.**

Kod Code	Ürün Adı Description	Ebatlar Dimension mm			Ağırlık Weight kg	Net Net m³	Kapasite Capacity kg/saat-kg/hour	Fiyatı Price Euro
		a	b	c				
EM.01	No:32 Et Kıyma Makinesi (220V) No:32 Meat Mincer (220V)	800x360x410			56	0.12	600	1.000
EM.02	No:32 Et Kıyma Makinesi (380V) No:32 Meat Mincer (380V)	800x360x410			56	0.12	600	900
EM.09	No:22 Et Kıyma Makinesi (220V) No:22 Meat Mincer (220V)	770x320x405			51	0.10	400	875
EM.10	No:22 Et Kıyma Makinesi (380V) No:22 Meat Mincer (380V)	770x320x405			51	0.10	400	785

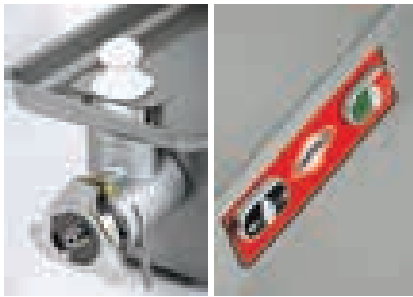

Türkçe

ET KIYMA MAKİNELERİ

EM.01 - EM.02

- 2.2 kw 1400 D/Dk-220 V / 380 V motor gücü.
- Paslanmaz çelik helezon, boğaz ve boğaz somunu.
- Kolay sökülebilir et haznesi ile kolay temizlik imkanı.
- El koruma ünitesi ile güvenli çalışma imkanı.
- Paslanmaz çelik gövde.

EM.09 - EM.10

- 1.5 kw 1400 D/Dk-220 V / 380 V motor gücü.
- Paslanmaz çelik helezon, boğaz ve boğaz somunu.
- Kolay sökülebilir et haznesi ile kolay temizlik imkanı.
- El koruma ünitesi ile güvenli çalışma imkanı.
- Paslanmaz çelik gövde.

English

MEAT MINCERS

EM.01-EM.02

- Motor Power: 2.2 kw 1400 rpm-220 V / 380 V
- Stainless steel handwheel and spiral.
- Easy removable handwheel and easy cleaning.
- Hand protection provides safe operation.
- Stainless steel body.

EM.09 - EM.10

- Motor Power: 1.5 kw 1400 rpm-220 V / 380 V
- Stainless steel handwheel and spiral.
- Easy removable handwheel and easy cleaning.
- Hand protection provides safe operation.
- Stainless steel body .

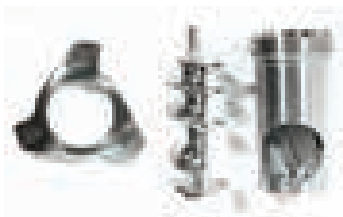

Et Kıyma Makineleri
Meat Mincers

Paslanmaz çelik kovan helezon, somun grubu
Stainless steel gear housing, spiral, nut group

Kod Code	Ürün Adı Description	Ebatlar Dimension mm			Ağırlık Weight kg	Net Net m³	Kapasite Capacity kg/saat-kg/hour	Fiyatı Price Euro
		a	b	c				
EM.01.P	No:32 Et Kıyma Makinesi (220V) No:32 Meat Mincer (220V)	800x360x410			56	0.12	600	1.365
EM.02.P	No:32 Et Kıyma Makinesi (380V) No:32 Meat Mincer (380V)	800x360x410			56	0.12	600	1.275
EM.09.P	No:22 Et Kıyma Makinesi (220V) No:22 Meat Mincer (220V)	770x320x405			51	0.10	400	1.145
EM.10.P	No:22 Et Kıyma Makinesi (380V) No:22 Meat Mincer (380V)	770x320x405			51	0.10	400	1.050

Türkçe

ET KIYMA MAKİNELERİ

EM.01.P-EM.02.P

- 2.2 kw 1400 D/Dk-220 V / 380 V motor gücü.
- Paslanmaz çelik helezon, boğaz ve boğaz somunu.
- Kolay sökülebilir et haznesi ile kolay temizlik imkanı.
- El koruma ünitesi ile güvenli çalışma imkanı.
- Paslanmaz çelik gövde.

EM.09.P-EM.10.P

- 1.5 kw 1400 D/Dk-220 V / 380 V motor gücü.
- Paslanmaz çelik helezon, boğaz ve boğaz somunu.
- Kolay sökülebilir et haznesi ile kolay temizlik imkanı.
- El koruma ünitesi ile güvenli çalışma imkanı.
- Paslanmaz çelik gövde.

English

MEAT MINCERS

EM.01.P-EM.02.P

- Motor Power: 2.2 kw 1400 rpm-220 V / 380 V
- Stainless steel handwheel and spiral.
- Easy removable handwheel and easy cleaning.
- Hand protection provides safe operation.
- Stainless steel body.

EM.09.P-EM.10.P

- Motor Power: 1.5 kw 1400 rpm-220 V / 380 V
- Stainless steel handwheel and spiral.
- Easy removable handwheel and easy cleaning.
- Hand protection provides safe operation.
- Stainless steel body .

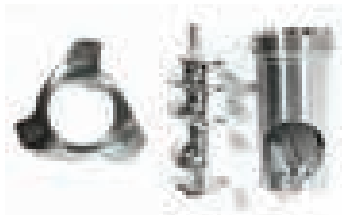

Soğutmalı Et Kıyma Makineleri Refrigerated Meat Mincers



**Paslanmaz çelik kovan helezon, somun grubu
Stainless steel gear housing, spiral, nut group**

Kod Code	Ürün Adı Description	Ebatlar Dimension mm			Ağırlık Weight kg	Net Net m ³	Kapasite Capacity kg/saat-kg/time	Fiyatı Price Euro
		a	b	c				
EM.07	No:32Soğutmalı Et Kıyma Makinesi (220V) No:32Refrigerated Meat Mincer(220V)	850x361x510			86	0.15	700	1.840
EM.08	No:32 Soğutmalı Et Kıyma Makinesi (380V) No:32 Refrigerated Meat Mincer (380V)	850x361x510			86	0.15	700	1.735

Türkçe

SOĞUTMALI ET KIYMA MAKİNELERİ

EM.07-EM.08

- 2.2 kw 1400 D/Dk-220 V / 380 V motor gücü.
- Paslanmaz çelik helezon, boğaz ve boğaz somunu.
- Et haznesi soğutma özelliği.
- Dijital kontrollü soğutma ünitesi.
- El koruma ünitesi ile güvenli çalışma imkanı.
- Paslanmaz çelik gövde.
- Kolay sökülebilir boğaz haznesi ile kolay temizlik imkanı.

English

REFRIGERATED MEAT MINCERS

EM.07-EM.08

- Motor Power: 2.2 kw 1400 rpm-220 V / 380 V
- Stainless steel handwheel and spiral.
- Refrigerated neck.
- Cooling system with digital control.
- Hand protection provides safe operation.
- Stainless steel body.
- Easy removable handwell and easy cleaning.

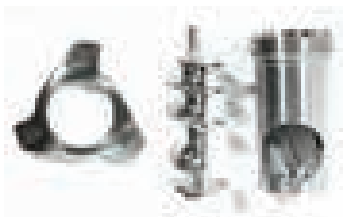

Plus Et Kıyma Makineleri
Plus Meat Miners

Kod Code	Ürün Adı Description	Ebatlar Dimension mm			Ağırlık Weight kg	Net Net m³	Kapasite Capacity kg/saat-kg/hour	Fiyatı Price Euro
		a	b	c				
EM.22.09	No:22 Plus Et Kıyma Makinesi (220V) No:22 Plus Meat Mincer (220V)	505	320	570	50	0.09	400	1.365
EM.22.10	No:22 Plus Et Kıyma Makinesi (380V) No:22 Plus Meat Mincer (380V)	505	320	550	40	0.08	400	1.235
EM.32.09	No:32 Plus Et Kıyma Makinesi (220V) No:32 Plus Meat Mincer (220V)	645	340	590	57	0.13	600	1.740
EM.32.10	No:32 Plus Et Kıyma Makinesi (380V) No:32 Plus Meat Mincer (380V)	645	340	575	47	0.12	600	1.555

Paslanmaz çelik kovan helezon, somun grubu
Stainless steel gear housing, spiral, nut group

Türkçe

PLUS ET KIYMA MAKİNELERİ

EM.22.09 ve EM.22.10 için:

- 1.5 kw 1400 D/Dk-220 V / 380 V motor gücü.

EM.32.09 ve EM.32.10 için:

- 2.2 kw 1400 D/Dk-220 V / 380 V motor gücü.
- Paslanmaz çelik helezon, boğaz ve boğaz somunu.
- Kolay sökülebilir et haznesi ile kolay temizlik imkanı.
- El koruma ünitesi ile güvenli çalışma imkanı.
- Acil stop.
- Paslanmaz çelik gövde.

English

PLUS MEAT MINCERS

EM.22.09 and EM.22.10:

- Motor Power: 1.5 kw 1400 rpm-220 V / 380 V

EM.32.09 and EM.32.10:

- Motor Power: 2.2 kw 1400 rpm-220 V / 380 V
- Stainless steel handwheel and spiral.
- Easy removable handwheel and easy cleaning.
- Hand protection provides safe operation.
- Emergency stop.
- Stainless steel body.

Soğutmalı Plus Et Kıyma Makineleri
Plus Refrigerated Meat Miners

Kod Code	Ürün Adı Description	Ebatlar Dimension mm			Ağırlık Weight kg	Net Net m³	Kapasite Capacity kg/saat-kg/time	Fiyatı Price Euro
		a	b	c				
EM.22.09-S	No:22 Soğutmalı Plus Et Kıyma Makinesi (220V) No:22 Plus Refrigerated Meat Mincer(220V)	670	340	565	50	0.12	400	1.740
EM.22.10-S	No:22 Soğutmalı Plus Et Kıyma Makinesi (380V) No:22 Plus Refrigerated Meat Mincer (380V)	670	340	545	40	0.11	400	1.555
EM.32.09-S	No:32 Soğutmalı Plus Et Kıyma Makinesi (220V) No:32 Plus Refrigerated Meat Mincer (220V)	645	340	590	57	0.13	600	2.080
EM.32.10-S	No:32 Soğutmalı Plus Et Kıyma Makinesi (380V) No:32 Plus Refrigerated Meat Mincer (380V)	645	340	575	47	0.12	600	1.875

Paslanmaz çelik kovan helezon, somun grubu
Stainless steel gear housing, spiral, nut group

Türkçe

SOĞUTMALI PLUS ET KIYMA MAKİNELERİ

EM.22.09 ve EM.22.10 için:

- 1.5 kw 1400 D/Dk-220 V / 380 V motor gücü.

EM.32.09 ve EM.32.10 için:

- 2.2 kw 1400 D/Dk-220 V / 380 V motor gücü.
- Paslanmaz çelik helezon, boğaz ve boğaz somunu.
- Dijital kontrollü soğutma ünitesi.
- El koruma ünitesi ile güvenli çalışma imkanı.
- Acil stop.
- Paslanmaz çelik gövde.

English

PLUS REFRIGERATED MEAT MINCERS

EM.22.09 and EM.22.10:

- Motor Power: 1.5 kw 1400 rpm-220 V / 380 V

EM.32.09 and EM.32.10:

- Motor Power: 2.2 kw 1400 rpm-220 V / 380 V
- Stainless steel handwheel and spiral.
- Cooling system with digital control.
- Hand protection provides safe operation.
- Emergency stop.
- Stainless steel body.



Et ve Kemik Testeresi Anodized Bone Saw



Kod Code	Ürün Adı Description	Ebatlar Dimension mm			Ağırlık Weight kg	Net Net m³	Fiyatı Price Euro
		a	b	c			
EMP.ETK.01	Et ve Kemik Testeresi Anodized Bone Saw	480	545	900	43	0.23	1.470

Türkçe

ET VE KEMİK TESTERESİ

EMP.ETK.01

- 0.75 Kw 900 d / dk 220 V. motor gücü.
- 1800 mm bant uzunluğu.
- 290 mm kesme yüksekliği.
- 195 mm kesme genişliği.
- 380x545 mm çalışma tezgahı
- Acil stop.
- Paslanmaz çelik çalışma yüzeyi ve bıçak.

English

ANODIZED BONE SAW

EMP.ETK.01

- Motor power: 0.75 Kw 900 rpm 220 V.
- Band length: 1800 mm
- Usable cut height: 290 mm
- Usable cut depth: 195 mm
- Working table: 380x545 mm
- Emergency stop.
- Stainless steel working surface and blade.



Kod Code	Ürün Adı Description	Ebatlar Dimension mm			Ağırlık Weight kg	Net Net m³	Fiyatı Price Euro
		a	b	c			
EMP.ETK.02	Et ve Kemik Testeresi - Hazneli Anodized Bone Saw - With Drawer	560	545	1560	81	0.47	1.890

Türkçe

ET VE KEMİK TESTERESİ

EMP.ETK.02

- 1.5 Kw 1400 d / dk 220 V. motor gücü.
- 2100 mm bant uzunluğu.
- 350 mm kesme yüksekliği.
- 230 mm kesme genişliği.
- 465x545 mm çalışma tezgahı
- Acil stop.
- Paslanmaz çelik çalışma yüzeyi ve bıçak.

English

ANODIZED BONE SAW

EMP.ETK.02

- Motor power: 1.5 Kw 1400 rpm 220 V.
- Band length: 2100 mm
- Usable cut height: 350 mm
- Usable cut depth: 230 mm
- Working table: 465x545 mm
- Emergency stop.
- Stainless steel working surface and blade.

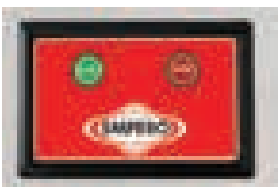

Su geçirmez touch panel kontrol
Water proof touch panel control

Sebze ve Salata Kurutma Makinesi
Salad and Vegetable Dryer

NEW

Kod Code	Ürün Adı Description	Ebatlar Dimension mm			Ağırlık Weight kg	Net Net m³	Fiyatı Price Euro
		a	b	c			
EMP.SYK.01	Elektronik Sebze Yıkama ve Kurutma Makinesi Electronic Vegetable Washer and Dryer	1300	660	850	140	0.72	4.380

Türkçe

ELEKTRONİK SEBZE YIKAMA ve KURUTMA MAKİNESİ

- 4-20 Kg yıkama kapasitesi.
- 4-10 Dk. yıkama süresi.
- 2-10 Kg Kurutma kapasitesi.
- 2-4 Dk Kurutma süresi.
- 157 Litre yıkama tank kapasitesi.
- 380 V - 1.9 Kw çalışma voltajı.
- Paslanmaz çelik gövde ve kazan.

English

ELECTRONIC VEGETABLE WASHER and DRYER

- 4-20 Kg Washer capacity.
- 4-10 Min. Washer time.
- 2-10 Kg drying capacity.
- 2-10 Min drying time.
- 157 Liter Washing tank capacity.
- 380 V - 1.9 kw operating voltage.
- Stainless steel body and tank.



Kod Code	Ürün Adı Description	Ebatlar Dimension mm			Ağırlık Weight kg	Net Net m³	Kapasite Capacity lt	Fiyatı Price Euro
		a	b	c				
SY.40-09	Sebze ve Salata Kurutma Makinesi (220 V) Salad and Vegetable Dryer (220 V)	522	800	1068	53	0.47	40	1.840
SY.40-10	Sebze ve Salata Kurutma Makinesi (380 V) Salad and Vegetable Dryer (380 V)	522	800	1068	53	0.47	40	1.735
SY.60-09	Sebze ve Salata Kurutma Makinesi (220 V) Salad and Vegetable Dryer (220 V)	552	800	1168	60	0.52	60	2.100
SY.60-10	Sebze ve Salata Kurutma Makinesi (380 V) Salad and Vegetable Dryer (380 V)	552	800	1168	60	0.52	60	2.200

Türkçe

SEBZE VE SALATA KURUTMA MAKİNESİ

- Sebzelerin birkaç saniye içinde kurutulmasını sağlar.
- 0.55 kw 1400 D/Dk-220 V / 380 V motor gücü.
- Zaman ayarlı dijital kontrol panosu.
- Paslanmaz çelik gövde.

English

SALAD AND VEGETABLE DRYER

- Operates in order to dry vegetables in a few minutes.
- Motor Power: 0.55 kw 1400 rpm-220 V / 380 V
- Equipped with timer and control panel.
- Stainless steel body.



Su geçirmez touch panel kontrol
Water proof touch panel control

Patates Soyma Makineleri Potato Peelers



Kod Code	Ürün Adı Description	Ebatlar Dimension mm			Ağırlık Weight kg	Net Net m³	Kapasite Capacity kg	Fiyatı Price Euro
		a	b	c				
PS.05	Patates Soyma Makinesi (220V) Potato Peeler (220V)	500x700x920			41	0.31	10	1.320
PS.06	Patates Soyma Makinesi (380V) Potato Peeler (380V)	500x700x920			41	0.31	10	1.230
PS.07	Patates Soyma Makinesi (220V) Potato Peeler (220V)	522x800x1068			53	0.47	20	1.650
PS.08	Patates Soyma Makinesi (380V) Potato Peeler (380V)	522x800x1068			53	0.47	20	1.560
PS.09	Patates Soyma Makinesi (220V) Potato Peeler (220V)	552x800x1168			60	0.52	30	1.890
PS.10	Patates Soyma Makinesi (380V) Potato Peeler (380V)	552x800x1168			60	0.52	30	1.800



Kod Code	Ürün Adı Description	Ebatlar Dimension mm			Ağırlık Weight kg	Net Net m³	Kapasite Capacity kg	Fiyatı Price Euro
		a	b	c				
PS.05-F	Filtreli Patates Soyma Makinesi (220V) Filtred Potato Peeler (220V)	500x733x1200			50	0.44	10	1.600
PS.06-F	Filtreli Patates Soyma Makinesi (380V) Filtred Potato Peeler (380V)	500x733x1200			50	0.44	10	1.500
PS.07-F	Filtreli Patates Soyma Makinesi (220V) Filtred Potato Peeler (220V)	520x833x1368			60	0.57	20	1.980
PS.08-F	Filtreli Patates Soyma Makinesi (380V) Filtred Potato Peeler (380V)	520x833x1368			60	0.57	20	1.890
PS.09-F	Filtreli Patates Soyma Makinesi (220V) Filtred Potato Peeler (220V)	552x833x1468			67	0.68	30	2.300
PS.10-F	Filtreli Patates Soyma Makinesi (380V) Filtred Potato Peeler (380V)	552x833x1468			67	0.68	30	2.175



Türkçe

PATATES SOYMA MAKİNELERİ

PS.05-PS.06

- 0.55 kw 900 D/Dk-220 V / 380 V motor gücü.
- 400x380 mm paslanmaz çelik soyma haznesi.
- Zaman ayarlı dijital kontrol panosu.
- Uzun süre kullanılabilen güçlü zımpara.
- 1-2 dk patates soyma süresi.
- Paslanmaz çelik gövde.

PS.07-PS.08

- 0.75 kw 900 D/Dk-220 V / 380 V motor gücü.
- 500x400 mm paslanmaz çelik soyma haznesi.
- Zaman ayarlı dijital kontrol panosu.
- Uzun ömürlü ve güçlü zımpara.
- 1-2 dk patates soyma süresi.
- Paslanmaz çelik gövde.

PS.09-PS.10

- PS.10 Motor gücü:1.1kw 900 D/Dk- 380 V
- PS.09 Motor gücü:1.5kw 900 D/Dk-220 V
- 500x500 mm paslanmaz çelik soyma haznesi.
- Zaman ayarlı dijital kontrol panosu.
- Uzun ömürlü ve güçlü zımpara.
- 1-2 dk patates soyma süresi.
- Paslanmaz çelik gövde.

English

POTATO PEELERS

PS.05-PS.06

- Motor Power: 0.55 kw 900 rpm-220 V / 380 V
- Stainless steel housing dimension: 400x380 mm
- Equipped with timer and control panel.
- Removable rotating plate and housing covered with durable abrasive.
- Peeling time: 1-2 minute.
- Stainless steel body.

PS.07-PS.08

- Motor Power: 0.75 kw 900 rpm-220 V / 380 V
- Stainless steel housing dimension:500x400 mm
- Equipped with timer and control panel.
- Removable rotating plate and housing covered with durable abrasive.
- Peeling time: 1-2 minute.
- Stainless steel body.

PS.09-PS.10

- PS.10 Motor Power: 1.1kw 900 rpm 380 V
- PS.09 Motor Power: 1.5kw 900 rpm 220 V
- Stainless steel housing dimension:500x500 mm
- Equipped with timer and control panel.
- Removable rotating plate and housing covered with durable abrasive.
- Peeling time: 1-2 minute.
- Stainless steel body.

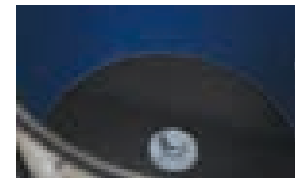

Su geçirmez touch panel kontrol
Water proof touch panel control



Hazırlik
Preparation

Tulumba ve Köfte Şekillendirme Makineleri Semolina Pasta Preparation and Meatball Shapers



Kod Code	Ürün Adı Description	Ebatlar Dimension mm			Ağırlık Weight kg	Net Net m³	Kapasite Capacity kg	Fiyatı Price Euro
		a	b	c				
TK.01	Otomatik Tulumba ve Köfte Şekillendirme Makinesi (220V) Automatic Semolina and Meatball Shapers (220V)	470x1530x1030			103	0.76	5	1.260
TK.02	Otomatik Tulumba ve Köfte Şekillendirme Makinesi (380V) Automatic Semolina and Meatball Shapers (380V)	470x1530x1030			103	0.76	5	1.155
TK.05	Otomatik Tulumba ve Köfte Şekillendirme Makinesi (220V) Automatic Semolina and Meatball Shapers (220V)	470x1530x1030			105	0.76	10	1.315
TK.06	Otomatik Tulumba ve Köfte Şekillendirme Makinesi (380V) Automatic Semolina and Meatball Shapers (380V)	470x1530x1030			105	0.76	10	1.260

Türkçe

TULUMBA VE KÖFTE ŞEKİLENDİRME MAKİNELERİ

- 0.37 kw-1400 D/Dk 220 V-380 V motor gücü.
- 6-7 dakika şekillendirme süresi.
- 4 farklı uzunlukta şekil verme imkanı.

English

SEMOLINA PASTA PREPARATION AND MEATBALL SHAPERS

- Motor power:0.37 kw 1400 rpm-220 V / 380 V
- Duration of shaping:6-7 minutes.
- 4 different shaping length option.

Lokma ve Tulumba Tatlı Makineleri Doughnut and Tulumba Dessert Machine



Kod Code	Ürün Adı Description	Ebatlar Dimension mm			Ağırlık Weight kg	Net Net m³	Kapasite Capacity lt	Fiyatı Price Euro
		a	b	c				
EMP.TK.001	Tulumba Tatlı Şekillendirme Makinesi Semolina Dessert Preparation Machine	300	500	300	24	0.05	5	1.980



Otomatik Kontrol Panelli
Automatic Control Panel

Kod Code	Ürün Adı Description	Ebatlar Dimension mm			Ağırlık Weight kg	Net Net m³	Fiyatı Price Euro
		a	b	c			
EMP.LK.001	Saray ve İzmir Lokma Makinesi - 220 V. Doughnut Machine 220 V.	300	500	300	24	0.05	1.100

Kod Code	Ürün Adı Description	Ebatlar Dimension mm			Ağırlık Weight kg	Net Net m³	Fiyatı Price Euro
		a	b	c			
EMP.LK.002	Saray ve İzmir Lokma Makinesi Tezgahı Lpg-Ng Doughnut Machine Table Lpg-Ng	1600	750	850	75	1.1	1.945
EMP.LK.003	Saray ve İzmir Lokma Makinesi Tezgahı Elektrikli 220 V Doughnut Machine Table Electrical 220 V	1600	750	850	75	1.1	2.100



EMP.TK.001 + EMP.LK.002
Tulumba Tatlı Şekillendirme
Makinesi
Semolina Dessert Preparation
Machine
Saray ve İzmir Lokma Makinesi
Tezgahı Lpg-Ng
Doughnut Machine Table Lpg-Ng



EMP.LK.001 + EMP.LK.002
Saray ve İzmir Lokma Makinesi
Doughnut Machine
Saray ve İzmir Lokma Makinesi Tezgahı Lpg-Ng
Doughnut Machine Table Lpg-Ng



Türkçe

SARAY VE İZMİR LOKMA MAKİNESİ TULUMBA VE TATLI ŞEKİLENDİRME MAKİNESİ

- 220 V. - 50 Hz Enerji.
- 7 kg hamur hazne kapasitesi.
- 25 lt pişirme kazanı.
- Kilitlenebilen tekerlekler.
- Paslanmaz çelik gövde.

Saray Lokma Makinesi dakikada 300 adet
300 pieces of doughnut per a minute
İzmir Lokma Makinesi dakikada 48 adet
48 pieces of doughnut per a minute

English

DOUGHNUT MACHINES SEMOLINA DESSERT PREPARATION MACHINE

- 220 V. - 50 Hz Energy.
- Dough capacity: 7 kg
- Cooking bowl capacity: 25 lt
- Lockable castors.
- Stainless steel body.

Lokma ve Tulumba Tatlı Makineleri
Doughnut and Tulumba Dessert Machine

2 Pişiricili / 2 Cookers

Kod Code	Ürün Adı Description	Ebatlar Dimension mm			Ağırlık Weight kg	Net Net m³	Fiyatı Price Euro
		a	b	c			
EMP.LK.006	Saray ve İzmir Lokma Makinesi Tezgahı Lpg-Ng Doughnut Machine Table Lpg-Ng	2200x750x850			105	1.4	2.350
EMP.LK.007	Saray ve İzmir Lokma Makinesi Tezgahı Elektrikli 220 V Doughnut Machine Table Electrical 220 V	2200x750x850			105	1.4	2.500



EMP.TK.001 + EMP.LK.001 + EMP.LK.002

Tulumba Tatlı Şekillendirme Makinesi
Semolina Dessert Preparation Machine
Saray ve İzmir Lokma Makinesi
Doughnut Machine

Saray ve İzmir Lokma Makinesi Tezgahı Lpg-Ng
Doughnut Machine Table Lpg-Ng



Kod Code	Ürün Adı Description	Ebatlar Dimension mm			Ağırlık Weight kg	Net Net m³	Fiyatı Price Euro
		a	b	c			
EMP.LK.004	Saray ve İzmir Lokma Makinesi Standı Doughnut Machine Stand	600x600x550			12	0.20	235

EMP.LK.001+EMP.LK.004

Saray ve İzmir Lokma Makinesi
Doughnut Machine

Saray ve İzmir Lokma Makinesi Standı
Doughnut Machine Stand

Türkçe

SARAY VE İZMİR LOKMA MAKİNESİ
TULUMBA VE TATLI ŞEKLİLENDİRME
MAKİNESİ

- 220 V. - 50 Hz Enerji.
- 7 kg hamur hazne kapasitesi.
- 25 lt pişirme kazanı.
- Kilitlenebilir tekerlekler.
- Paslanmaz çelik gövde.

Saray Lokma Makinesi dakikada 300 adet
300 pieces of doughnut per a minute

İzmir Lokma Makinesi dakikada 48 adet
48 pieces of doughnut per a minute

English

DOUGHNUT MACHINES
SEMOLINA DESSERT PREPARATION
MACHINE

- 220 V. - 50 Hz Energy.
- Dough capacity: 7 kg
- Cooking bowl capacity: 25 lt
- Lockable castors.
- Stainless steel body.

Çatal Kaşık Parlaticılar Cutlery Polisher



Kod Code	Ürün Adı Description	Ebatlar Dimension mm			Ağırlık Weight kg	Net Net m³	Kapasite Capacity lt	Fiyatı Price Euro
		a	b	c				
EMP.CKP.01	Çatal Kaşık Parlaticı Cutlery Polisher	560	550	410	50	0.12	3000	1.575

Türkçe

ÇATAL KAŞIK PARLATICI

EMP.CKP.01

- 0,60 Kw 220 V Toplam makine gücü.
- 8 W gücünde ultraviyole ampül.
- 3 Kg parlaticı ürün kapasitesi.
- 3000 Adet / Saat parlatma kapasitesi.
- Paslanmaz çelik gövde.

English

CUTLERY POLISHER

EMP.CKP.01

- Total power:0.60 Kw 220 V
- Ultraviolet lamp power : 8 W
- 3 Kg tank capacity for polisher material.
- 3000 Piece/Hour polishing capacity.
- Stainless steel body.



Kod Code	Ürün Adı Description	Ebatlar Dimension mm			Ağırlık Weight kg	Net Net m³	Kapasite Capacity lt	Fiyatı Price Euro
		a	b	c				
EMP.CKP.02	Çatal Kaşık Parlaticı Cutlery Polisher	660	650	700	82	0.3	7000	2.050

Türkçe

ÇATAL KAŞIK PARLATICI

EMP.CKP.02

- 0,80 Kw 220 V Toplam makine gücü.
- 8 W gücünde ultraviyole ampül.
- 5 Kg parlaticı ürün kapasitesi.
- 7000 Adet / Saat parlatma kapasitesi.
- Paslanmaz çelik gövde.

English

CUTLERY POLISHER

EMP.CKP.02

- Total power:0.80 Kw 220 V
- Ultraviolet lamp power : 8 W
- 5 Kg tank capacity for polisher material.
- 7000 Piece/Hour polishing capacity.
- Stainless steel body.

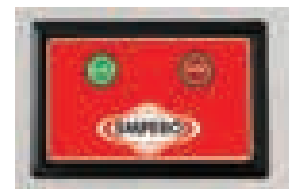

Su geçirmez touch panel kontrol
Water proof touch panel control

Bardak Kurutucu
Glass Dryer

Kod Code	Ürün Adı Description	Ebatlar Dimension mm			Ağırlık Weight kg	Net Net m³	Kapasite Capacity Bardak/Saat Glass/Hour	Fiyatı Price Euro
		a	b	c				
EMP.BPR.001	Bardak Kurutucu Glass Dryer	595x322x510			27	0.1	600-720	1.260

Türkçe

BARDAK KURUTUCU

EMP.BPR.001

- 0,37 Kw 220 V/50-60 Hz motor gücü.
- 2,62 Kw makine toplam gücü.
- 600-720 bardak/saat kapasitesi.
- 8 adet bardak parlatici püskülü.
- Sıcak hava kurutma kanalları.
- Paslanmaz çelik gövde.

English

GLASS DRYER

EMP.BPR.001

- Motor power:0,37 Kw 220 V/50-60 Hz
- 2,62 Kw total power.
- 600/720 glass/hour capacity.
- 8 pieces glass polisher tassels.
- Hot air drying.
- Stainless steel body.



Kod Code	Ürün Adı Description	Ebatlar Dimension mm			Ağırlık Weight kg	Net Net m³	Kapasite Capacity Bardak/Saat Glass/Hour	Fiyatı Price Euro
		a	b	c				
EMP.BPR.002	Bardak Kurutucu Glass Dryer	360x340x510			19,5	0.06	300-360	1.000

Türkçe

BARDAK KURUTUCU

EMP.BPR.002

- 0,37 Kw 220 V/50-60 Hz motor gücü.
- 1,49 Kw makine toplam gücü.
- 300-360 bardak/saat kapasitesi.
- 5 adet bardak parlatici püskülü.
- Sıcak hava kurutma kanalları.
- Paslanmaz çelik gövde.

English

GLASS DRYER

EMP.BPR.002

- Motor power:0,37 Kw 220 V/50-60 Hz
- 1,49 Kw total power.
- 300-360 glass/hour capacity.
- 5 pieces glass polisher tassels.
- Hot air drying.
- Stainless steel body.

Kod Code	Ürün Adı Description	Fiyatı Price Euro
Y.EMP.BPR.001.1008	Uzun Püskül / Long Tassel	14
Y.EMP.BPR.001.1009	Kısa Püskül / Short Tassel	11

Ekmek Dilimle Makinesi Bread Slicers



Kod Code	Ürün Adı Description	Ebatlar Dimension mm			Ağırlık Weight kg	Net Net m³	Kapasite Capacity Dilim/Saat Slice/Hour	Fiyatı Price Euro
		a	b	c				
EMP.3003	Baget Ekmek Dilimleyici Baget Bread Slicer	400	545	1001	30	0.22	8000	1.155

Türkçe

BAGET EKMEK DİLİMLEYİCİ

EMP.3003

- 0,60 Kw 220 V motor gücü.
- 10-80 mm dilim kalınlığı.
- 8000 dilim/saat kapasitesi.
- Paslanmaz çelik gövde.

English

BAGET BREAD SLICER

EMP.3003

- Motor power:0.60 Kw 220 V
- 10-80 mm slice thickness.
- 8000 slice /hour capacity.
- Stainless steel body.



Simit & Sandviç Kesme Makinesi Pretzel & Sandwich Slicer



Kod Code	Ürün Adı Description	Ebatlar Dimension mm			Ağırlık Weight kg	Net Net m³	Fiyatı Price Euro
		a	b	c			
EMP.3005	Simit & Sandviç Kesme Makinesi Pretzel & Sandwich Slicer	490	300	245	20	0.04	1.300

Türkçe

SİMİT & SANDVIÇ KESME MAKİNESİ

EMP.3005

- 0,12 Kw 220 V motor gücü.
- 210 mm kesme uzunluğu.
- 140 mm kesme genişliği.
- 20-55 mm kesme yüksekliği.
- Paslanmaz çelik gövde.

English

PRETZEL & SANDWICH SLICER

EMP.3005

- Motor power:0.12 Kw 220 V
- 210 mm slicing length.
- 140 mm slicing width.
- 20-55 mm slicing height.
- Stainless steel body.



Ekmek Dilimle Makineleri
Bread Slicers

Kod Code	Ürün Adı Description	Ebatlar Dimension mm			Ağırlık Weight kg	Dilim Kalınlığı Slice Thickness mm	Fiyatı Price Euro
		a	b	c			
EMP.3001-10	Ekmek Dilimleme Makinesi Bread Slicer	700x700x1100			132	10	1.385
EMP.3001-13	Ekmek Dilimleme Makinesi Bread Slicer	700x700x1100			132	13	1.385
EMP.3001-16	Ekmek Dilimleme Makinesi Bread Slicer	700x700x1100			132	16	1.385
EMP.3002	Trabzon Ekmek Dilimleme Makinesi Bread Slicer	700x800x1100			132	20	1.450

Türkçe

EKMEK DİLİMLEME MAKİNESİ

EMP.3001

- 0.37 kw - 220 V motor gücü.
- 500 mm ekmek uzunluğu.
- 140 mm ekmek yüksekliği.
- 30 adet bıçak.
- Paslanmaz çelik bıçaklar.

EMP.3002

- 0.37 kw - 220 V motor gücü.
- 500 mm ekmek uzunluğu.
- 170 mm ekmek yüksekliği.
- 24 adet bıçak.
- Paslanmaz çelik bıçaklar.

English

BREAD SLICER

EMP.3001

- Motor Power:0.37 kw - 220 V
- Bread length: 500 mm
- Bread height: 140 mm
- Quantity of blades:30
- Stainless steel blades.

EMP.3002

- Motor Power:0.37 kw - 220 V
- Bread length: 500 mm
- Bread height: 170 mm
- Quantity of blades: 24
- Stainless steel blades.



Kod Code	Ürün Adı Description	Ebatlar Dimension mm			Ağırlık Weight kg	Dilim Kalınlığı Slice Thickness mm	Fiyatı Price Euro
		a	b	c			
EMP.3004-10	Setüstü Ekmek Dilimleme Makinesi Bench Top Bread Slicer	650x650x700			120	10	1.525
EMP.3004-13	Setüstü Ekmek Dilimleme Makinesi Bench Top Bread Slicer	650x650x700			120	13	1.525
EMP.3004-16	Setüstü Ekmek Dilimleme Makinesi Bench Top Bread Slicer	650x650x700			120	16	1.525

Türkçe

EKMEK DİLİMLEME MAKİNESİ

EMP.3004

- 0.37 kw - 220 V motor gücü.
- 480 mm ekmek uzunluğu.
- 130 mm ekmek yüksekliği.
- 30 adet bıçak.
- Paslanmaz çelik bıçaklar.

English

BREAD SLICER

EMP.3004

- Motor Power:0.37 kw - 220 V
- Bread length: 480 mm
- Bread height: 130 mm
- Quantity of blades: 30
- Stainless steel blades.

Sıcaklık Dolabı
Hot Cupboard



İzolasyonsuz / Non insulated

Kod Code	Ürün Adı Description	Ebatlar Dimension mm			Güç Power kw	Fiyatı Price Euro
		a	b	c		
EMP.IDP.7120	Sıcaklık Dolabı - İzolasyonsuz Hot Cupboard - Non Insulated	1200x700x850			1.4	910
EMP.IDP.7140	Sıcaklık Dolabı - İzolasyonsuz Hot Cupboard - Non Insulated	1400x700x850			1.6	1.050
EMP.IDP.7160	Sıcaklık Dolabı - İzolasyonsuz Hot Cupboard - Non Insulated	1600x700x850			1.8	1.150
EMP.IDP.7180	Sıcaklık Dolabı - İzolasyonsuz Hot Cupboard - Non Insulated	1800x700x850			2	1.250
EMP.IDP.7200	Sıcaklık Dolabı - İzolasyonsuz Hot Cupboard - Non Insulated	2000x700x850			2.2	1.400

İzolasyonlu / Insulated

Kod Code	Ürün Adı Description	Ebatlar Dimension mm			Güç Power kw	Fiyatı Price Euro
		a	b	c		
EMP.IDP.7120-I	Sıcaklık Dolabı - İzolasyonlu Hot Cupboard - Insulated	1200x700x850			1.4	1.050
EMP.IDP.7140-I	Sıcaklık Dolabı - İzolasyonlu Hot Cupboard - Insulated	1400x700x850			1.6	1.200
EMP.IDP.7160-I	Sıcaklık Dolabı - İzolasyonlu Hot Cupboard - Insulated	1600x700x850			1.8	1.300
EMP.IDP.7180-I	Sıcaklık Dolabı - İzolasyonlu Hot Cupboard - Insulated	1800x700x850			2	1.450
EMP.IDP.7200-I	Sıcaklık Dolabı - İzolasyonlu Hot Cupboard - Insulated	2000x700x850			2.2	1.600

Türkçe

SICAKLIK DOLABI

- 0°C - 90°C çalışma ısısı.
- Paslanmaz çelik gövde.

English

HOT CUPBOARD

- 0°C - 90°C operating temperature.
- Stainless steel body.

Sıcak Banket Arabaları
Hot Banquet Trolleys

Kod Code	Ürün Adı Description	Ebatlar Dimension mm			Ağırlık Weight kg	Net Net m³	Güç Power kw	Kapasite Capacity	Fiyatı Price Euro
		a	b	c					
EMP.BQ1	Sıcak Banket Arabası Hot Banquet Trolley	717	888	1803	111	1.21	1.7	11xGN2/1	1.760



Kod Code	Ürün Adı Description	Ebatlar Dimension mm			Ağırlık Weight kg	Net Net m³	Güç Power kw	Kapasite Capacity	Fiyatı Price Euro
		a	b	c					
EMP.BQ2	Sıcak Banket Arabası Hot Banquet Trolley	1352	888	1803	200	2.17	3.4	2x(11xGN2/1)	2.930



Kod Code	Ürün Adı Description	Ebatlar Dimension mm			Ağırlık Weight kg	Net Net m³	Güç Power kw	Kapasite Capacity	Fiyatı Price Euro
		a	b	c					
EMP.BQ3	Sıcak Banket Arabası Hot Banquet Trolley	717	888	1245	60	0.79	1.7	6xGN2/1	1.365



Kod Code	Ürün Adı Description	Ebatlar Dimension mm			Ağırlık Weight kg	Net Net m³	Güç Power kw	Kapasite Capacity	Fiyatı Price Euro
		a	b	c					
EMP.BQ4	Sıcak Banket Arabası Hot Banquet Trolley	582	768	1684	85	0.75	1.7	15xGN1/1	1.420

Türkçe

SICAK BANKET ARABALARI

- 0°C - 70°C çalışma ısısı.
- 220 V çalışma voltajı.
- Dijital termostat kontrol ünitesi.
- İç ısı göstergesi.
- Nemlendirme.
- Çıkarılabilir kaset ve kolay temizleme.
- Manyetik kilit.
- Kilitlebilir tekerlekler ile sabitleyebilme özelliği.
- 40 kg/m3 yoğunluk poliüretan izolasyon.
- Pres baskı iç tepsi kızakları.
- Paslanmaz çelik gövde.

English

HOT BANQUET TROLLEYS

- 0°C - 70°C operating temperature.
- Operating voltage : 220 V
- Digital thermostat control unit.
- Interior heating indicator.
- Humidification system.
- Removable drawer and easy to clean.
- Magnetic locker.
- Lockable castors provide stabilizing.
- Isolation type:40 kg/m3 density polyurethane isolation.
- Pressed interior tray slides.
- Stainless steel body.



Soğuk Banket Arabaları Cold Banquet Trolleys



Kod Code	Ürün Adı Description	Ebatlar Dimension mm			Ağırlık Weight kg	Net Net m³	Güç Power kw	Kapasite Capacity	Fiyatı Price Euro
		a	b	c					
EMP.BQ1-S	Soğuk Banket Arabası Cold Banquet Trolley	720	885	1830	131	1.16	0.35	11xGN2/1	2.260



Kod Code	Ürün Adı Description	Ebatlar Dimension mm			Ağırlık Weight kg	Net Net m³	Güç Power kw	Kapasite Capacity	Fiyatı Price Euro
		a	b	c					
EMP.BQ2-S	Soğuk Banket Arabası Cold Banquet Trolley	1360	885	1830	240	2.20	0.7	2x(11xGN2/1)	3.780



Kod Code	Ürün Adı Description	Ebatlar Dimension mm			Ağırlık Weight kg	Net Net m³	Güç Power kw	Kapasite Capacity	Fiyatı Price Euro
		a	b	c					
EMP.BQ3-S	Soğuk Banket Arabası Cold Banquet Trolley	720	885	1250	80	0.79	0.35	6xGN2/1	1.835



Kod Code	Ürün Adı Description	Ebatlar Dimension mm			Ağırlık Weight kg	Net Net m³	Güç Power kw	Kapasite Capacity	Fiyatı Price Euro
		a	b	c					
EMP.BQ4-S	Soğuk Banket Arabası Cold Banquet Trolley	505	775	1830	105	0.71	0.35	15xGN1/1	1.890



Türkçe

SOĞUK BANKET ARABASI

- Çalışma aralığı: +0 °C, + 5 °C (tropikal 43° C)
- 220 V-230 V -1 +N -50 60 Hz elektrik gücü.
- "CFC Free", R-134 A soğutucu gaz.
- 220 V çalışma voltajı.
- Dijital termostat kontrol ünitesi.
- Miknatıslı kilit.
- Kilitlenebilir tekerlekler ile sabitleyebilme özelliği.
- 40 kg/m3 yoğunluk poliüretan izolasyon.
- Pres baskı iç tepsi kızakları.
- Paslanmaz çelik gövde.

English

COLD BANQUET TROLLEY

- Working temperature; 0° C, + 5° C (at ambient temp.43° C)
- 220 V-230 V -1 +N -50 60 Hz electrical power.
- "CFC Free", R-134 A refrigerant gas.
- Operating voltage : 220 V
- Digital thermostat control unit.
- Magnetic locker.
- Lockable castors provide stabilizing.
- Isolation type:40 kg/m3 density polyurathane isolation.
- Pressed interior tray slides.
- Stainless steel body.

**R-290 Soğutucu Gaz Tipi için %3 fiyat farkı ekleyiniz.
Please add %3 price difference for R-290 refrigerant gas.**

Çekmeceli Isıtma Ünitesi
Drawer Warmer

Kod Code	Ürün Adı Description	Ebatlar Dimension mm			Ağırlık Weight kg	Net Net m³	Güç Power kw	Fiyatı Price Euro
		a	b	c				
EMP.EI.01	Bir Çekmeceli Isıtma Ünitesi One Drawer Heating Unit	825	630	405	40	0.2	2	750



Kod Code	Ürün Adı Description	Ebatlar Dimension mm			Ağırlık Weight kg	Net Net m³	Güç Power kw	Fiyatı Price Euro
		a	b	c				
EMP.EI.02	İki Çekmeceli Isıtma Ünitesi Two Drawer Heating Unit	825	630	680	73	0.3	4	1.250



Kod Code	Ürün Adı Description	Ebatlar Dimension mm			Ağırlık Weight kg	Net Net m³	Güç Power kw	Fiyatı Price Euro
		a	b	c				
EMP.EI.03	Üç Çekmeceli Isıtma Ünitesi Three Drawer Heating Unit	825	630	960	106	0.9	6	1.750

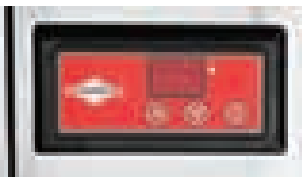

Türkçe

ÇEKMECELİ ISITMA ÜNİTESİ

- 0°C - 90°C çalışma ısısı.
- 220 V çalışma voltajı.
- Her çekmece için ayrı ayrı kontrol edilebilir termostatik kontrol.
- 40 kg/m3 yoğunluk poliüretan izolasyon.
- Dayanıklı çekmece iç kızakları.
- Paslanmaz çelik gövde.
- 1/1 Gn Küvet Kapasitesi.

English

DRAWER WARMER

- 0°C - 90°C operating temperature.
- Operating voltage : 220 V
- Each drawer has separate thermostat control.
- Isolation type:40 kg/m3 density polyurethane isolation.
- Heavy duty drawer slides.
- Stainless steel body.
- 1/1 Gn Capacity.

Bıçak Sterilizatörü
Knife Sterilizer



Kod Code	Ürün Adı Description	Ebatlar Dimension mm			Ağırlık Weight kg	Net Net m³	Güç Power W	Kapasite Capacity Adet/Pieces	Fiyatı Price Euro
		a	b	c					
EMP.BST.001	Bıçak Sterilizatörü Knife Sterilizer	552x131x620			9	0.05	0.1	10	170
EMP.BST.002	Bıçak Sterilizatörü Knife Sterilizer	1022x131x620			13	0.09	0.2	20	250

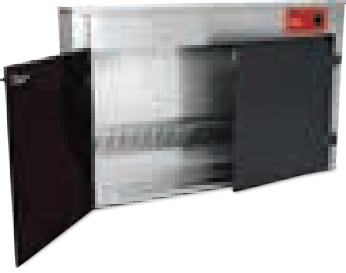

Türkçe

BIÇAK STERİLİZATÖRÜ

- 0-120 dakika zaman ayarı.
- Renkli pleksiglas kapak.
- Paslanmaz çelik gövde.

English

KNIFE STERILIZER

- Timer:0-120 minutes.
- Plexiglass doors.
- Stainless steel body.

Dizden Kumandalı El Yıkama Eyesi
Knee Operating Handwash Basin

Kod Code	Ürün Adı Description	Ebatlar Dimension mm			Ağırlık Weight kg	Net Net m³	Fiyatı Price Euro
		a	b	c			
EMP.DKE.001	Dizden Kumanda El Yıkama Eyesi Knee Operating Handwash Basin	505x450x220			7	0.05	200
NEW EMP.DKE.002	Dizden Kumanda El Yıkama Eyesi Knee Operating Handwash Basin	400x400x220			7	0.04	180

Türkçe

DİZDEN KUMANDALI EL
YIKAMA EVYESİ

- 15 saniye boyunca su akıtma özelliği.
- Duvara monte edilebilir.
- Paslanmaz çelik gövde.

English

KNEE OPERATING
HANDWASH BASIN

- 15 seconds water flow is available in every operation.
- Wall-mounted option.
- Stainless steel body.

Paspas Yıkama Eyesi
Janitorial Sink Unit

Kod Code	Ürün Adı Description	Ebatlar Dimension mm	Eyve Sink mm	Fiyatı Price Euro
EMP.PE.5060	Paspas Yıkama Eyesi Janitorial Sink Unit	500x600x900	400x400x250	375
EMP.PE.5070	Paspas Yıkama Eyesi Janitorial Sink Unit	500x700x900	400x400x250	420

Kumpir Fırınları Potato Baking Ovens



Elektrikli Kumpir Fırını - Üç Çekmeceli
Electrical Potato Baking Ovens - Three Drawers



Gazlı Kumpir Fırını - Üç Çekmeceli
Gas Potato Baking Ovens - Three Drawers

Kod Code	Ürün Adı Description	Ebatlar Dimension mm			Ağırlık Weight kg	Net Net m³	Güç Power Kw	Kapasite Capacity Adet/Saat Pieces/Hour	Fiyatı Price Euro
		a	b	c					
EMP.KFE.020	Elektrikli Kumpir Fırını - İki Çekmeceli Electrical Potato Baking Ovens - Two Drawers	500x700x750			45	0.26	3	24-30	1.075
EMP.KFE.030	Elektrikli Kumpir Fırını - Üç Çekmeceli Electrical Potato Baking Ovens - Three Drawers	500x700x980			60	0.34	4.5	36-45	1.200
EMP.KFG.020	Gazlı Kumpir Fırını - İki Çekmeceli Gas Potato Baking Ovens - Two Drawers	500x700x950			55	0.33	4.9	24-30	1.075
EMP.KFG.030	Gazlı Kumpir Fırını - Üç Çekmeceli Gas Potato Baking Ovens - Three Drawers	500x700x1200			73	0.42	4.9	36-45	1.200

Türkçe

ELEKTRİKLİ KUMPIR FIRINI

EMP.KFE.020 - EMP.KFE.030

- EMP.KFE.020 için; 3 Kw 380V - 50 Hz güç.
- EMP.KFE.030 için; 4.5 Kw 380V - 50 Hz güç.
- Her çekmece için ayrı rezistans.
- Çift izolasyonlu gövde.
- Termostat kontrollü.
- Paslanmaz çelik çekmeceler.

GAZLI KUMPIR FIRINI

EMP.KFG.020 - EMP.KFG.030

- LPG ve NG ile çalışabilme özelliği.
- Her çekmece için ayrı brülör.
- Çift izolasyonlu gövde.
- Emniyet ventili ve piezo çakmak ile kontrol.
- Paslanmaz çelik çekmeceler.

English

ELECTRICAL POTATO BAKING OVENS

EMP.KFE.020 - EMP.KFE.030

- EMP.KFE.020 power; 3 Kw 380V - 50 Hz
- EMP.KFE.030 power; 4.5 Kw 380V - 50 Hz
- Separated resistance in each drawer.
- Double insulated body.
- Thermostat controlled.
- Stainless steel drawers.

GAS POTATO BAKING OVENS

EMP.KFG.020 - EMP.KFG.030

- LPG or Naturel gas.
- Separated burner in each drawer.
- Double insulated body.
- Piezoelectric ignition system and safety valve.
- Stainless steel drawers.

Profesyonel Duvar Tip Izgara
Professional Wall Type Grill

EMP.PRG.01



Kod Code	Ürün Adı Description	Ebatlar Dimension mm			Ağırlık Weight kg	Net Net m ³	Fiyatı Price Euro
		a	b	c			
EMP.PRG.01	Profesyonel Duvar Tipi Izgara Professional Wall Type Grill	1600x750x2350			455	2.82	3.360
EMP.PRG.02	Profesyonel Duvar Tipi Izgara Professional Wall Type Grill	2150x750x2350			600	3.79	4.300

Türkçe

PROFESYONEL DUVAR TİPİ IZGARA

EMP.PRG.01

- 400x500 mm kömür yakma haznesi.
- 2 adet yüksekliği ayarlanabilir 510x530 mm kömür haznesi.
- 20 cm paslanmaz çelik ön çalışma tablası.
- Ön yüzü çift cidarlı monoblok davlumbaz.
- Devrilir kömür saklama haznesi.
- Kül toplama çekmeceleri.
- Yanma işlemini hızlandıran ayarlanabilir hava penceresi.
- Ayarlanabilir havalandırma flapları.
- Dekoratif elektrostatik boyalı gövde.

EMP.PRG.02

- 400x500 mm kömür yakma haznesi.
- 3 adet yüksekliği ayarlanabilir 510x530 mm kömür haznesi.
- 20 cm paslanmaz çelik ön çalışma tablası.
- Ön yüzü çift cidarlı monoblok davlumbaz.
- Devrilir kömür saklama haznesi.
- Kül toplama çekmeceleri.
- Yanma işlemini hızlandıran ayarlanabilir hava penceresi.
- Ayarlanabilir havalandırma flapları.
- Dekoratif elektrostatik boyalı gövde.

English

PROFESSIONAL WALL TYPE GRILL

EMP.PRG.01

- 400x500 mm charcoal reservoir.
- Grill with two adjustable charcoal trays (510x530 mm).
- 20 cm stainless steel front worktop.
- Monoblock hood with double jacket on front surface.
- Tilting drawer for charcoal storage.
- Ash drawer.
- Adjustable air passage provides quick burning.
- Adjustable air circulating flaps.
- Decorative electrostatics dyed body.

EMP.PRG.02

- 400x500 mm charcoal reservoir.
- Grill with three adjustable charcoal trays (510x530 mm).
- 20 cm stainless steel front worktop.
- Monoblock hood with double jacket on front surface.
- Tilting drawer for charcoal storage.
- Ash drawer.
- Adjustable air passage provides quick burning.
- Adjustable air circulating flaps.
- Decorative electrostatics dyed body.



Tabak Kapatma Makinesi Meal Seal Machine



Kod Code	Ürün Adı Description	Ebatlar Dimension mm			Ağırlık Weight kg	Net Net m³	Güç Power Kw	Fiyatı Price Euro
		a	b	c				
EMP.TKM.01	Tabak Kapatma Makinesi Meal Seal Machine	320x650x310			21	0.06	1	1.260
EMP.TKM.01-CM	Standart Dışı Kalıp Fiyat Farkı Custom Made Mold Price Difference							370

Standart Kalıp Standard Mold

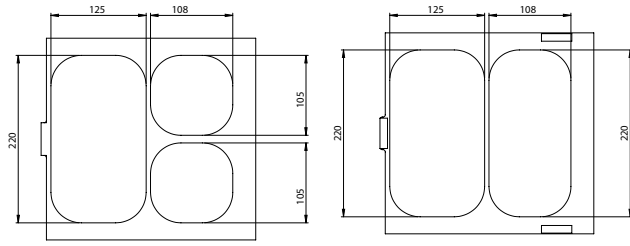

Türkçe

TABAK KAPATMA MAKİNESİ

- 230 V. 50 Hz elektrik bağlantısı.
- 270x250 mm mühürleme ebadı.
- 200 mm film kalınlığı.
- Maksimum 245 mm film genişliği.
- Paslanmaz çelik gövde.

English

MEAL SEAL MACHINE

- 230 V. 50 Hz electric connection.
- Seal surface: 270x250 mm
- Roll thickness of the film: 200 mm
- Film width: 245 mm max.
- Stainless steel body.

Streç Makinesi Stretching Machine



Kod Code	Ürün Adı Description	Ebatlar Dimension mm			Ağırlık Weight kg	Net Net m³	Güç Power Kw	Fiyatı Price Euro
		a	b	c				
EMP.SCM.01	Streç Makinesi Stretching Machine	555x440x240			7	0.07	0.17	180

Türkçe

STREÇ MAKİNESİ

- 220 V. 50-60 Hz elektrik bağlantısı.
- Filmin yabancı maddelerden korunmasını sağlayan koruma.
- 400 mm film boyu.
- Maksimum 90 °C ısıtıcı plaka sıcaklığı.
- Maksimum 150 °C kesici sıcaklığı.
- Paslanmaz çelik gövde.

English

STRETCHING MACHINE

- 220 V. 50-60 Hz electric connection.
- Top protector in order to provide damage on film.
- 400 mm film length.
- Maximum 90°C heating plate temperature.
- Maximum 150°C cutter temperature.
- Stainless steel body.

Vakum Makineleri
Vacuum Machines

Kod Code	Ürün Adı Description	Ebatlar Dimension mm			Ağırlık Weight kg	Net Net m³	Güç Power Kw	Fiyatı Price Euro
		a	b	c				
EMP.VCM.01	Vakum Makinesi Vacuum Machine	360	495	445	36	0.05	0.4	1.735

Türkçe

VAKUM MAKİNELERİ

EMP.VCM.01

- 220 V, 50 Hz elektrik bağlantısı.
- İç Hazne: 280x385x50 mm
- Yapıştırma Ağızı: 250 mm
- 260x8 mm mühürleme ebadı.
- 10 m³/h pompa kapasitesi.
- Şeffaf üst kapak kapasitesi.
- Otomatik kontrol.
- Paslanmaz çelik gövde.

English

VACUUM MACHINES

EMP.VCM.01

- 220 V, 50 Hz electric connection.
- Interior Reservoir: 280x385x50 mm
- Vacuuming Area : 250 mm
- Seal surface: 260x8 mm
- Pump capacity: 10m³/h
- Translucent top cover.
- Automatic control.
- Stainless steel body.



Kod Code	Ürün Adı Description	Ebatlar Dimension mm			Ağırlık Weight kg	Net Net m³	Güç Power Kw	Fiyatı Price Euro
		a	b	c				
EMP.VCM.02	Vakum Makinesi Vacuum Machine	550	575	560	68	0.13	0.9	3.000

Türkçe

VAKUM MAKİNELERİ

EMP.VCM.02

- 220 V, 50 Hz elektrik bağlantısı.
- İç Hazne: 460x450x170 mm
- Yapıştırma Ağızı: 430 mm
- 430x8 mm mühürleme ebadı.
- 20 m³/h pompa kapasitesi.
- Şeffaf üst kapak kapasitesi.
- Otomatik kontrol.
- Paslanmaz çelik gövde.

English

VACUUM MACHINES

EMP.VCM.02

- 220 V, 50 Hz electric connection.
- Interior Reservoir: 460x450x170 mm
- Vacuuming Area : 430 mm
- Seal surface: 430x8 mm.
- Pump capacity: 20 m³/h.
- Translucent top cover.
- Automatic control.
- Stainless steel body.



**Sıvıların vakumlanması mümkün değildir.
Does not operate in purpose of vacuuming liquids.**

Piliç Kızartma Makineleri (Elektrikli)
Electrical Chicken Rotisserie



Kod Code	Ürün Adı Description	Ebatlar Dimension mm			Ağırlık Weight kg	Net Net m³	Güç Power kw	Kapasite Capacity adet-pieces	Fiyatı Price Euro
		a	b	c					
EMP.3EE	Piliç Kızartma Makinesi - Elektrikli Electrical Chicken Rotisserie	1098x480x820			80	0.44	9.9	18	2.250
EMP.5EE	Piliç Kızartma Makinesi - Elektrikli Electrical Chicken Rotisserie	1098x480x1170			104	0.62	16.5	30	2.875
EMP.8EE	Piliç Kızartma Makinesi - Elektrikli Electrical Chicken Rotisserie	1098x480x2020			183	1.07	26.4	48	3.875

Türkçe

PİLİÇ KIZARTMA MAKİNELERİ - ELEKTRİKLİ

- Pişirme tipi elektrikli olup, her rezistans ayrı ayrı kontrol edilebilir.
- Kapak camları temperlidir.
- Şiş ve cam kapak tutma kulpları ısıya dayanıklı bakalitir.
- Elektrik tesisatı yüksek ısıya dayanıklıdır.
- Çelik dişli sistemi sessiz bir çalışma imkanı sağlar.
- Paslanmaz çelik gövde.
- Bakımı ve temizliği kolaydır.
- Her şiş 6 piliç alır.

English

ELECTRICAL CHICKEN ROTISSERIE

- Roasting type operates electrically and each resistance may controlled separately.
- Heat resistant tempered glass doors.
- Spear and door handles are made of heat resistant bakelite.
- Steel gear system provides quiet operation.
- Electric system is resistant to high temperatures.
- Stainless steel body.
- Provides simple maintain and easy cleaning.
- Each spear takes 6 chicken.





Piliç Kızartma Makineleri (Gazlı) Gas Chicken Rotisserie



Kod Code	Ürün Adı Description	Ebatlar Dimension mm			Ağırlık Weight kg	Net Net m ³	Güç Power kw	Kapasite Capacity adet-pieces	Fiyatı Price Euro
		a	b	c					
EMP.3EG	Piliç Kızartma Makinesi - Gazlı Gas Chicken Rotisserie	1098	480	820	86	0.44	12	18	2.125
EMP.5EG	Piliç Kızartma Makinesi - Gazlı Gas Chicken Rotisserie	1098	480	1170	114	0.62	30	30	2.750
EMP.8EG	Piliç Kızartma Makinesi - Gazlı Gas Chicken Rotisserie	1098	480	2020	193	1.07	48	48	3.750

Türkçe

PİLİÇ KIZARTMA MAKİNELERİ - GAZLI

- Lpg ve doğalgaza uyumludur.
- Kumanda muslukları emniyet ventillidir.
- Pişirme tipi radyanlı olup, her radyan ayrı ayrı kontrol edilebilir.
- Kapak camları temperlidir.
- Çelik dişli sistemi sessiz bir çalışma imkanı sağlar.
- Şiş ve cam kapak tutma kulpları ısıya dayanıklı bakalitir.
- Elektrik tesisatı yüksek ısıya dayanıklıdır.
- Paslanmaz çelik gövde.
- Bakımı ve temizliği kolaydır.
- Her şiş 6 piliç alır

English

GAS CHICKEN ROTISSERIE

- LPG or NG.
- Safety valve.
- Operates by radiant and each radiant can be controlled separately.
- Heat resistant tempered glass doors.
- Steel gear system provides quiet operation.
- Spear and door handles are made of heat resistant bakelite.
- Electrical fitting is durable to high temperatures.
- Stainless steel body.
- Easy cleaning.
- Each spear takes 6 chicken.



Plus Piliç Kızartma Makineleri Plus Chicken Rotisserie



Kod Code	Ürün Adı Description	Ebatlar Dimension mm			Ağırlık Weight kg	Net Net m³	Güç Power kw	Kapasite Capacity adet-pieces	Fiyatı Price Euro
		a	b	c					
EMP.PLS.5EE	Plus Piliç Kızartma Makinesi - Elektrikli Plus Electrical Chicken Rotisserie	1100	480	2030	193	1.07	16.5	30	3.875
EMP.PLS.5EG	Plus Piliç Kızartma Makinesi - Gazlı Plus Gas Chicken Rotisserie	1100	480	2030	193	1.07	24	30	3.750

Türkçe

PLUS PİLİÇ KIZARTMA MAKİNELERİ

- Pişirme tipi elektrikli olup, her rezistans ayrı ayrı kontrol edilebilir.
- Kapak camları temperlidir.
- Şiş ve cam kapak tutma kulpları ısıya dayanıklı bakalitir.
- Elektrik tesisatı yüksek ısıya dayanıklıdır.
- Çelik dişli sistemi sessiz bir çalışma imkanı sağlar.
- Paslanmaz çelik gövde.
- Bakımı ve temizliği kolaydır.
- Her şiş 6 piliç alır.

English

PLUS CHICKEN ROTISSERIE

- Roasting type operates electrically and each resistance may be controlled separately.
- Heat resistant tempered glass doors.
- Spear and door handles are made of heat resistant bakelite.
- Steel gear system provides quiet operation.
- Electric system is resistant to high temperatures.
- Stainless steel body.
- Provides simple maintain and easy cleaning.
- Each spear takes 6 chicken.



Servis Arabaları
Service Trolleys

Kod Code	Ürün Adı Description	Ebatlar Dimension mm	Fiyatı Price Euro
EMP.2.SV.02	Servis-İki Katlı Service Trolley, 2 Tiers	550x860x900	220

Pres baskılı tabla / Pressed stainless steel table



Kod Code	Ürün Adı Description	Ebatlar Dimension mm	Fiyatı Price Euro
EMP.2.SV.03	Servis-Üç Katlı Service Trolley, 3 Tiers	550x860x900	275

Pres baskılı tabla / Pressed stainless steel table

Plastik Mama Sandalyesi
Plastic Baby Feeding Chair

Kod Code	Ürün Adı Description	Ebatlar Dimension mm	Fiyatı Price Euro
EMP.MS.01	Plastik Mama Sandalyesi Plastic Baby Feeding Chair	600x600x750	190

Tepsi fiyata dahildir. / Tray is included

Plastik Servis Arabaları
Plastic Service Trolleys

NEW

Kod Code	Ürün Adı Description	Ebatlar Dimension mm	Fiyatı Price Euro
EMP.PSV.02	Plastik Servis Arabası - İki Katlı Plastic Service Trolley, 2 Tiers	520x960x1070	88



Kod Code	Ürün Adı Description	Ebatlar Dimension mm	Fiyatı Price Euro
EMP.PSV.03	Plastik Servis Arabası - Üç Katlı Plastic Service Trolley, 3 Tiers	520x960x1070	105



Kod Code	Ürün Adı Description	Ebatlar Dimension mm	Fiyatı Price Euro
EMP.PSV.03-K	Plastik Servis Arabası - İki Katlı Monoblok Plastic Service Trolley, 2 Tiers Monoblock	520x960x1070	125



Kod Code	Ürün Adı Description	Ebatlar Dimension mm	Fiyatı Price Euro
EMP.CK.01-P	Çöp Aparatı - Plastik Trash Apparatus - Plastic	330x225x560	12
EMP.CK.02-P	Kaşık Aparatı - Plastik Spoon Apparatus - Plastic	330x230x175	6
EMP.YK.01	Monoblok Kapaklar Monoblock Covers		20





İş'in Mutfağı / Kitchen of Business





Kafeterya
Cafe



İçin Mutfak / Kitchen of Business

empero@empero.com.tr





- * Portakal Sıkma Makinesi (Otomatik) / Orange Juicer (Automatic)
- * Şerbet ve Ayran Makinesi / Juicer and Ayran Maker
- * Köpüklü Ayran Makinesi / Sparkling Ayran Maker
- * Capuccino Espresso Makineleri / Cappucino Espresso Machines
- * Otomatik Capuccino Espresso Makineleri / Automatic Cappucino Espresso Machines
- * Demlikli Çay Otomatı / Tea Maker With Pot
- * Çay ve Su Otomatları / Tea Maker & Hot Water Dispenser
- * Çikolata Şelalesi / Chocolate Fountain
- * Sıcak Teşhir Ünitesi (Halojen Isıtıcı) / Hot Display Unit (Halogen Lamp)
- * Sıcak Teşhir Ünitesi (Halojen Isıtıcı) / Hot Display Unit (Halogen Lamp)
- * Döner Ocakları (Gazlı) / Shawarma Machines, Gas
- * Alttan Motorlu Camlı Döner Ocakları (Elektrikli - Gazlı) / Robax Glass Electrical - Gas Shawarma Machines (Motor at bottom)
- * Tost Makineleri (Elektrikli) / Toaster (Electrical)
- * Konveyörlü Ekmek Kızartma Makinesi / Conveyor Toaster
- * Krep ve Waffle Makinesi / Crepe & Waffel Maker
- * Elektrikli ve Gazlı Salamander Izgara / Electric & Gas Salamander Grill

Portakal Sıkma Makinesi (Otomatik)
Orange Juicer (Automatic)



Kod Code	Ürün Adı Description	Ebatlar Dimension mm			Ağırlık Weight kg	Net Net m³	Kapasite Capacity adet/dk-pcs/min	Fiyatı Price Euro
		a	b	c				
EMP.ORG.50	Otomatik Portakal Sıkma Makinesi Automatic Orange Juicer	580x600x830			81	0.28	25	2.365
EMP.ORG.51	Alt Stand Bottom Stand	600x630x880			31	0.33		575

Türkçe

OTOMATİK PORTAKAL SIKMA MAKİNESİ

ORG.50

- 0.25 kw 1400 D/Dk 220-240 V 50-60 Hz. sıkıcı motor gücü.
- 0.18 kw 1400 D/Dk 220-240 V 50-60 Hz. Üst hazne motor gücü.
- Güvenlik sensörü.
- Tek seferde 18 kg yükleme kapasitesi.
- 60-85 mm portakal çapı.
- Paslanmaz çelik alt stand.

English

ORANGE JUICER (AUTOMATIC)

ORG.50

- Squeezer motor power:0.25 kw 1400 rpm 220-240 V 50-60 Hz
- Top reservoir motor power:0.18 kw 1400 D/Dk 220-240 V 50-60 Hz
- Safety switch .
- Loading capacity:18 kg/time.
- Orange diameter: 60-85mm
- Stainless steel bottom stand.

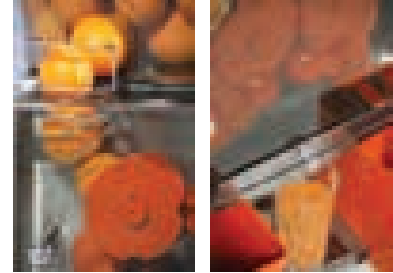

Plastik hazne
fiyata dahil değildir.

Plastic container
is not included
is not in the price.

Şerbet ve Ayran Makinesi
Juicer and Ayran Maker

Kod Code	Ürün Adı Description	Ebatlar Dimension mm			Ağırlık Weight kg	Net Net m ³	Kapasite Capacity lt	Fiyatı Price Euro
		a	b	c				
EMP.SY.19	Şerbet ve Ayran Makinesi Juicer and Ayran Maker	320x400x700			20	0.09	19	850

Türkçe

ŞERBET VE AYRAN MAKİNESİ

- 220 V. 50 Hz. çalışma gücü.
- r134A Soğutucu gaz.
- Tabandan soğutma sistemi ile içeceği son damlasına kadar eşit olarak soğutma.
- Dijital termostat ve soğutma sistemi sayesinde %15 enerji tasarrufu.
- Dijital termostat kontrol.
- +3 ile +10 derece arasında sıcaklık.
- Su sızması ve motora su kaçma riski ortadan kaldıran manyetik karıştırma sistemi.
- Geniş musluk hortumu.
- Düşük çalışma ses seviyesi.
- Hazne kapağının düz formu sayesinde bardaklık olarak kullanabilme imkanı.
- İçecek ile temas eden tüm parçalar kolaylık çıkarılabilir ve temizlenebilir.

English

JUICE and AYRAN MAKER

- 220 V. 50 Hz operating power.
- R134A Refrigerant gas.
- Floor-cooling system with cools evenly until the last drop of drink.
- The digital thermostat and cooling system provides a 15% energy savings.
- It shows the current temperature of the drink with digital thermostat.
- Beverage temperature can be adjusted +3 and +10 degrees between.
- With one hand, the developed system makes it easier to tap beverage intake.
- With magnetic mixing system eliminates the risk of water leakage into the water leakage and engine.
- The low noise level of the class.
- Possibility to use the cup holder thanks to the flat form of the hopper cover.
- All parts in contact with the beverage removable and can be cleaned with ease.

Köpüklü Ayran Makinesi
Sparkling Ayran Maker

Kod Code	Ürün Adı Description	Ebatlar Dimension mm			Ağırlık Weight kg	Net Net m ³	Kapasite Capacity lt	Fiyatı Price Euro
		a	b	c				
EMP.AYR.40	Köpüklü Ayran Makinesi (Ahşap Kaplamalı) Sparkling Ayran Maker (Wooden Decorated)	600	600	1350	78	0.5	40	1.680

Türkçe

KÖPÜKLÜ AYRAN MAKİNESİ

- 220 V / 50 Hz
- 200 Watt.
- 40 litre kapasiteli.
- Kazan temizlik ve tahliye vanası.
- Bardak doldurma musluğu ve alt süzgeci.
- Köpüklü veya köpüksüz ayran doldurma seçeneği.
- İç aydınlatmalı.
- Gövde renk seçenekleri veya reklam & marka kaplama opsiyonu.

English

SPARKLING AYRAN MAKER

- 220 V/ 50 Hz
- 200 Watt.
- 40 lt.capacities.
- Tank cleaning and discharge valve.
- Glass filling sink and sub filter.
- Foomly or foomless yogurt drink options.
- Interior lighting.
- Body colour or brand & advertisement options.



Kod Code	Ürün Adı Description	Ebatlar Dimension mm			Ağırlık Weight kg	Net Net m ³	Kapasite Capacity lt	Fiyatı Price Euro
		a	b	c				
EMP.AYR.40-P	Köpüklü Ayran Makinesi (Paslanmaz Çelik) Sparkling Ayran Maker (Stainless Steel)	600	600	1350	70	0.5	40	1.650

Türkçe

KÖPÜKLÜ AYRAN MAKİNESİ

- 220 V / 50 Hz
- 200 Watt.
- 40 litre kapasiteli.
- Kazan temizlik ve tahliye vanası.
- Bardak doldurma musluğu ve alt süzgeci.
- Köpüklü veya köpüksüz ayran doldurma seçeneği.
- İç aydınlatmalı.

English

SPARKLING AYRAN MAKER

- 220 V/ 50 Hz
- 200 Watt.
- 40 lt.capacities.
- Tank cleaning and discharge valve.
- Glass filling sink and sub filter.
- Foomly or foomless yogurt drink options.
- Interior lighting.



Capuccino Espresso Makineleri
Cappucino Espresso Machines

Kod Code	Ürün Adı Description	Ebatlar Dimension mm			Ağırlık Weight kg	Net Net m³	Kapasite Capacity (lt)	Fiyatı Price Euro
		a	b	c				
EMP.CPC.2GR	Capuccino ve Espresso Makinesi 2 Gruplu Capuccino Espresso Machines 2 Groups	710	545	528	72.5	0.20	10.5	3.250
EMP.CPC.3GR	Capuccino ve Espresso Makinesi 3 Gruplu Capuccino Espresso Machines 3 Groups	1000	565	560	110	0.20	17	4.000



Kod Code	Ürün Adı Description	Ebatlar Dimension mm			Ağırlık Weight kg	Net Net m³	Kapasite Capacity (lt)	Fiyatı Price Euro
		a	b	c				
EMP.CPC.2GB	Capuccino ve Espresso Makinesi 2 Gruplu Capuccino Espresso Machines 2 Groups	710	545	528	72.5	0.20	10.5	3.250
EMP.CPC.3GB	Capuccino ve Espresso Makinesi 3 Gruplu Capuccino Espresso Machines 3 Groups	1000	565	560	110	0.20	17	4.000



Kod Code	Ürün Adı Description	Ebatlar Dimension mm			Ağırlık Weight kg	Net Net m³	Kapasite Capacity (lt)	Fiyatı Price Euro
		a	b	c				
EMP.CCG.01	Kahve Değirmeni Coffee Grinder	210	380	600	9	0.04	2	475

Türkçe

CAPUCCINO ESPRESSO MAKİNELERİ

EMP.CPC.2G

- 230 V. çalışma gücü
- Çift buhar kolu.
- Dozaj ayar ünitesi.
- 2 adet çiftli filtre.
- 10,5 lt kazan kapasitesi.
- Ekstra sıcak su kolu.
- Yarı otomatik.

EMP.CPC.3G

- 230 V. çalışma gücü.
- Çift buhar kolu.
- Dozaj ayar ünitesi.
- 3 adet filtre.
- 17 lt kazan kapasitesi.
- Ekstra sıcak su kolu.
- Yarı otomatik.

EMP.CCG.01

- 230 V - 356 W- 1.75 A.
- Termal koruyuculu motor ekipmanı.
- Maksimum çalışma süresi 30 dk.
- Değirmen çapı 60 mm.
- Hazne kapasitesi 2 kg.
- Dispenser kapasitesi ortalama 2 kg.

English

CAPPUCINO ESPRESSO MACHINES

EMP.CPC.2G

- 230 V operating voltage.
- Double steam arm.
- Dosage adjustment unit.
- 2 double filter handles.
- 10.5 liter boiler capacity.
- Extra-warm water arm.
- Semi automatic.

EMP.CPC.3G

- 230 V operating voltage.
- Double steam arm.
- Dosage adjustment unit.
- 3 double filter handles.
- 17 liter boiler capacity.
- Extra-warm water arm.
- Semi automatic.

EMP.CCG.01

- 230 V - 356 W-1.75 A
- Thermal motor protection equipment.
- Maximum operating time 30 minutes.
- Mill diameter of 60 mm
- Bin capacity 2 kg
- Dispenser average of 2 kg capacity.

Otomatik Capuccino Espresso Makineleri
Automatic Cappucino Espresso Machines

Kod Code	Ürün Adı Description	Ebatlar Dimension mm			Ağırlık Weight kg	Net Net m³	Kapasite Capacity (lt)	Fiyatı Price Euro
		a	b	c				
EMP.CPC.2GR-D	Otomatik Capuccino Espresso Makineleri Automatic Cappucino Espresso Machines	680	590	530	72.5	0.21	11.5	3.950
EMP.CPC.3GR-D	Otomatik Capuccino Espresso Makineleri Automatic Cappucino Espresso Machines	980	590	530	120	0.31	17.5	5.000



Kod Code	Ürün Adı Description	Ebatlar Dimension mm			Ağırlık Weight kg	Net Net m³	Kapasite Capacity (lt)	Fiyatı Price Euro
		a	b	c				
EMP.CPC.2GB-D	Otomatik Capuccino Espresso Makineleri Automatic Cappucino Espresso Machines	680	590	530	72.5	0.21	11.5	3.950
EMP.CPC.3GB-D	Otomatik Capuccino Espresso Makineleri Automatic Cappucino Espresso Machines	980	590	530	120	0.31	17.5	5.000



Kod Code	Ürün Adı Description	Ebatlar Dimension mm		Fiyatı Price Euro
		a	b	
EMP.KC.01	Kahve Çekmecesi Coffee Drawer	410	490	160



Türkçe

OTOMATİK CAPUCCINO ESPRESSO
MAKİNELERİ

EMP.CPC.2G-D

- 230 V. çalışma gücü
- Çift buhar kolu.
- Dozaj ayar ünitesi.
- 2 adet çiftli filtre.
- 11,5 lt kazan kapasitesi.
- Ekstra sıcak su kolu.
- Tam otomatik.

EMP.CPC.3G-D

- 230 V. çalışma gücü.
- Çift buhar kolu.
- Dozaj ayar ünitesi.
- 3 adet filtre.
- 17,5 lt kazan kapasitesi.
- Ekstra sıcak su kolu.
- Tam otomatik.

English

AUTOMATIC CAPPUCINO ESPRESSO
MACHINES

EMP.CPC.2G-D

- 230 V operating voltage.
- Double steam arm.
- Dosage adjustment unit.
- 2 double filter handles.
- 11.5 liter boiler capacity.
- Extra-warm water arm.
- Full automatic.

EMP.CPC.3G-D

- 230 V operating voltage.
- Double steam arm.
- Dosage adjustment unit.
- 3 double filter handles.
- 17,5 liter boiler capacity.
- Extra-warm water arm.
- Full automatic.

Otomatik Dijital Kontrollü

Automatic Digital Board

Demlikli Çay Otomatı
Tea Maker With Pot

EMP.DCY.120



EMP.DCY.250



Kod Code	Ürün Adı Description	Ebatlar Dimension mm			Ağırlık Weight kg	Net Net m³	Güç Power kw	Kapasite Capacity adet/dk-pcs/min	Fiyatı Price Euro
		a	b	c					
EMP.DCY.120	Demlikli Çay Otomatı 120 Bardak Tea Maker With Pot 120 Cups	294	367	400	15	0.04	2	13	305
EMP.DCY.250	Demlikli Çay Otomatı 250 Bardak Tea Maker With Pot 250 Cups	352	425	440	20	0.06	2.5	23	345
EMP.DCY.350	Demlikli Çay Otomatı 350 Bardak Tea Maker With Pot 350 Cups	415	487	455	27	0.09	3.5	37	400

Türkçe

DEMLİKLİ ÇAY OTOMATI

- Termostat kontrol ünitesi.
- Isı yalıtımlı.
- İkaz lambası.
- Paslanmaz çelik iç hazne.

English

TEA MAKER WITH POT

- Thermostat control unit.
- Heating isolation.
- Warning lamp.
- Stainless steel interior reservoir.



EMP.DCY.350

Çay ve Su Otomatları
Tea Maker & Hot Water Dispenser



EMP.SU.80
Su Otomatı
Hot Water Dispenser

EMP.CY.80
Çay Otomatı
Tea Maker

Kod Code	Ürün Adı Description	Ebatlar Dimension mm	Ağırlık Weight kg	Net Net m³	Güç Power kw	Kapasite Capacity lt	Fiyat Price Euro
EMP.CY.80	Çay Otomatı 80 Bardak Tea Maker 80 Cups	Q 235x440	4	0.010	1.75	8	170
EMP.CY.120	Çay Otomatı 120 Bardak Tea Maker 120 Cups	Q 255x485	5	0.012	1.75	13	180
EMP.CY.250	Çay Otomatı 250 Bardak Tea Maker 250 Cups	Q 320x510	7	0.017	2.5	23	215
EMP.CY.400	Çay Otomatı 400 Bardak Tea Maker 400 Cups	Q 390x540	10	0.021	5	40	430
EMP.SU.80	Su Otomatı 80 Bardak Hot Water Dispenser 80 Cups	Q 235x440	3.5	0.010	1.75	8	155
EMP.SU.120	Su Otomatı 120 Bardak Hot Water Dispenser 120 Cups	Q 255x485	3.7	0.012	1.75	13	165
EMP.SU.250	Su Otomatı 250 Bardak Hot Water Dispenser 250 Cups	Q 320x510	5.5	0.017	2.5	23	200
EMP.SU.400	Su Otomatı 400 Bardak Hot Water Dispenser 400 Cups	Q 390x540	8	0.021	5	40	375

Türkçe

ÇAY VE SU OTOMATLARI

- Termostat kontrol ünitesi.
- Paslanmaz çelik gövde.

English

TEA MAKER & HOT
WATER DISPENSER

- Thermostat control unit.
- Stainless steel body.



Çikolata Şelalesi
Chocolate Fountain

Kod Code	Ürün Adı Description	Ebatlar Dimension mm			Ağırlık Weight kg	Net Net m³	Fiyatı Price Euro
		a	b				
EMP.CF.01	Çikolata Şelalesi Chocolate Fountain	350x880			30	0.2	785

Türkçe

ÇİKOLATA ŞELELESİ

- 0.37 kw 1400 d/dk Kw 220 V motor gücü.
- Limit termostat kontrol.
- Ortalama 45°C çalışma ısısı.
- 54 cm çikolata akma mesafesi.
- Kolay temizlik imkanı.
- Paslanmaz çelik gövde.

English

CHOCOLATE FOUNTAIN

- 0.37 Kw 1400 rpm 220 V motor power.
- Safety thermostat.
- 45°C Operation degree.
- 54 cm chocolate flow distance.
- Easy cleaning.
- Stainless steel body.

Sıcak Teşhir Ünitesi (Halojen Istıcılı)
Hot Display Unit (Halogen Lamp)

Kod Code	Ürün Adı Description	Ebatlar Dimension mm			Ağırlık Weight kg	Net Net m³	Güç Power kw	Kapasite Capacity GN	Fiyatı Price Euro
		a	b	c					
EMP.STU.01	Sıcak Teşhir Ünitesi Hot Display Unit	725x570x562			15	0.23	1.3	2x1/1	575



Kod Code	Ürün Adı Description	Ebatlar Dimension mm			Ağırlık Weight kg	Net Net m³	Güç Power kw	Kapasite Capacity GN	Fiyatı Price Euro
		a	b	c					
EMP.STU.02	Sıcak Teşhir Ünitesi Hot Display Unit	1040x570x562			22	0.33	1.9	3x1/1	735

Türkçe

SICAK TEŞHİR ÜNİTESİ

- 220 V çalışma voltajı.
- Termostat kontrollü.
- Pleksiglas üst raf.

English

HOT DISPLAY UNIT

- 220 V operating voltage.
- Safety thermostat.
- Plexiglass top shelf.

Sıcak Teşhir Ünitesi (Halojen Isıtıcı)
Hot Display Unit (Halogen Lamp)

Kod Code	Ürün Adı Description	Ebatlar Dimension mm			Ağırlık Weight kg	Net Net m³	Güç Power kw	Kapasite Capacity GN	Fiyatı Price Euro
		a	b	c					
EMP.AD.8060	Sıcak Teşhir Ünitesi - Ahşap Gövdeli Hot Display Unit - Wooden Body	800x600x120/750			30	0.36	1.3	2x1/1	950
EMP.AD.11060	Sıcak Teşhir Ünitesi - Ahşap Gövdeli Hot Display Unit - Wooden Body	1115x600x120/750			45	0.50	1.8	3x1/1	1.080



Kod Code	Ürün Adı Description	Ebatlar Dimension mm			Ağırlık Weight kg	Net Net m³	Güç Power kw	Kapasite Capacity GN	Fiyatı Price Euro
		a	b	c					
EMP.PD.8060	Sıcak Teşhir Ünitesi - Paslanmaz Gövdeli Hot Display Unit - Stainless Steel Body	800x600x120/750			30	0.36	1.3	2x1/1	790
EMP.PD.11060	Sıcak Teşhir Ünitesi - Paslanmaz Gövdeli Hot Display Unit - Stainless Steel Body	1115x600x120/750			45	0.50	1.8	3x1/1	950



Kod Code	Ürün Adı Description	Ebatlar Dimension mm	Ağırlık Weight kg	Güç Power kw	Fiyatı Price Euro
		Ø			
EMP.GP.40	Güveç & Pizza Isıtma Ünitesi Casserole & Pizza Heater	400	15	0.65	450



Türkçe

SICAK TEŞHİR ÜNİTELERİ

- EMP.AD.8060 - EMP.PD.8060**
- 220 V çalışma voltajı.
 - 1.5 mm Üst tabla kalınlığı.
 - Demonte cam raf.
 - Ayarlanabilir ayak.
 - 30-90 °C arası çalışma ısısı.
 - Dijital kontrol.

- EMP.GP.40**
- 220 V çalışma voltajı.
 - 3 mm Üst tabla kalınlığı.
 - Ayarlanabilir ayak.
 - 30-90 °C arası çalışma ısısı.
 - Dijital kontrol.

English

HOT DISPLAY UNITS

- EMP.AD.8060 - EMP.PD.8060**
- 220 V operating voltage.
 - 1.5 mm Top thickness.
 - Disassembled sneezeguard.
 - Adjustable feet.
 - 30-90 °C worktop temperature.
 - Digital control.

- EMP.GP.40**
- 220 V operating voltage.
 - 3 mm Top thickness.
 - Adjustable feet.
 - 30-90 °C worktop temperature.
 - Digital control.

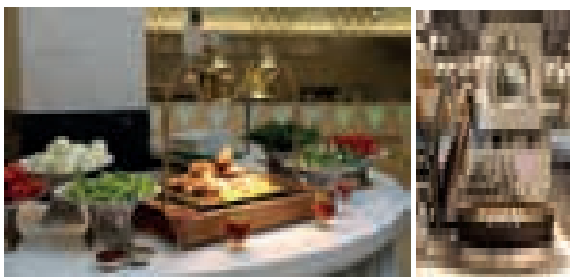

Döner Ocakları (Gazlı)
Shawarma Machines, Gas

Üstten motorlu Döner Ocakları - Gazlı / Gas- Shawarma Machines (Motor on Top)

Kod Code	Ürün Adı Description	Ebatlar Dimension mm			Ağırlık Weight kg	Net Net m ³	Güç Power kw	Isıtıcı Burner	Fiyatı Price Euro
		a	b	c					
EMP.DN.220	Döner Ocağı - Gazlı Shawarma Machine - Gas	752	546	785	25	0.33	10.5	3	670
EMP.DN.221	Döner Ocağı - Gazlı Shawarma Machine - Gas	752	546	1152	31	0.39	14	4	770
EMP.DN.222	Döner Ocağı - Gazlı Shawarma Machine - Gas	760	546	1320	35	0.46	17.5	5	900

Türkçe

ÜSTTEN MOTORLU DÖNER OCAKLARI (GAZLI)

- Lpg veya doğalgazla çalışabilme imkanı.
- 220V-50Hz enerji.
- Magnet emniyet ventilli musluklar.
- Ayarlanabilir döner şişi.
- Çift yöne dönebilme özelliği.
- Hijyenik ve emniyetli.
- Paslanmaz çelik gövde.

English

SHAWARMA MACHINES, GAS (MOTOR ON TOP)

- Lpg or naturel gas.
- 220V-50Hz
- Magnet safety valve.
- Adjustable spear.
- Dual direction option.
- Hygienic and safe.
- Stainless steel body.



Altan motorlu Döner Ocakları Gazlı / Gas- Shawarma Machines (Motor at Bottom)

Kod Code	Ürün Adı Description	Ebatlar Dimension mm			Ağırlık Weight kg	Net Net m ³	Güç Power kw	Isıtıcı Burner	Fiyatı Price Euro
		a	b	c					
EMP.DN.150	Döner Ocağı - Gazlı Shawarma Machine - Gas	737	619	978	30	10.5	10.5	3	860
EMP.DN.151	Döner Ocağı - Gazlı Shawarma Machine - Gas	748	619	1047	38	14	14	4	945
EMP.DN.152	Döner Ocağı - Gazlı Shawarma Machine - Gas	726	621	1217	40	17.5	17.5	5	1.050

Türkçe

ALTAN MOTORLU DÖNER OCAKLARI (GAZLI)

- Lpg veya doğalgazla çalışabilme imkanı.
- 220V-50Hz enerji.
- Magnet emniyet ventilli musluklar.
- Altan hareketli kızaklar döner etinin ısıtıcıya yaklaşmasını sağlar.
- Ayarlanabilir döner şişi.
- Çift yöne dönebilme özelliği.
- Hijyenik ve emniyetli.
- Paslanmaz çelik gövde.

English

SHAWARMA MACHINES, GAS (MOTOR AT BOTTOM)

- Lpg or naturel gas.
- 220V-50Hz
- Magnet safety valve.
- Sliding bottom housing of the spear provides shawarma meat to get closer to burner.
- Adjustable spear.
- Dual direction option.
- Hygienic and safe.
- Stainless steel body.

Paslanmaz Çelik Kanat ve Tepsi Fiyat Farkı / Stainless Steel Side Wings and Buttom Tray



Kod Code	Ürün Adı Description	Fiyatı Price Euro
EMP.KT.01	Kanat Wing	300



Kod Code	Ürün Adı Description	Fiyatı Price Euro
EMP.PT.01	Tepsi Buttom Tray	150
EMP.PT.02	Tepsi Buttom Tray	175
EMP.PT.03	Tepsi Buttom Tray	200

Altan Motorlu Camlı Döner Ocakları (Elektrikli - Gazlı)

Robax Glass Electrical - Gas Shawarma Machines (Motor at bottom)



Altan motorlu Camlı Döner Ocakları - Elektrikli / Electric - Robox Shawarma Machines (Motor at Bottom)

Kod Code	Ürün Adı Description	Ebatlar Dimension mm			Ağırlık Weight kg	Net Net m³	Güç Power kw	Isıtıcı Burner	Fiyatı Price Euro
		a	b	c					
EMP.DN.170	Döner Ocağı - Elektrikli Shawarma Machine - Electrical	710	667	978	30	0.40	4.2	3	1.100
EMP.DN.171	Döner Ocağı - Elektrikli Shawarma Machine - Electrical	741	632	1143	40	0.46	5.6	4	1.245
EMP.DN.172	Döner Ocağı - Elektrikli Shawarma Machine - Electrical	738	667	1305	42.5	0.53	7	5	1.380

Türkçe

ALTTAN MOTORLU CAMLI DÖNER OCAKLARI (ELEKTRİKLİ)

- Düşük ve yüksek 2 kademeli pişirme sıcaklığı.
- 380V-50Hz enerji.
- ROBAX Color S termal cam.
- Altan hareketli kızaklar döner etinin ısıtıcıya yaklaşmasını sağlar.
- Ayarlanabilir döner şişi.
- Çift yöne dönebilme özelliği.
- Hijyenik ve emniyetli.
- Paslanmaz çelik gövde.

English

ROBAX GLASS ELECTRICAL SHAWARMA MACHINES (MOTOR AT BOTTOM)

- Low and high two stage cooking temperature.
- 380V-50 Hz
- ROBAX Color S thermal glass.
- Sliding bottom housing of the spear provides shawarma meat to get closer to burner
- Adjustable spear
- Dual direction option.
- Hygienic and safe.
- Stainless steel body.



Altan motorlu Camlı Döner Ocakları - Gazlı / Gas - Robox Shawarma Machines (Motor at Bottom)

Kod Code	Ürün Adı Description	Ebatlar Dimension mm			Ağırlık Weight kg	Net Net m³	Güç Power kw	Isıtıcı Burner	Fiyatı Price Euro
		a	b	c					
EMP.DN.210	Döner Ocağı - Gazlı Shawarma Machine - Gas	737	667	978	31.5	0.40	10.5	3	1.100
EMP.DN.211	Döner Ocağı - Gazlı Shawarma Machine - Gas	737	667	1137	40	0.46	14	4	1.245
EMP.DN.212	Döner Ocağı - Gazlı Shawarma Machine - Gas	737	667	1305	42.5	0.53	17.5	5	1.380

Türkçe

ALTTAN MOTORLU CAMLI DÖNER OCAKLARI (GAZLI)

- Lpg veya doğalgazla çalışabilme imkanı.
- 220V-50Hz enerji.
- ROBAX Color S termal cam.
- Magnet emniyet ventilli musluklar.
- Altan hareketli kızaklar döner etinin ısıtıcıya yaklaşmasını sağlar.
- Ayarlanabilir döner şişi.
- Çift yöne dönebilme özelliği.
- Hijyenik ve emniyetli.
- Paslanmaz çelik gövde.

English

ROBAX GLASS GAS SHAWARMA MACHINES (MOTOR AT BOTTOM)

- Lpg or naturel gas.
- 220V-50 Hz
- ROBAX Color S thermal glass.
- Magnet safety valves.
- Sliding bottom housing of the spear provides shawarma meat to get closer to burner
- Adjustable spear
- Dual direction option.
- Hygienic and safe.
- Stainless steel body.



Paslanmaz Çelik Kanat ve Tepsi Fiyat Farkı / Stainless Steel Side Wings and Buttom Tray



Kod Code	Ürün Adı Description	Fiyatı Price Euro
EMP.KT.01	Kanat Wing	300



Kod Code	Ürün Adı Description	Fiyatı Price Euro
EMP.PT.01	Tepsi Buttom Tray	150
EMP.PT.02	Tepsi Buttom Tray	175
EMP.PT.03	Tepsi Buttom Tray	200

- 3 Radyanlı/3 Burner : EMP.KT.01 ve EMP.PT.01
- 4 Radyanlı/4 Burner : EMP.KT.01 ve EMP.PT.02
- 5 Radyanlı/5 Burner : EMP.KT.01 ve EMP.PT.03

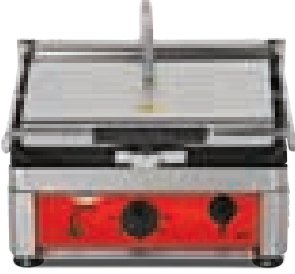
Tost Makineleri (Elektrikli)
Toaster (Electrical)

Kod Code	Ürün Adı Description	Ebatlar Dimension mm			Ağırlık Weight kg	Net Net m ³	Güç Power kw	Fiyatı Price Euro
		a	b	c				
EMP.101	Tost Makineleri (Tekli) Toaster (Single)	400	360	210	30	0.03	1.75	345

Türkçe
TOST MAKİNELERİ (ELEKTRİKLİ)

- 220V 50 Hz enerji.
- Izgara olarak kullanabilme özelliği.
- Hijyenik ve emniyetli.
- Paslanmaz çelik gövde.

English
TOASTER (ELECTRICAL)

- 220V 50 Hz energy.
- Capable for operation as a grill.
- Hygienic and safe.
- Stainless steel body.



Kod Code	Ürün Adı Description	Ebatlar Dimension mm			Ağırlık Weight kg	Net Net m ³	Güç Power kw	Fiyatı Price Euro
		a	b	c				
EMP.102	Tost Makineleri (Blok) Toaster (Block)	540	300	210	33	0.04	1.95	410

Türkçe
TOST MAKİNELERİ (ELEKTRİKLİ)

- 220V 50 Hz enerji.
- Izgara olarak kullanabilme özelliği.
- Hijyenik ve emniyetli.
- Paslanmaz çelik gövde.

English
TOASTER (ELECTRICAL)

- 220V 50 Hz energy.
- Capable for operation as a grill.
- Hygienic and safe.
- Stainless steel body.



Kod Code	Ürün Adı Description	Ebatlar Dimension mm			Ağırlık Weight kg	Net Net m ³	Güç Power kw	Fiyatı Price Euro
		a	b	c				
EMP.103	Tost Makineleri (Çiftli) Toaster (Double)	540	300	210	35	0.04	2.95	485

Türkçe
TOST MAKİNELERİ (ELEKTRİKLİ)

- 220V 50 Hz enerji.
- Izgara olarak kullanabilme özelliği.
- Hijyenik ve emniyetli.
- Paslanmaz çelik gövde.

English
TOASTER (ELECTRICAL)

- 220V 50 Hz energy.
- Capable for operation as a grill.
- Hygienic and safe.
- Stainless steel body.

Konveyörlü Ekmek Kızartma Makinesi
Conveyor Toaster

Kod Code	Ürün Adı Description	Ebatlar Dimension mm			Ağırlık Weight kg	Net Net m ³	Güç Power kw	Fiyatı Price Euro
		a	b	c				
EMP.MEK010	Konveyörlü Ekmek Kızartma Makinesi Conveyor Toaster	478	600	420	35	0.12	3.5	915

Türkçe
**KONVEYÖRLÜ EKMEK KIZARTMA
MAKİNESİ**

- 600 dilim / saat kapasitesi.
- Termostatik kontrol.
- Paslanmaz çelik taşıyıcı tel.
- Kolay temizlenebilen ve hijyeniktir.
- Paslanmaz çelik gövde.

English
CONVEYOR TOASTER

- Capacity: 600 bread slice / hour.
- Thermostatic controller.
- Stainless steel conveyor wire.
- Easy to clean and hygienic.
- Stainless steel body.

Kod Code	Elektrik Girişi Electric Input	Kablo Kesiti Cable Cross Section
EMP.MEK010	230 V.AC N PE	3 x 2.5

Krep ve Waffle Makinesi
Crepe & Waffel Maker

Kod Code	Ürün Adı Description	Ebatlar Dimension mm	Ağırlık Weight kg	Net Net m³	Güç Power kw	Kapasite Capacity cm	Fiyatı Price Euro
EMP.KR.010	Krep Makinesi - Classico Crep Maker - Classico	450x520x240	19	0.06	2,2	40 Ø	395



Türkçe

KREP MAKİNESİ

- 220 V 50 Hz. enerji.
- Estetik ve fonksiyonel tasarım.
- Paslanmaz çelik gövde.

English

CREPE MAKER

- 220 V 50 Hz. energy.
- Functional design.
- Stainless steel body.

Kod Code	Ürün Adı Description	Ebatlar Dimension mm	Ağırlık Weight kg	Net Net m³	Güç Power kw	Kapasite Capacity cm	Fiyatı Price Euro
EMP.KR.020	Krep Makinesi - Classico Crep Maker - Classico	900x520x240	37	0.12	2x2,2	2x(40 Ø)	750



Türkçe

KREP MAKİNESİ

- 220 V 50 Hz. enerji.
- Estetik ve fonksiyonel tasarım.
- Paslanmaz çelik gövde.

English

CREPE MAKER

- 220 V 50 Hz. energy.
- Functional design.
- Stainless steel body.

Kod Code	Ürün Adı Description	Ebatlar Dimension mm	Ağırlık Weight kg	Net Net m³	Güç Power kw	Kapasite Capacity cm	Fiyatı Price Euro
EMP.WF.010	Waffle Makinesi - Waffelino Waffel Maker - Waffelino	300x320x300	31	0.03	2,2	2x(10x17)	345



Türkçe

WAFFLE MAKİNESİ

- 220 V 50 Hz. enerji.
- Estetik ve fonksiyonel tasarım.
- Paslanmaz çelik gövde.

English

WAFFEL MAKER

- 220 V 50 Hz. energy.
- Functional design.
- Stainless steel.

Kod Code	Ürün Adı Description	Ebatlar Dimension mm	Ağırlık Weight kg	Net Net m³	Güç Power kw	Kapasite Capacity cm	Fiyatı Price Euro
EMP.WF.020	Waffle Makinesi - Waffelino Waffel Maker - Waffelino	600x320x300	63	0.06	2x2,2	4x(10x17)	575



Türkçe

WAFFLE MAKİNESİ

- 220 V 50 Hz. enerji.
- Estetik ve fonksiyonel tasarım.
- Paslanmaz çelik gövde.

English

WAFFEL MAKER

- 220 V 50 Hz. energy.
- Functional design.
- Stainless steel.

Elektrikli ve Gazlı Salamander Izgara
Electric & Gas Salamander Grill

Kod Code	Ürün Adı Description	Ebatlar Dimension mm			Ağırlık Weight kg	Net Net m³	Güç Power kw	Fiyatı Price Euro
		a	b	c				
EMP.PSE020	Elektrikli Salamander Izgara Electric Salamander Grill	660	530	470	62	0.16	3.4	915

Kod Code	Elektrik Girişi Electric Input	Kablo Kesiti Cable Cross Section
EMP.PSE020	230 V.AC 1N PE	3 x 2.5

Türkçe

ELEKTRİKLİ SALAMANDER IZGARA

- Termostatik kumanda.
- Isıtma sistemi yukarı ve aşağıya yakınlaştırılabilir.
- Kolay temizlenebilir ve hijyeniktir.
- Paslanmaz çelik gövde.

English

ELECTRIC SALAMANDER GRILL

- Thermostatic controller.
- Slides can be adjusted on a different height.
- Easy to clean and hygienic.
- Stainless steel body.



Kod Code	Ürün Adı Description	Ebatlar Dimension mm			Ağırlık Weight kg	Net Net m³	Güç Power kw	Fiyatı Price Euro
		a	b	c				
EMP.PSG.3	3 Brülörlü Gazlı Salamander Izgara 3 Burners Gas Salamander Grill	835	440	600	42	0.22	10.5	840
EMP.PSG.4	4 Brülörlü Gazlı Salamander Izgara 4 Burners Gas Salamander Grill	970	440	600	50	0.26	14	1.000
EMP.PSG.5	5 Brülörlü Gazlı Salamander Izgara 5 Burners Gas Salamander Grill	1105	440	600	59	0.30	17.5	1.155
EMP.PSG.6	6 Brülörlü Gazlı Salamander Izgara 6 Burners Gas Salamander Grill	1240	440	600	67	0.33	21	1.365

Kod Code	Gaz Tüketim Değeri Gas Consumption Ng	Gaz Tüketim Değeri Gas Consumption Lpg
EMP.PSG.3	1,10 m³/h	0,58 kg/h
EMP.PSG.4	1,48 m³/h	0,77 kg/h
EMP.PSG.5	1,85 m³/h	0,97 kg/h
EMP.PSG.6	2,20 m³/h	1,16 kg/h

Türkçe

GAZLI SALAMANDER IZGARA

- Isıtma sistemi yukarı ve aşağı yakınlaştırılabilir.
- Ventilli gaz musluğu aracılığıyla ısı derecesi ayarı.
- Cihaza nemlendirme özelliği katan hareketli alt tepsi.
- Paslanmaz çelik gövde.

English

GAS SALAMANDER GRILL

- Slides can be adjusted on a different height.
- Gas valve provides temperature control.
- Moisturizing option by the removable tray.
- Stainless steel body.



Bulařikhane

Dishwasher



Life's Magic | Kitchen of Business

empero@empero.com.tr



- * Bardak Yıkama Makinesi / Glasswasher
- * Set Altı Bulařık Makinesi / Undercounter Type Dishwasher
- * Giyotin Tipi Bulařık Makinesi / Hood Type Dishwasher
- * Set Altı Bulařık Makinesi - Çift Cidarlı / Undercounter Type Dishwasher - Double Skin
- * Giyotin Tipi Bulařık Makinesi- Çift Cidarlı / Hood Type Dishwasher - Double Skin
- * Konveyörlü Bulařık Makineleri (Kurutma Ünitesi) / Conveyor Type Dishwasher (Drying Unit)

Bardak Yıkama Makinesi Glasswasher



Kod Code	Ürün Adı Description	Ebatlar Dimension mm			Ağırlık Weight kg	Net Net m³	Kapasite Capacity bardak/saat-glass/Hour	Fiyatı Price Euro
		a	b	c				
EMP.1100	Bardak Yıkama Makinesi Glasswasher	480	580	720	41	0.02	1000	1.450

Türkçe

BARDAK YIKAMA MAKİNESİ

- Parlatıcı pompası : Standart.
- Drenaj pompası : Standart.
- 3,2 kw makine gücü.
- 90°-120°,-180° C saniye olmak üzere 3 farklı program özelliği.
- 220 v işletim sistemi.
- 400x400 mm basket.

English

GLASSWASHER

- Built in rinse aid dispenser.
- Drain pump.
- Total Power:3,2 kw.
- Programme options: 90°,-120°,-180° C seconds.
- 220 v operating system.
- 400x400 mm basket dimension.



Set Altı Bulaşık Makinesi Undercounter Type Dishwasher

Kod Code	Ürün Adı Description	Ebatlar Dimension mm			Ağırlık Weight kg	Net Net m³	Kapasite Capacity tabak/saat-plate/hour	Fiyatı Price Euro
		a	b	c				
EMP.500	Set Altı Bulaşık Makinesi Undercounter Type Dishwasher	590	700	820	67	0.33	500	1.500
EMP.500-380	Set Altı Bulaşık Makinesi-380 Volt Undercounter Type Dishwasher-380 Volt	590	700	820	67	0.33	500	1.500
	Su Basınç Pompası Fiyat Farkı Price Difference for Water Pressure Pump							350

Türkçe

SET ALTI BULAŞIK MAKİNESİ

- Drenaj pompası : Standart.
- 90°-120°,-180° C saniye olmak üzere 3 farklı program özelliği.
- 0.55 kw 2800 D/Dk motor gücü.
- EMP.500 için; 6 kw 220 V makine toplam gücü.
- EMP.500-380 için; 8 kw 380 V makine toplam gücü.
- 2.5 kw yıkama tankı gücü.
- EMP.500 için; 3 kw durulama tankı gücü.
- EMP.500-380 için; 5 kw durulama tankı gücü
- Paslanmaz çelik rezistans.
- 320 mm maksimum tabak çapı.
- 2.5 lt/sefer su sarfiyatı.
- Manyetik kapı güvenlik sensörü.
- Kapak kapandığında programın durduğu yerden başlatma özelliği.
- Tam ve otomatik yıkama 55° C gerçekleşirken sıcak su ile durulama işlemi 80°-85° C de gerçekleşir.
- Paslanmaz çelik gövde.

English

UNDERCOUNTER TYPE DISHWASHER

- Drainage pump : Standart.
- Programme options: 90°,-120°,-180° C seconds.
- Motor Power:0.55 kw 2800 rpm.
- EMP.500 total power; 6 kw 220 V
- EMP.500-380 total power; 8 kw 380 V
- Tank heating power:2.5 kw
- EMP.500 rinse boiler power; 3 kw
- EMP.500-380: rinse boiler power; 5 kw
- Stainless steel resistance.
- Maximum plate diameter:320 mm
- Water consumption: 2.5 lt/time.
- Magnetic security switch.
- Programme continues the process by closing of the door.
- Full automatic washing operation at 55°C, rinsing operation with hot water at 80-85°C.
- Stainless steel body.



Su basınç pompası şebeke basıncının 2.5 bar'ın altında olduğu yerlerde kullanılır.

Water pressure pump is required for below 2.5 bar water connections.

Giyotin Tipi Bulaşık Makinesi
Hood Type Dishwasher

Kod Code	Ürün Adı Description	Ebatlar Dimension mm			Ağırlık Weight kg	Net Net m³	Kapasite Capacity tabak/saat-plate/hour	Fiyatı Price Euro
		a	b	c				
EMP.1000	Giyotin Tipi Bulaşık Makinesi Hood Type Dishwasher	696x765x1485			120	0.79	1000	2.200
	Su Basınç Pompası Fiyat Farkı Price Difference for Water Pressure Pump							350

Kod Code	Ürün Adı Description	Ebatlar Dimension mm			Net Net m³	Fiyatı Price Euro
		a	b	c		
EMP.TB.01	Tabak Basketi Dish Basket	500x500x110			0.02	18
EMP.KC.01	Kaşık Çatal Basketi Cutlery Basket	500x500x110			0.02	18
EMP.BB.01	Bardak Basketi Glass Basket	500x500x110			0.02	20

Su basınç pompası şebeke basıncının 2.5 bar'ın altında olduğu yerlerde kullanılır.

Water pressure pump is required for below 2.5 bar water connections.

Türkçe

GIYOTİN TİPİ BULAŞIK MAKİNESİ

- 60°, -90°, -120°, -180° C saniye program özelliği.
- 0.55 kw 2800 D/Dk motor gücü.
- 9.5 kw 380 V makine toplam gücü.
- 2.8 kw tank ısıtma gücü.
- 6 kw durulama suyu boyler gücü.
- Paslanmaz çelik rezistans.
- Termostat kontrolü. (Yıkama ısısı 60°)
- 2.5 lt/sefer su sarfiyatı.
- Manyetik kapı güvenlik sensörü.
- Kapak kapandığında programın durduğu yerden başlatma özelliği.
- Tam ve otomatik yıkama 55° C gerçekleşirken sıcak su ile durulama işlemi 80°-85° C de gerçekleşir.
- Paslanmaz çelik gövde.

English

HOOD TYPE DISHWASHER

- 60°, 90°, 120°, 180° C seconds programme options.
- Motor Power:0.55 kw 2800 rpm.
- Total Power:9.5 kw 380 V
- Tank heating power:2.8 kw
- Rinse boiler heating:6 kw
- Stainless steel resistance.
- Thermostat control. (washing temperature:60°C)
- Water consumption: 2.5 lt/time.
- Magnetic security switch.
- Programme continues the process by closing of the door.
- Full automatic washing operation at 55° C rinsing operation with hot water at 80°-85° C.
- Stainless steel body.

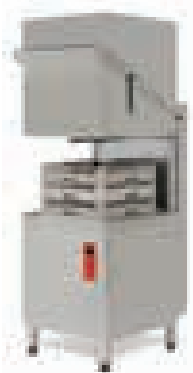
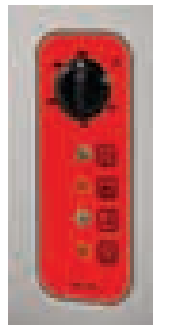

Set Altı Bulaşık Makinesi - Çift Cidarlı
Undercounter Type Dishwasher - Double Skin



Atmosferik boylerli ve çift taşıma pompalı.
Atmospheric boiler and break-tank device.

Kod Code	Ürün Adı Description	Ebatlar Dimension mm			Ağırlık Weight kg	Net Net m³	Kapasite Capacity tabak/saat- plate/hour	Fiyatı Price Euro
		a	b	c				
EMP.500-D	Set Altı Bulaşık Makinesi - Çift Cidarlı Undercounter Type Dishwasher - Double Skin	600	600	820	72	0.33	720	2.550
EMP.500-D-380	Set Altı Bulaşık Makinesi - Çift Cidarlı-380 Volt Undercounter Type Dishwasher - Double Skin-380 Volt	600	600	820	72	0.33	720	2.550

Türkçe

SET ALTI BULAŞIK MAKİNESİ - ÇİFT CİDARLI

- Drenaj Pompası: Standart.
- Deterjan Pompası: Standart.
- Parlatıcı Pompası: Standart.
- Su Basınç Pompası: Standart.
- ÇİFT CİDARLI GÖVDE.
- Dijital Kontrol.
- Atmosferik boylerli ve çift taşıma pompalı.
- Hızlı , normal , yoğun ve kendi kendini temizleme programı.
- Bardaklar , tava ve tepsiler , çatal ve kaşık , sanitizasyon (medikal sektör için) 4 farklı yıkama programı.
- 90,120,180 saniye olmak üzere 3 farklı program özelliği.
- 0.55 kw 2800 D/Dk motor gücü.
- EMP.500-D için; 6 kw 220 V makine toplam gücü.
- EMP.500-D-380 için; 8 kw 380 V makine toplam gücü.
- 2.5 kw yıkama tankı gücü.
- EMP.500-D için; 3 kw durulama tankı gücü.
- EMP.500-D-380 için; 5 kw durulama tankı gücü.
- Paslanmaz çelik rezistans.
- 320 mm maksimum tabak çapı.
- 2 lt / sefer su sarfiyatı.
- Manyetik kapı güvenlik sensörü.
- Kapak kapatıldığında programın durduğu yerden başlatma özelliği.
- Tam ve otomatik yıkama 55 C gerçekleşirken sıcak su ile durulama işlemi 80-85C'de gerçekleşir.
- Paslanmaz çelik gövde.

Dijital Kontrol Panosu

- 2.4 inç renkli ekran.
- Aydınlatmalı dokunmatik kontrol panosu.
- Yıkama motoru kontrolü.
- Durulama motoru kontrolü.
- Tahliye kontrolü.
- Boyler ve tank sıcaklığını ayrı ayrı kontrol etme özelliği.
- Soft-start özelliği.
- Su geçirmez ön panel.

English

UNDERCOUNTER TYPE DISHWASHER - DOUBLE SKIN

- Drainage Pump: Standart.
- Detergent Pump: Standart.
- Polishing Pump: Standart.
- Water Pressure Pump: Standart.
- DOUBLE SKIN BODY.
- Digital control.
- Atmospheric boiler and break-tank device.
- Fast , normal , busy and self cleaning programmes.
- 4 different programme for ; glasses , pans and trays,cutlery , sanitization / Medical.
- Programme options:90,120,180 seconds.
- Motor Power :0.55 kw 2800rpm.
- EMP.500-D total power; 6 kw 220 V
- EMP.500-D-380 total power; 8 kw 380 V
- Tank heating power : 2.5 kw
- EMP.500-D rinse boiler power; 3 kw
- EMP.500-D-380 rinse boiler power; 5 kw
- Stainless steel resistance.
- Maximum plate diameter : 320mm
- Water consumption: 2 lt / time.
- Magnetic door switch.
- Programme continues the process by closing the door.
- Full automatic washing operation at 55 C , rinsing operation with hot water at 80-85 C.
- Stainless steel body.

Digital Control Board

- 2.4 inch colored screen.
- Enlightened touch screen control panel.
- Motor control.
- Washing motor control.
- Drain control.
- Seperate control for boiler and the tank.
- Soft-start option.
- Water proof control panel.

Giyotin Tipi Bulaşık Makinesi- Çift Cidarlı
Hood Type Dishwasher - Double SkinAtmosferik boylerli ve çift taşıma pompalı.
Atmospheric boiler and break-tank device.

Kod Code	Ürün Adı Description	Ebatlar Dimension mm			Ağırlık Weight kg	Net Net m³	Kapasite Capacity tabak/saat-plate/hour	Fiyatı Price Euro
		a	b	c				
EMP.1000-D	Giyotin Tipi Bulaşık Makinesi - Çift Cidarlı Hood Type Dishwasher - Double Skin	720	840	1570	150	0.95	1300	3.300

Kod Code	Ürün Adı Description	Ebatlar Dimension mm			Net Net m³	Fiyatı Price Euro
		a	b	c		
EMP.TB.01	Tabak Basketi Dish Basket	500	500	110	0.02	18
EMP.KC.01	Kaşık Çatal Basketi Cutlery Basket	500	500	110	0.02	18
EMP.BB.01	Bardak Basketi Glass Basket	500	500	110	0.02	20

Türkçe

GIYOTİN TİPİ BULAŞIK MAKİNESİ - ÇİFT CİDARLI

- Drenaj Pompası: Standart.
- Deterjan Pompası: Standart.
- Parlatıcı Pompası: Standart.
- Su Basınç Pompası : Standart.
- ÇİFT CİDARLI GÖVDE.
- Dijital Kontrol.
- Atmosferik boylerli ve çift taşıma pompalı.
- Hızlı , normal , yoğun ve kendi kendini temizleme programı.
- Bardaklar , tava ve tepsiler , çatal ve kaşık , sanitizasyon (medikal sektör için) 4 farklı yıkama programı.
- 60, 90,120,180 saniye olmak üzere 4 farklı program özelliği.
- 0.55 kw 2800 D/Dk motor gücü.
- 9.5 kw 380 volt makine toplam gücü.
- 2.8 kw yıkama tankı gücü.
- 6 kw durulama tankı gücü.
- Paslanmaz çelik rezistans.
- 2 lt / sefer su sarfiyatı.
- Tam ve otomatik yıkama 55 C gerçekleşirken sıcak su ile durulama işlemi 80-85C'de gerçekleşir.
- Paslanmaz çelik gövde.

Dijital Kontrol Panosu

- 2.4 inç renkli ekran.
- Aydınlatmalı dokunmatik kontrol panosu.
- Yıkama motoru kontrolü.
- Durulama motoru kontrolü.
- Tahliye kontrolü.
- Boyler ve tank sıcaklığını ayrı ayrı kontrol etme özelliği.
- Soft-start özelliği.
- Su geçirmez ön panel.

English

HOOD TYPE DISHWASHER - DOUBLE SKIN

- Drainage Pump: Standart.
- Detergent Pump: Standart.
- Polishing Pump: Standart.
- Water Pressure Pump: Standart.
- DOUBLE SKIN BODY.
- Digital control.
- Atmospheric boiler and break-tank device.
- Fast , normal , busy and self cleaning programmes.
- 4 different programme for ; glasses , pans and trays,cutlery , sanitization / Medical.
- Programme options: 60,90,120,180 seconds.
- Motor Power :0.55 kw 2800rpm.
- Total Power : 9.5 kw 380 V.
- Tank heating power : 2.8 kw
- Rinse boiler heating : 6 kw
- Stainless steel resistance.
- Water consumption: 2 lt / time.
- Full automatic washing operation at 55 C , rinsing operation with hot water at 80-85 C.
- Stainless steel body.

Digital Control Board

- 2.4 inch colored screen.
- Enlightened touch screen control panel.
- Motor control.
- Washing motor control.
- Drain control.
- Seperate control for boiler and the tank.
- Soft-start option.
- Water proof control panel.

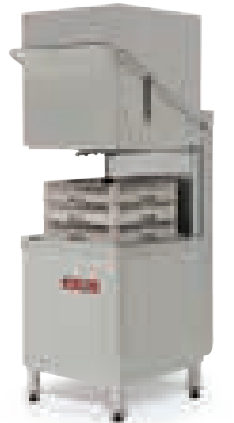

Konveyörlü Bulaşık Makineleri (Kurutma Ünitesi) Conveyor Type Dishwasher (Drying Unit)

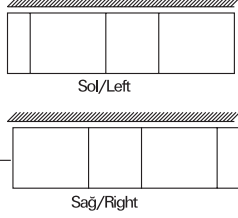

Lütfen Giriş Yönünü Belirtiniz.
Please Point Out the Inlet Direction.



Kod Code	Ürün Adı Description	Ebatlar Dimension mm			Ağırlık Weight kg	Net Net m ³	Kapasite Capacity tabak / saat plate / hour	Fiyatı Price Euro
		a	b	c				
EMP.2000-SAG-R	Konveyörlü Bulaşık Makineleri Conveyor Type Dishwasher with Drying Tunnel	2040	830	1850	303	3.21	2000	7.000
EMP.2000-SOL-L	Konveyörlü Bulaşık Makineleri Conveyor Type Dishwasher with Drying Tunnel	2040	830	1850	303	3.21	2000	7.000
EMP.2000.ÖY-SAG-R	Konveyörlü Bulaşık Makineleri (Ön Yıkamalı) Conveyor Type Dishwasher with Drying Tunnel - (With Prewashing Unit)	2790	830	1850	378	4.6	2000	9.000
EMP.2000.ÖY-SOL-L	Konveyörlü Bulaşık Makineleri (Ön Yıkamalı) Conveyor Type Dishwasher with Drying Tunnel - (With Prewashing Unit)	2790	830	1850	378	4.6	2000	9.000

Türkçe

KONVEYÖRLÜ BULAŞIK MAKİNELERİ

- Kurutma tüneli : Standart.
- İki hızlı konveyör bandı.
- İki adet yıkama motoru.
- 27 KW boiler gücü.
- 9 KW tank gücü.
- 9 KW kurutma ünitesi motor gücü.
- Ön yıkamasız makineler için motor gücü ;
0.35 Kw 2800 D/Dk x 2
- Ön yıkamalı makineler için motor gücü ;
0.35 Kw 2800 D/Dk x 3
- 50 Kw 380 V makine toplam gücü.
- Tam ve otomatik yıkama 55° C gerçekleşirken sıcak su ile durulama işlemi 80°-85° C de gerçekleşir.
- Manyetik kapı güvenlik sensörü.
- Paslanmaz çelik rezistanlar.
- Paslanmaz çelik gövde.

English

CONVEYOR TYPE DISHWASHER DRYING TUNNEL

- Drying Tunnel:Standart.
- Two speed conveyor band.
- Two pieces of washing motors.
- Boiler power: 27 KW
- Tank Power: 9 KW
- Drying unit motor power: 9 KW
- Motor property for conveyor type dishwasher without prewashing unit types
0.35 kw 2800 rpm x 2
- Motor property for pre-washing machines
0.35 kw 2800 rpm x 3
- Total power: 50 kw 380 V
- Full automatic washing operation at 55° C, rinsing operation with hot water at 80-85° C.
- Magnetic security switch.
- Stainless steel resistances.
- Stainless steel body.



İş'in Mutfacı / Kitchen of Business





Piřınme
Snack Serisi
Cooking-Snack Series



It's in Myself / Kitchen of Business

empero@empero.com.tr

Piřırme-Snack Serisi
Cooking-Snack Series



- * **Gazlı Ocaklar / Gas Ranges**
- * **Elektrikli Sulu Izgaralar / Electric Chargrill**
- * **Elektrikli Ocaklar / Electric Ranges**
- * **Gazlı - Elektrikli Fritözler / Gas - Electric Fryers**
- * **Elektrikli Makarna Hařlama-Patates Dinlendirme / Electric Pasta Cooker-Chips Scuttle**
- * **Gazlı Izgaralar / Gas Grills**
- * **Elektrikli Izgaralar / Electric Grills**
- * **Gazlı Lavatařlı Izgaralar / Gas Lavastone Grills**
- * **Gazlı Sulu Izgara / Gas Vapor Grill**
- * **Elektrikli Benmariler / Electric Bain maries**
- * **Set Altı ve Ara Tezgahlar / Worktop and Undercounter Cabinet**
- * **Set Altı ve Ara Tezgahlar / Worktop and Undercounter Cabinet**

Gazlı Ocaklar
Gas Ranges



Yüksek yarışlı piştirme için
High pressure cooking

Kod Code	Ürün Adı Description	Ebatlar Dimension mm			Ağırlık Weight kg	Net Net m ³	Güç Power kw	Fiyatı Price Euro
		a	b	c				
EMP.6KG010-O	1 Brülör'lü Gazlı Ocak-Büyük Brülör 1 Burner Gas Range – Big Burners	400 x 635 x 285			22	0,1	8.65	575



Kod Code	Gaz Tüketim Değeri Gas Consumption Ng	Gaz Tüketim Değeri Gas Consumption Lpg
EMP.6KG010-O	0,83 m ³ /h	0,60 kg/h

Türkçe

GAZLI OCAKLAR

- Lpg ve Ng ile çalışabilme özelliği.
- Magnet emniyet ventilli musluklar.
- Özel emaye kaplı güçlü ızgara.
- Kademeli şalter.
- Çift yarışlı brülör.
- Her brülör için piezzo çakmak ile kontrol.
- Kolay temizlenebilir ve hijyeniktir.
- Paslanmaz çelik gövde.

English

GAS RANGES

- Lpg or Natural Gas.
- Magnet safety valves.
- Solid enamelled cast iron.
- Positioned switch.
- Double ring burner.
- Piezo electric ignition system for each module.
- Easy to clean and hygienic.
- Stainless steel body.

Kod Code	Ürün Adı Description	Ebatlar Dimension mm			Ağırlık Weight kg	Net Net m ³	Güç Power kw	Fiyatı Price Euro
		a	b	c				
EMP.6KG020-O	2 Brülör'lü Gazlı Ocak-Büyük Brülör 2 Burner Gas Range – Big Burners	800 x 635 x 285			45	0,2	17.30	960



Kod Code	Gaz Tüketim Değeri Gas Consumption Ng	Gaz Tüketim Değeri Gas Consumption Lpg
EMP.6KG020-O	1,83 m ³ /h	1,19 kg/h

Türkçe

GAZLI OCAKLAR

- Lpg ve Ng ile çalışabilme özelliği.
- Magnet emniyet ventilli musluklar.
- Özel emaye kaplı güçlü ızgara.
- Kademeli şalter.
- Çift yarışlı brülör.
- Her brülör için piezzo çakmak ile kontrol.
- Kolay temizlenebilir ve hijyeniktir.
- Paslanmaz çelik gövde.

English

GAS RANGES

- Lpg or Natural Gas.
- Magnet safety valves.
- Solid enamelled cast iron.
- Positioned switch.
- Double ring burner.
- Piezo electric ignition system for each module.
- Easy to clean and hygienic.
- Stainless steel body.

NEW**EMPERO****Pişirme-Snack Serisi**
Cooking-Snack Series**Elektrikli Sulu Izgaralar**
Electric Charrill

Kod Code	Ürün Adı Description	Ebatlar Dimension mm			Ağırlık Weight kg	Net Net m³	Güç Power kw	Fiyatı Price Euro
		a	b	c				
EMP.6LE010	Elektrikli Sulu Izgaralar Electric Charrill	400	600	290	45	0.11	3.75	1.600



Kod Code	Ürün Adı Description	Ebatlar Dimension mm			Ağırlık Weight kg	Net Net m³	Güç Power kw	Fiyatı Price Euro
		a	b	c				
EMP.6LE020	Elektrikli Sulu Izgaralar Electric Charrill	600	600	290	60	0.17	6.25	2.100



Kod Code	Ürün Adı Description	Ebatlar Dimension mm			Ağırlık Weight kg	Net Net m³	Güç Power kw	Fiyatı Price Euro
		a	b	c				
EMP.6LE030	Elektrikli Sulu Izgaralar Electric Charrill	800	600	290	85	0.24	8.75	2.250



Kod Code	Ürün Adı Description	Ebatlar Dimension mm			Ağırlık Weight kg	Net Net m³	Güç Power kw	Fiyatı Price Euro
		a	b	c				
EMP.6LE040	Elektrikli Sulu Izgaralar Electric Charrill	1200	600	290	105	0.25	13.75	2.400

Türkçe**ELEKTRİKLİ SULU IZGARALAR**

- Buharlaştırma kabini sayesinde daha verimli pişirme.
- Kolay kaldırılabilir rezistanslar sayesinde kolay temizlik imkanı.
- Daha kısa sürede daha az enerji ile pişirme imkanı.
- Kolay temizlenebilir ve hijyeniktir.
- Paslanmaz çelik gövde.

English**ELECTRIC CHARRILL**

- Steamer cabinet provides fertile cooking.
- Easy tilting heaters provide easy cleaning.
- Faster cooking with low energy.
- Easy to clean and hygienic.
- Stainless steel body.



Elektrikli Ocaklar
Electric Ranges



Kod Code	Ürün Adı Description	Ebatlar Dimension mm			Ağırlık Weight kg	Net Net m³	Güç Power kw	Fiyatı Price Euro
		a	b	c				
EMP.6KG010	2 Brülör'lü Gazlı Ocak 2 Burner Gas Range	400	635	285	24	0.11	7.1	480

Kod Code	Gaz Tüketim Değeri Gas Consumption Ng	Gaz Tüketim Değeri Gas Consumption Lpg
EMP.6KG010	0,75 m³/h	0,55 kg/h

Kod Code	Ürün Adı Description	Ebatlar Dimension mm			Ağırlık Weight kg	Net Net m³	Güç Power kw	Fiyatı Price Euro
		a	b	c				
EMP.6KG020	4 Brülör'lü Gazlı Ocak 4 Burner Gas Range	600	635	285	44	0.17	14.2	800

Kod Code	Gaz Tüketim Değeri Gas Consumption Ng	Gaz Tüketim Değeri Gas Consumption Lpg
EMP.6KG020	1,5 m³/h	1,1 kg/h

Kod Code	Ürün Adı Description	Ebatlar Dimension mm			Ağırlık Weight kg	Net Net m³	Güç Power kw	Fiyatı Price Euro
		a	b	c				
EMP.6KE010	2 Pleyt'li Elektrikli Ocak 2 Hot Plate Electric Range	400	635	285	20	0.11	3.5	390

Kod Code	Elektrik Girişi Electric Input	Kablo Kesiti Cable Cross Section mm²
EMP.6KE010	230 V. AC 1N PE	3 X 2,5

Kod Code	Ürün Adı Description	Ebatlar Dimension mm			Ağırlık Weight kg	Net Net m³	Güç Power kw	Fiyatı Price Euro
		a	b	c				
EMP.6KE020	4 Pleyt'li Elektrikli Ocak 4 Hot Plate Electric Range	600	635	285	34	0.17	7	645

Kod Code	Elektrik Girişi Electric Input	Kablo Kesiti Cable Cross Section mm²
EMP.6KE020	400 V. AC 3N PE	5 X 2,5



EMP.6KG020+EMP.TS020 EMP.6KE010+EMP.TS010-K

Türkçe

ELEKTRİKLİ OCAKLAR

- 6 kademeli şalter.
- Kolay temizlenebilir ve hijyeniktir.
- Paslanmaz çelik gövde.

Türkçe

GAZLI OCAKLAR

- Lpg ve Ng ile çalışabilme özelliği.
- Magnet emniyet ventilli musluklar.
- Özel emaye kaplı güçlü ızgara.
- Kademeli şalter.
- Çift yanışlı brülör.
- Her brülör için piezzo çakmak ile kontrol.
- Kolay temizlenebilir ve hijyeniktir.
- Paslanmaz çelik gövde.

English

ELECTRIC RANGES

- 6 position switch.
- Easy to clean and hygienic.
- Stainless steel body.

English

GAS RANGES

- Lpg or Natural Gas.
- Magnet safety valves.
- Solid enamelled cast iron.
- Positioned switch.
- Double ring burner.
- Piezo electric ignition system for each module.
- Easy to clean and hygienic.
- Stainless steel body.

Gazlı - Elektrikli Fritözler
 Gas - Electric Fryers

Kod Code	Ürün Adı Description	Ebatlar Dimensions mm			Ağırlık Weight kg	Net Net m³	Güç Power kw	Kapasite Capacity lt	Fiyatı Price Euro
		a	b	c					
EMP.6FE010	Elektrikli Fritöz Electric Fryer	400	635	285	26	0.11	7.2	10	760

Havuz içerisinde 2 adet sepet
2 No's of baskets

Kod Code	Elektrik Girişi Electric Input	Kablo Kesiti Cable Cross Section mm²
EMP.6FE010	400 V. AC 3N PE	5 X 2,5

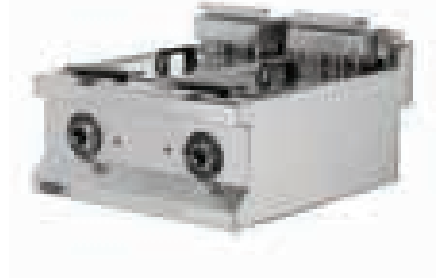

Kod Code	Ürün Adı Description	Ebatlar Dimensions mm			Ağırlık Weight kg	Net Net m³	Güç Power kw	Kapasite Capacity lt	Fiyatı Price Euro
		a	b	c					
EMP.6FE020	Elektrikli Fritöz Electric Fryer	600	635	285	42	0.17	14.4	2x10	1.350

Havuz içerisinde 2 adet sepet
2 No's of baskets in each tank

Kod Code	Elektrik Girişi Electric Input	Kablo Kesiti Cable Cross Section mm²
EMP.6FE020	400 V. AC 3N PE	5 X 2,5



Kod Code	Ürün Adı Description	Ebatlar Dimensions mm			Ağırlık Weight kg	Net Net m³	Güç Power kw	Kapasite Capacity lt	Fiyatı Price Euro
		a	b	c					
EMP.6FG010	Gazlı Fritöz Gas Fryer	400	635	285	25	0.11	7	10	890

Kod Code	Gaz Tüketim Değeri Gas Consumption Ng	Gaz Tüketim Değeri Gas Consumption Lpg
EMP.6FG010	0.74 m³/h	0.49 kg/h



Kod Code	Ürün Adı Description	Ebatlar Dimensions mm			Ağırlık Weight kg	Net Net m³	Güç Power kw	Kapasite Capacity lt	Fiyatı Price Euro
		a	b	c					
EMP.6FG020	Gazlı Fritöz Gas Fryer	800	635	285	32	0.17	14	2x10	1.675

Kod Code	Gaz Tüketim Değeri Gas Consumption Ng	Gaz Tüketim Değeri Gas Consumption Lpg
EMP.6FG020	1.48 m³/h	0.1 kg/h

Türkçe
ELEKTRİKLİ FRİTÖZLER

- Termostatik kontrol.
- Paslanmaz çelik sepetler.
- Hareketli ısıtıcılar kolay temizlik imkanı sağlar.
- Tahliye musluğu ile emniyetli yağ boşaltma.
- Limit termostat.
- Kolay temizlenebilir ve hijyeniktir.
- Paslanmaz çelik gövde.

GAZLI FRİTÖZLER

- Lpg ve Ng ile çalışabilme özelliği.
- Magnet emniyet ventilli musluklar.
- Paslanmaz çelik sepetler.
- Tahliye musluğu ile emniyetli yağ boşaltma.
- Limit termostat.
- Kolay temizlenebilir ve hijyeniktir.
- Paslanmaz çelik gövde.

English
ELECTRIC FRYERS

- Thermostatic controller.
- Stainless steel baskets.
- Moving heaters provide easy cleaning.
- Front oil drainage valve.
- Safety thermostat for overheating protection.
- Easy to clean and hygienic.
- Stainless steel body.

GAS FRYERS

- Lpg or Natural Gas.
- Magnet safety valves.
- Stainless steel baskets.
- Front oil drainage valve.
- Safety thermostat for overheating protection.
- Easy to clean and hygienic.
- Stainless steel body.

Elektrikli Makarna Haşlama-Patates Dinlendirme Electric Pasta Cooker-Chips Scuttle



Kod Code	Ürün Adı Description	Ebatlar Dimensions mm			Ağırlık Weight kg	Net Net m ³	Güç Power kw	Kapasite Capacity	Fiyatı Price Euro
		a	b	c					
EMP.6ME010	Elektrikli Makarna Haşlama Electric Pasta Cooker	400x635x285			26	0.11	4.5	10 lt	925

Kod Code	Elektrik Girişi Electric Input	Kablo Kesiti Cable Cross Section mm ²
EMP.6ME010	400 V. AC 3N PE	5 X 2,5



Kod Code	Ürün Adı Description	Ebatlar Dimensions mm			Ağırlık Weight kg	Net Net m ³	Güç Power kw	Kapasite Capacity lt	Fiyatı Price Euro
		a	b	c					
EMP.6DE010	Patates Dinlendirme Chips Scuttle	400x635x285			18	0.11	0.65	GN 1/1x150 mm	410

Kod Code	Elektrik Girişi Electric Input	Kablo Kesiti Cable Cross Section mm ²
EMP.6DE010	230 V. AC N PE	3 X 1,5



Türkçe

ELEKTRİKLİ MAKARNA HAŞLAMA- PATATES DİNLENDİRME

EMP.6ME010

- Termostatik kontrol.
- Paslanmaz çelik sepetler.
- Su doldurma musluğu.
- Tahliye musluğu ile su boşaltma.
- Taşan su tahliye sistemi.
- Kolay temizlenebilir ve hijyeniktir.
- Paslanmaz çelik gövde.

EMP.6DE010

- Kızartılmış patateslerin sıcak bekletilmesinde ve yağların süzülmesinde kullanılır.
- Infrared seramik ısıtıcı.
- Havuzda kızartma yağının süzülmesi için maksimum verim sağlayan özel form.
- Kolay temizlenebilir ve hijyeniktir.
- Paslanmaz çelik gövde.

English

ELECTRIC PASTA COOKER- CHIPS SCUTTLE

EMP.6ME010

- Thermostatic controller.
- Stainless steel baskets.
- Water filling tap.
- Discharge valve.
- Overflow drainage system.
- Easy to clean and hygienic.
- Stainless steel body.

EMP.6DE010

- Operates in order to keep fries warm and drain oil.
- Infrared ceramic heater.
- Special form on the container, provides maximum efficiency in order to drain oil.
- Easy to clean and hygienic.
- Stainless steel body.

Gazlı Izgaralar
 Gas Grills

Kod Code	Ürün Adı Description	Ebatlar Dimension mm			Ağırlık Weight kg	Net Net m³	Güç Power kw	Fiyatı Price Euro
		a	b	c				
EMP.6IG010	Gazlı Izgara-Düz Gas Grill-Smooth	400	635	285	47	0.11	6.5	560
EMP.6IG010-K	Gazlı Izgara-Krom Tabla Gas Grill-Chrome Plate	400	635	285	47	0.11	6.5	960

Kod Code	Gaz Tüketim Değeri Gas Consumption Ng	Gaz Tüketim Değeri Gas Consumption Lpg
EMP.6IG010	0,68 m³/h	0,43 kg/h



Kod Code	Ürün Adı Description	Ebatlar Dimension mm			Ağırlık Weight kg	Net Net m³	Güç Power kw	Fiyatı Price Euro
		a	b	c				
EMP.6IG020	Gazlı Izgara-Düz Gas Grill-Smooth	600	635	285	64	0.17	13	900
EMP.6IG022	Gazlı Izgara-Düz+Oluklu Gas Grill-Smooth+Ribbed	600	635	285	65	0.17	13	1.010
EMP.6IG020-K	Gazlı Izgara-Krom Tablalı Gas Grill-Chrome Plate	600	635	285	64	0.17	13	1.375
EMP.6IG022-K	Gazlı Izgara-Krom Tablalı Gas Grill-Chrome Plate	600	635	285	65	0.17	13	1.490

 Düz
Smooth

 Düz+Oluklu
Smooth+Ribbed

Kod Code	Gaz Tüketim Değeri Gas Consumption Ng	Gaz Tüketim Değeri Gas Consumption Lpg
EMP.6IG020	1,37 m³/h	0,86 kg/h
EMP.6IG022	1,37 m³/h	0,86 kg/h



Kod Code	Ürün Adı Description	Ebatlar Dimension mm			Ağırlık Weight kg	Net Net m³	Güç Power kw	Fiyatı Price Euro
		a	b	c				
EMP.6IG030	Gazlı Izgara-Düz Gas Grill-Smooth	900	635	285	83	0.24	19.5	1.235
EMP.6IG032	Gazlı Izgara-Düz+Oluklu Gas Grill-Smooth+Ribbed	900	635	285	85	0.24	19.5	1.260
EMP.6IG030-K	Gazlı Izgara-Krom Tablalı Gas Grill-Chrome Plate	900	635	285	83	0.24	19.5	1.975
EMP.6IG032-K	Gazlı Izgara-Krom Tablalı Gas Grill-Chrome Plate	900	635	285	85	0.24	19.5	2.000

 Düz
Smooth

 Düz+Oluklu
Smooth+Ribbed

Kod Code	Gaz Tüketim Değeri Gas Consumption Ng	Gaz Tüketim Değeri Gas Consumption Lpg
EMP.6IG030	2,06 m³/h	1,29 kg/h
EMP.6IG032	2,06 m³/h	1,29 kg/h

Türkçe
GAZLI IZGARALAR

- Lpg ve Ng ile çalışabilme özelliği.
- Magnet emniyet ventilli ve pilotlu musluklar.
- Tam modüllerde iki bölge piştirme.
- Her brülör için piezzo çakmak ile kontrol.
- Çıkarılabilir yağ toplama haznesi.
- Kolay temizlenebilir ve hijyeniktir.
- Paslanmaz çelik gövde.

English
GAS GRILLS

- Lpg or Natural Gas.
- Magnet safety valves with pilot.
- Two separate heating zones.
- Piezoelectric ignition system for each module.
- Removable oil collection drawer.
- Easy to clean and hygienic.
- Stainless steel body.

Elektrikli Izgaralar
Electric Grills



Kod Code	Ürün Adı Description	Ebatlar Dimension mm			Ağırlık Weight kg	Net Net m³	Güç Power kw	Fiyatı Price Euro
		a	b	c				
EMP.6IE010	Elektrikli Izgara-Düz Electric Grill-Smooth	400x635x285			49	0.11	3.6	560
EMP.6IE010-K	Elektrikli Izgara-Krom Tablalı Electric Grill-Chrome Plate	400x635x285			49	0.11	3.6	965

Kod Code	Elektrik Girişi Electric Input	Kablo Kesiti Cable Cross Section mm²
EMP.6IE010	400 V. AC 3N PE	5 X 2,5

Kod Code	Ürün Adı Description	Ebatlar Dimension mm			Ağırlık Weight kg	Net Net m³	Güç Power kw	Fiyatı Price Euro
		a	b	c				
EMP.6IE020	Elektrikli Izgara-Düz Electric Grill-Smooth	600x635x285			66	0.17	7.2	900
EMP.6IE022	Elektrikli Izgara-Düz+Oluklu Electric Grill-Smooth+Ribbed	600x635x285			66	0.17	7.2	1.010
EMP.6IE020-K	Elektrikli Izgara-Krom Tablalı Electric Grill-Chrome Plate	600x635x285			66	0.17	7.2	1.375
EMP.6IE022-K	Elektrikli Izgara-Krom Tablalı Electric Grill-Chrome Plate	600x635x285			66	0.17	7.2	1.490

Kod Code	Elektrik Girişi Electric Input	Kablo Kesiti Cable Cross Section mm²
EMP.6IE020	400 V. AC 3N PE	5 X 2,5
EMP.6IE022	400 V. AC 3N PE	5 X 2,5



Düz
Smooth



Düz+Oluklu
Smooth+Ribbed

Kod Code	Ürün Adı Description	Ebatlar Dimension mm			Ağırlık Weight kg	Net Net m³	Güç Power kw	Fiyatı Price Euro
		a	b	c				
EMP.6IE030	Elektrikli Izgara-Düz Electric Grill-Smooth	900x635x285			74	0.24	10.8	1.235
EMP.6IE032	Elektrikli Izgara-Düz+Oluklu Electric Grill-Smooth+Ribbed	900x635x285			74	0.24	10.8	1.350
EMP.6IE030-K	Elektrikli Izgara-Krom Tablalı Electric Grill-Chrome Plate	900x635x285			74	0.24	10.8	1.975
EMP.6IE032-K	Elektrikli Izgara-Krom Tablalı Electric Grill-Chrome Plate	900x635x285			74	0.24	10.8	2.000

Kod Code	Elektrik Girişi Electric Input	Kablo Kesiti Cable Cross Section mm²
EMP.6IE030	400 V. AC 3N PE	5 X 4
EMP.6IE032	400 V. AC 3N PE	5 X 4



Düz
Smooth



Düz+Oluklu
Smooth+Ribbed



Türkçe

ELEKTRİKLİ IZGARALAR

- Termostatik kontrol.
- Tam modüllerde iki bölgeyi ısıtma.
- Çıkarılabilir yağ toplama haznesi.
- Kolay temizlenebilir ve hijyeniktir.
- Paslanmaz çelik gövde.

English

ELECTRIC GRILLS

- Thermostatic controller.
- Two separate heating zones.
- Removable oil collection drawer
- Easy to clean and hygienic.
- Stainless steel body.

Gazlı Lavataşlı Izgaralar
Gas Lavastone Grills



Kod Code	Ürün Adı Description	Ebatlar Dimension mm			Ağırlık Weight kg	Net Net m³	Güç Power kw	Fiyatı Price Euro
		a	b	c				
EMP.6LG010	Lavataşlı Izgara - Gazlı Lavastone Grills - Gas	400	635	285	46	0.11	6.46	585

Kod Code	Gaz Tüketim Değeri Gas Consumption Ng	Gaz Tüketim Değeri Gas Consumption Lpg
EMP.6LG010	0,68 m³/h	0,43 kg/h



Kod Code	Ürün Adı Description	Ebatlar Dimension mm			Ağırlık Weight kg	Net Net m³	Güç Power kw	Fiyatı Price Euro
		a	b	c				
EMP.6LG020	Lavataşlı Izgara - Gazlı Lavastone Grills - Gas	600	635	285	95	0.17	12.9	900

Kod Code	Gaz Tüketim Değeri Gas Consumption Ng	Gaz Tüketim Değeri Gas Consumption Lpg
EMP.6LG020	1,36 m³/h	0,85 kg/h



Kod Code	Ürün Adı Description	Ebatlar Dimension mm			Ağırlık Weight kg	Net Net m³	Güç Power kw	Fiyatı Price Euro
		a	b	c				
EMP.6LG030	Lavataşlı Izgara - Gazlı Lavastone Grills - Gas	900	635	285	120	0.24	19.38	1.265

Kod Code	Gaz Tüketim Değeri Gas Consumption Ng	Gaz Tüketim Değeri Gas Consumption Lpg
EMP.6LG030	2,04 m³/h	1,29 kg/h

Döküm üst ızgara
Cast iron top

Türkçe

GAZLI LAVATAŞLI IZGARALAR

- Lpg ve Ng ile çalışabilme özelliği.
- Magnet emniyet ventilli ve pilotlu musluklar.
- Tam modüllerde iki bölgeyi ısıtma.
- Her brülör için piezzo çakmak ile kontrol.
- Çıkarılabilir yağ toplama haznesi.
- Kolay temizlenebilir ve hijyeniktir.
- Paslanmaz çelik gövde.

English

GAS LAVASTONE GRILLS

- Lpg or Natural Gas.
- Magnet safety valves with pilot.
- Two separate heating zones.
- Piezoelectric ignition system for each module.
- Removable oil collection drawer.
- Easy to clean and hygienic.
- Stainless steel body.



EMP.6LG020+EMP.TS020-K EMP.6LG030+EMP.TS030

Gazlı Sulu Izgara
Gas Vapor Grill



Kod Code	Ürün Adı Description	Ebatlar Dimension mm			Ağırlık Weight kg	Net Net m³	Güç Power kw	Fiyatı Price Euro
		a	b	c				
EMP.6LG010-S	Gazlı Sulu Izgara Gas Vapor Grill	400x730x285			45	0.11	5.2	730

Kod Code	Gaz Tüketim Değeri Gas Consumption Ng	Gaz Tüketim Değeri Gas Consumption Lpg
EMP.6LG010-S	0,55 m³/h	0,60 kg/h



Kod Code	Ürün Adı Description	Ebatlar Dimension mm			Ağırlık Weight kg	Net Net m³	Güç Power kw	Fiyatı Price Euro
		a	b	c				
EMP.6LG020-S	Gazlı Sulu Izgara Gas Vapor Grill	800x730x285			90	0.17	10.4	1.180

Kod Code	Gaz Tüketim Değeri Gas Consumption Ng	Gaz Tüketim Değeri Gas Consumption Lpg
EMP.6LG020-S	1,10 m³/h	1,20 kg/h



Kod Code	Ürün Adı Description	Ebatlar Dimension mm			Ağırlık Weight kg	Net Net m³	Güç Power kw	Fiyatı Price Euro
		a	b	c				
EMP.6LG030-S	Gazlı Sulu Izgara Gas Vapor Grill	1200x730x285			135	0.25	15.6	1.685

Kod Code	Gaz Tüketim Değeri Gas Consumption Ng	Gaz Tüketim Değeri Gas Consumption Lpg
EMP.6LG030-S	1,65 m³/h	1,80 kg/h

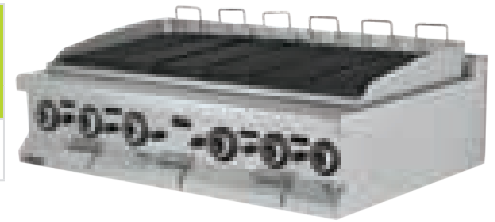

Bu ürün için lütfen 70 seri setaltı dolapları kullanınız.
Please use 70 seri cabinets for this range.

Türkçe

GAZLI SULU IZGARA

- Buharlaştırma kabini sayesinde daha verimli piştirme.
- Lpg ve Ng ile çalışabilme özelliği.
- Magnet emniyet ventilli ve pilotlu musluklar.
- Tam modüllerde iki bölgeyi ısıtma.
- Her brülör için piezzo çakmak ile kontrol.
- Pisk döküm izgara.
- Kolay temizlenebilir ve hijyeniktir.
- Paslanmaz çelik gövde.

English

GAS VAPOR GRILL

- Steamer cabinet provides fertile cooking.
- Lpg or Natural Gas.
- Magnet safety valves with pilot.
- Two separate heating zones.
- Piezoelectric ignition system for each module.
- Cast iron plate.
- Easy to clean and hygienic.
- Stainless steel body.

Elektrikli Benmariler
Electric Bain maries



Kod Code	Ürün Adı Description	Ebatlar Dimension mm			Ağırlık Weight kg	Net Net m³	Güç Power kw	Fiyatı Price Euro
		a	b	c				
EMP.6SE010	Elektrikli Benmari Electric Bain marie	400x635x285			23	0.11	1.5	510

Kod Code	Elektrik Girişi Electric Input	Kablo Kesiti Cable Cross Section mm²
EMP.6SE010	230 V. AC N PE	3 X 1,5



Kod Code	Ürün Adı Description	Ebatlar Dimension mm			Ağırlık Weight kg	Net Net m³	Güç Power kw	Fiyatı Price Euro
		a	b	c				
EMP.6SE020	Elektrikli Benmari Electric Bain marie	600x635x285			32	0.17	3	615

Kod Code	Elektrik Girişi Electric Input	Kablo Kesiti Cable Cross Section mm²
EMP.6SE020	230 V. AC N PE	3 X 2,5

Türkçe

ELEKTRİKLİ BENMARİLER

- Termostatik kontrol.
- Yarım modül 1 adet GN 2/3 + 2 adet GN 1/6 kapasitelidir .
- Tam modül ise 1 adet GN 1/1 + 2 adet 1/4 kapasitelidir.
- Tahliye musluğu.
- Su alma musluğu.
- Kolay temizlenebilir ve hijyeniktir.
- Paslanmaz çelik gövde.

*Standart üretimimizde küvet bulunmamaktadır.

English

ELECTRIC BAIN MARIES

- Thermostatic controller.
- Capacity of half modul ; 1 piece of GN 2/3 + 2 pieces of GN 1/6.
- Capacity of full modul ; 1 piece of GN 1/1 + 2 pieces of 1/4.
- Drainage valve.
- Water inlet valve.
- Easy to clean and hygienic.
- Stainless steel body.

*Standart product does not have containers.

Set Altı ve Ara Tezgahlar Worktop and Undercounter Cabinet



Tablo/Table

Kod Code	Ürün Adı Description	Ebatlar Dimension mm			Ağırlık Weight kg	Net Net m³	Fiyatı Price Euro
		a	b	c			
EMP.6TN010	Ara Tezgah 1/2 Mod Worktop 1/2 Module	400	635	285	15	0.11	165



Kod Code	Ürün Adı Description	Ebatlar Dimension mm			Ağırlık Weight kg	Net Net m³	Fiyatı Price Euro
		a	b	c			
EMP.6TN020	Ara Tezgah / 1 Mod Worktop 1 Module	600	635	285	22	0.17	235



Kod Code	Ürün Adı Description	Ebatlar Dimension mm			Ağırlık Weight kg	Net Net m³	Fiyatı Price Euro
		a	b	c			
EMP.TS010	Set Altı Tezgah - Kapaklı Undercounter Cabinet - With Door	400	570	565	21	0.15	215



Kod Code	Ürün Adı Description	Ebatlar Dimension mm			Ağırlık Weight kg	Net Net m³	Fiyatı Price Euro
		a	b	c			
EMP.TS020	Set Altı Tezgah - Kapaklı Undercounter Cabinet - With Door	600	570	565	30	0.22	310



Kod Code	Ürün Adı Description	Ebatlar Dimension mm			Ağırlık Weight kg	Net Net m³	Fiyatı Price Euro
		a	b	c			
EMP.TS030	Set Altı Tezgah - Kapaklı Undercounter Cabinet - With Door	900	570	565	38	0.33	480



Türkçe

SET ALTI VE ARA TEZGAHLAR

- Tezgahlar 60 seri cihazların altına kullanılabilecek uygun modüler ölçülerdedir.
- Kolay temizlenebilir ve hijyeniktir.
- Paslanmaz çelik gövde.

English

WORKTOP and UNDERCOUNTER CABINET

- Under-Set Counters are suitable to use under each kind of 60's serie equipments.
- Easy to clean and hygienic.
- Stainless steel body.

Set Altı ve Ara Tezgahlar
Worktop and Undercounter Cabinet



Kod Code	Ürün Adı Description	Ebatlar Dimension mm			Ağırlık Weight kg	Net Net m³	Fiyatı Price Euro
		a	b	c			
EMP.TS010-K	Set Altı Tezgah - Kapaksız Undercounter Cabinet - Without Door	400	570	565	21	0.15	175



Kod Code	Ürün Adı Description	Ebatlar Dimension mm			Ağırlık Weight kg	Net Net m³	Fiyatı Price Euro
		a	b	c			
EMP.TS020-K	Set Altı Tezgah - Kapaksız Undercounter Cabinet - Without Door	600	570	565	30	0.22	225

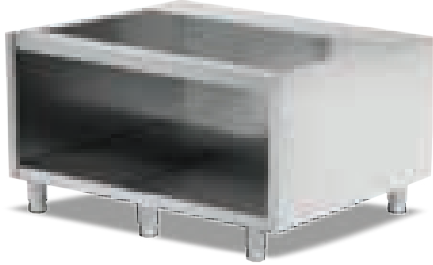

Kod Code	Ürün Adı Description	Ebatlar Dimension mm			Ağırlık Weight kg	Net Net m³	Fiyatı Price Euro
		a	b	c			
EMP.TS030-K	Set Altı Tezgah - Kapaksız Undercounter Cabinet - Without Door	900	570	565	38	0.33	375



700 Serisi 
700 Serie



İş'in Mutfuğu / Kitchen of Business

empero@empero.com.tr



- * **6 Brülör'lü Kuzine - 90 cm / 6 Burner Gas Range with Oven - 90 cm**
- * **Gazlı Ocaklar / Gas Cookers**
- * **Gazlı Wok Ocakları / Gas Wok Ranges**
- * **Elektrikli Ocaklar- Yuvarlak Pleyt / Electric Cookers - Circle Hot Plate**
- * **Elektrikli Ocaklar - Kare Pleyt / Electric Cookers - Square Hot Plate**
- * **Gazlı - Elektrikli Fritözler / Gas - Electric Fryers**
- * **Gazlı Fritözler / Gas Fryers**
- * **Elektrikli Makarna Haşlama - Patates Dinlendirme / Electric Pasta Cooker - Chips Scuttle**
- * **Gazlı Izgaralar / Gas Grills**
- * **Elektrikli Izgaralar / Electric Grills**
- * **Gazlı Lavataşlı Izgaralar / Gas Lavastone Grills**
- * **Elektrikli Sulu Izgaralar / Electric Chargrill**
- * **Gazlı Sulu Izgara / Gas Vapor Grill**
- * **Elektrikli Benmariler / Electric Bain maries**
- * **Ara Tezgahlar / Work Top with Cabinets**
- * **Set Altı Tezgah - Kapaklı / Undercounter Cabinet - With Door**
- * **Set Altı Tezgah - Kapaksız / Undercounter Cabinet - Without Door**
- * **Set Altı Fırınlar - Gazlı / Ovens - Gas**
- * **Set Altı Fırınlar - Elektrikli / Ovens - Electric**
- * **Devrilir Tavalar / Tilting Pans**
- * **Kaynatma Tencereleri (İndirekt) / Boiling Pans (Indirect)**

700 Serisi
700 Serie



6 Brülör'lü Kuzine - 90 cm
6 Burner Gas Range with Oven - 90 cm



Kod Code	Ürün Adı Description	Ebatlar Dimension mm			Net Net m ³	Güç Power kw	Fiyatı Price Euro
		a	b	c			
EMP.7KG031-ING	6 Brülör'lü Kuzine - 90 cm 6 Burner Gas Range with Oven - 90 cm	900	765	945	0.92	47.4	2.300

Kod Code	Gaz Tüketim Değeri Gas Consumption Ng	Gaz Tüketim Değeri Gas Consumption Lpg
EMP.7KG031-ING	4,94 m ³ /h	3,62 kg/h

Türkçe

6 BRÜLÖR'LÜ KUZİNE - 90 CM

- Lpg ve Ng ile çalışabilme özelliği.
- Magnet emniyet ventilli musluklar.
- Darbelere karşı dayanıklı üst döküm.
- Her biri 2x1/1 Gn Kapasiteli fırın kızağı.
- Kolay temizlenebilir ve hijyeniktir.
- Paslanmaz çelik gövde.

English

6 BURNER GAS RANGE WITH OVEN - 90 CM

- Lpg or Natural Gas.
- Magnet safety gas valve and thermocouple.
- Heavy duty top cast iron.
- 2x1/1 Gn Capacity for each shelf.
- Easy to clean and hygienic.
- Stainless steel body.

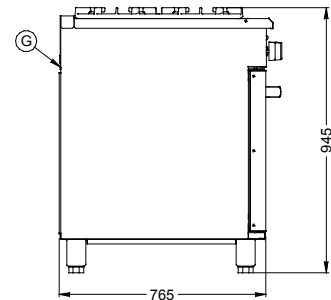
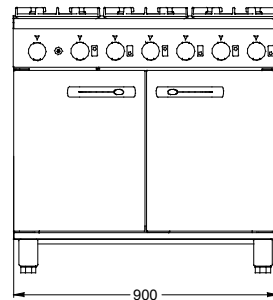
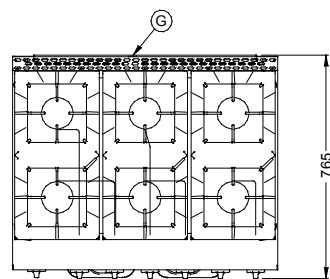
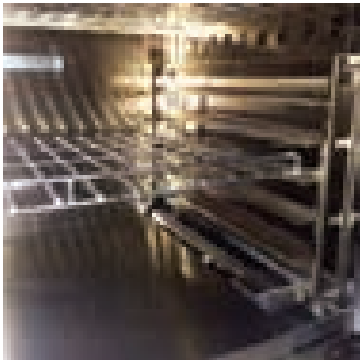



Kod Code	Ürün Adı Description	Ebatlar Dimension mm			Ağırlık Weight kg	Net Net m³	Güç Power kw	Fiyatı Price Euro
		a	b	c				
EMP.7KG010	2 Brülör'lü Gazlı Ocak 2 Burner Gas Cooker	400	730	285	24	0.8	11.5	700

Setüstü / Countertop

Kod Code	Gaz Tüketim Değeri Gas Consumption Ng	Gaz Tüketim Değeri Gas Consumption Lpg
EMP.7KG010	1,21 m³/h	0,90 kg/h



Kod Code	Ürün Adı Description	Ebatlar Dimension mm			Ağırlık Weight kg	Net Net m³	Güç Power kw	Fiyatı Price Euro
		a	b	c				
EMP.7KG020	4 Brülör'lü Gazlı Ocak 4 Burner Gas Cooker	800	730	285	49	0.17	23	1.285

Setüstü / Countertop

Kod Code	Gaz Tüketim Değeri Gas Consumption Ng	Gaz Tüketim Değeri Gas Consumption Lpg
EMP.7KG020	2,42 m³/h	1,80 kg/h



Kod Code	Ürün Adı Description	Ebatlar Dimension mm			Ağırlık Weight kg	Net Net m³	Güç Power kw	Fiyatı Price Euro
		a	b	c				
EMP.7KG030	6 Brülör'lü Gazlı Ocak 6 Burner Gas Cooker	1200	730	285	73	0.25	34.5	1.855

Setüstü / Countertop

Kod Code	Gaz Tüketim Değeri Gas Consumption Ng	Gaz Tüketim Değeri Gas Consumption Lpg
EMP.7KG030	3,63 m³/h	2,70 kg/h

Türkçe
GAZLI OCAKLAR

- Lpg ve Ng ile çalışabilme özelliği.
- Magnet emniyet ventilli musluklar.
- Darbelere karşı dayanıklı üst döküm.
- Kolay temizlenebilir ve hijyeniktir.
- Paslanmaz çelik gövde.

English
GAS COOKERS

- Lpg or Natural Gas.
- Magnet safety gas valve and thermocouple.
- Heavy duty top cast iron.
- Easy to clean and hygienic.
- Stainless steel body.



EMP.7KG030+EMP.7FRG03



EMP.7KG020+EMP.7TS020



EMP.7KG010+EMP.7TS010-K

Gazlı Wok Ocakları
Gas Wok Cookers



Kod Code	Ürün Adı Description	Ebatlar Dimension mm			Ağırlık Weight kg	Net Net m³	Güç Power kw	Fiyatı Price Euro
		a	b	c				
EMP.7WK010	1 Brülörlü Gazlı Wok Ocağı 1 Burner Gas Wok Cooker	400	730	285	36	0.08	18	750

Setüstü / Countertop

Kod Code	Gaz Tüketim Değeri Gas Consumption Ng	Gaz Tüketim Değeri Gas Consumption Lpg
EMP.7WK010	1,90 m³/h	1,5 kg/h



Kod Code	Ürün Adı Description	Ebatlar Dimension mm			Ağırlık Weight kg	Net Net m³	Güç Power kw	Fiyatı Price Euro
		a	b	c				
EMP.7WK020	2 Brülörlü Gazlı Wok Ocağı 2 Burner Gas Wok Cooker	800	730	285	66	0.17	36	1.300

Setüstü / Countertop

Kod Code	Gaz Tüketim Değeri Gas Consumption Ng	Gaz Tüketim Değeri Gas Consumption Lpg
EMP.7WK020	3,8 m³/h	2,10 kg/h

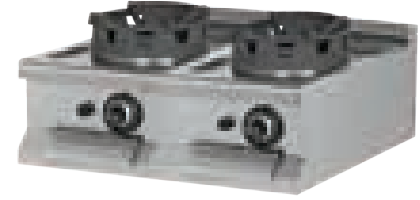

Kod Code	Ürün Adı Description	Ebatlar Dimension mm			Ağırlık Weight kg	Net Net m³	Güç Power kw	Fiyatı Price Euro
		a	b	c				
EMP.7WK030	3 Brülörlü Gazlı Wok Ocağı 3 Burner Gas Wok Cooker	1200	730	285	97	0.25	54	1.900

Setüstü / Countertop

Kod Code	Gaz Tüketim Değeri Gas Consumption Ng	Gaz Tüketim Değeri Gas Consumption Lpg
EMP.7WK030	5,60 m³/h	3,15 kg/h

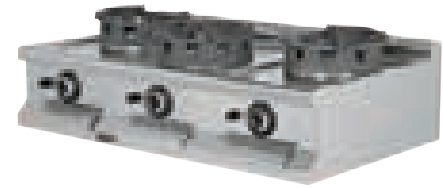

EMP.7WK010+EMP.7TS010

EMP.7WK010+EMP.7TS010-K

Türkçe

GAZLI WOK OCAKLARI

- Lpg ve Ng ile çalışabilme özelliği.
- Magnet emniyet ventilli musluklar.
- Darbelere karşı dayanıklı üst döküm.
- Kolay temizlenebilir ve hijyeniktir.
- Paslanmaz çelik gövde.

English

GAS WOK COOKERS

- Lpg or Natural Gas.
- Magnet safety gas valve and thermocouple.
- Heavy duty top cast iron.
- Easy to clean and hygienic.
- Stainless steel body.

Elektrikli Ocaklar- Yuvarlak Pleyt
 Electric Cookers - Circle Hot Plate

Kod Code	Ürün Adı Description	Ebatlar Dimension mm			Ağırlık Weight kg	Net Net m ³	Güç Power kw	Fiyatı Price Euro
		a	b	c				
EMP.7KE010	2 Pleyt'li Elektrikli Ocak 2 Hot Plate Electric Cooker	400	730	285	20	0.08	4	450

Setüstü / Countertop

Kod Code	Elektrik Girişi Electric Input	Kablo Kesiti Cable Cross Section mm ²
EMP.7KE010	200 V. AC N PE	3 X 2,5



Kod Code	Ürün Adı Description	Ebatlar Dimension mm			Ağırlık Weight kg	Net Net m ³	Güç Power kw	Fiyatı Price Euro
		a	b	c				
EMP.7KE020	4 Pleyt'li Elektrikli Ocak 4 Hot Plate Electric Cooker	800	730	285	41	0.17	8	735

Setüstü / Countertop

Kod Code	Elektrik Girişi Electric Input	Kablo Kesiti Cable Cross Section mm ²
EMP.7KE020	400 V. AC 3N PE	5 X 2,5

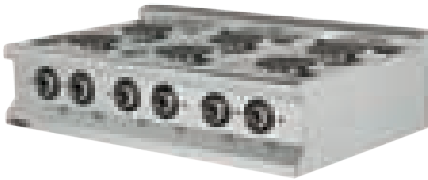

Kod Code	Ürün Adı Description	Ebatlar Dimension mm			Ağırlık Weight kg	Net Net m ³	Güç Power kw	Fiyatı Price Euro
		a	b	c				
EMP.7KE030	6 Pleyt'li Elektrikli Ocak 6 Hot Plate Electric Cooker	1200	730	285	84	0.25	12	1.115

Setüstü / Countertop

Kod Code	Elektrik Girişi Electric Input	Kablo Kesiti Cable Cross Section mm ²
EMP.7KE030	400 V. AC 3N PE	5 X 4

Türkçe
**ELEKTRİKLİ OCAKLAR
YUVARLAK PLEYT**

- 6 kademeli şalter.
- Kolay temizlenebilir ve hijyeniktir.
- Paslanmaz çelik gövde.

English
**ELECTRIC COOKERS - CIRCLE
HOT PLATE**

- 6 position switches
- Easy to clean and hygienic.
- Stainless steel body.



EMP.7KE020+EMP.7TS020-K



EMP.7KE010+EMP.7TS010



EMP.7KE030+EMP.7FRE02

Elektrikli Ocaklar - Kare Pleyt
Electric Cookers - Square Hot Plate

Kod Code	Ürün Adı Description	Ebatlar Dimension mm			Ağırlık Weight kg	Net Net m³	Güç Power kw	Fiyatı Price Euro
		a	b	c				
EMP.7KE010-K	2 Pleyt'li Elektrikli Ocak 2 Hot Plate Electric Cooker	400	730	285	20	0.08	4.5	615



Setüstü / Countertop

Kod Code	Elektrik Girişi Electric Input	Kablo Kesiti Cable Cross Section mm²
EMP.7KE010	200 V. AC N PE	3 X 2,5

Kod Code	Ürün Adı Description	Ebatlar Dimension mm			Ağırlık Weight kg	Net Net m³	Güç Power kw	Fiyatı Price Euro
		a	b	c				
EMP.7KE020-K	4 Pleyt'li Elektrikli Ocak 4 Hot Plate Electric Cooker	800	730	285	41	0.17	9	1.120



Setüstü / Countertop

Kod Code	Elektrik Girişi Electric Input	Kablo Kesiti Cable Cross Section mm²
EMP.7KE020	400 V. AC 3N PE	5 X 2,5

Kod Code	Ürün Adı Description	Ebatlar Dimension mm			Ağırlık Weight kg	Net Net m³	Güç Power kw	Fiyatı Price Euro
		a	b	c				
EMP.7KE030-K	6 Pleyt'li Elektrikli Ocak 6 Hot Plate Electric Cooker	1200	730	285	84	0.25	13.5	1.650



Setüstü / Countertop

Kod Code	Elektrik Girişi Electric Input	Kablo Kesiti Cable Cross Section mm²
EMP.7KE030	400 V. AC 3N PE	5 X 4

Türkçe

ELEKTRİKLİ OCAKLAR - KARE PLEYT

- 6 kademeli şalter.
- Kolay temizlenebilir ve hijyeniktir.
- Paslanmaz çelik gövde.

English

ELECTRIC COOKERS - SQUARE HOT PLATE

- 6 position switches
- Easy to clean and hygienic.
- Stainless steel body.

Gazlı - Elektrikli Fritözler
 Gas - Electric Fryers

Kod Code	Ürün Adı Description	Ebatlar Dimension mm			Ağırlık Weight kg	Net Net m³	Güç Power kw	Kapasite Capacity lt	Fiyatı Price Euro
		a	b	c					
EMP.7FE010	Elektrikli Fritöz Electric Fryer	400	730	285	23	0.08	11	18	900

Setüstü / Countertop

Havuz içerisinde 2 adet sepet
2 No's of baskets

Kod Code	Elektrik Girişi Electric Input	Kablo Kesiti Cable Cross Section mm²
EMP.7FE010	400 V. AC 3N PE	5 X 4

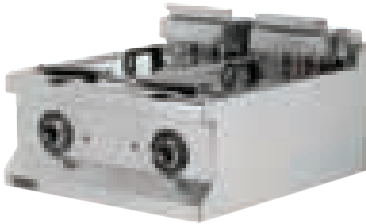

Kod Code	Ürün Adı Description	Ebatlar Dimension mm			Ağırlık Weight kg	Net Net m³	Güç Power kw	Kapasite Capacity lt	Fiyatı Price Euro
		a	b	c					
EMP.7FE020	Elektrikli Fritöz Electric Fryer	800	730	285	51	0.17	2x18	1.665	

Setüstü / Countertop

Havuz içerisinde 2 adet sepet
2 No's of baskets in each tank

Kod Code	Elektrik Girişi Electric Input	Kablo Kesiti Cable Cross Section mm²
EMP.7FE020	400 V. AC 3N PE	5 X 4



Kod Code	Ürün Adı Description	Ebatlar Dimension mm			Ağırlık Weight kg	Net Net m³	Güç Power kw	Kapasite Capacity lt	Fiyatı Price Euro
		a	b	c					
EMP.7FG010-S	Gazlı Fritöz Gas Fryer	400	730	285	23	0.08	7	12	1.050

Setüstü / Countertop

Kod Code	Gaz Tüketim Değeri Gas Consumption Ng	Gaz Tüketim Değeri Gas Consumption Lpg
EMP.7FG010-S	0,74 m³/h	0,49 kg/h



Kod Code	Ürün Adı Description	Ebatlar Dimension mm			Ağırlık Weight kg	Net Net m³	Güç Power kw	Kapasite Capacity lt	Fiyatı Price Euro
		a	b	c					
EMP.7FG020-S	Gazlı Fritöz Gas Fryer	800	730	285	51	0.17	14	2x12	1.875

Setüstü / Countertop

Kod Code	Gaz Tüketim Değeri Gas Consumption Ng	Gaz Tüketim Değeri Gas Consumption Lpg
EMP.7FG020-S	1,48 m³/h	0,98 kg/h

Türkçe
GAZLI FRİTÖZLER

- Lpg ve Ng ile çalışabilme özelliği.
- Magnet emniyet ventilli musluklar.
- Paslanmaz çelik sepetler.
- Tahliye musluğu ile emniyetli yağ boşaltma.
- Limit termostat.
- Kolay temizlenebilir ve hijyeniktir.
- Paslanmaz çelik gövde.

ELEKTRİKLİ FRİTÖZLER

- Termostatik kontrol.
- Paslanmaz çelik sepetler.
- Hareketli ısıtıcılar kolay temizlik imkanı sağlar.
- Tahliye musluğu ile emniyetli yağ boşaltma.
- Limit termostat.
- Kolay temizlenebilir ve hijyeniktir.
- Paslanmaz çelik gövde.

English
GAS FRYERS

- Lpg or Natural Gas.
- Magnet safety valves.
- Stainless steel baskets.
- Front oil drainage valve.
- Safety thermostat for overheating protection.
- Easy to clean and hygienic.
- Stainless steel body.

ELECTRIC FRYERS

- Thermostatic control.
- Stainless steel baskets.
- Moving heaters provide easy cleaning.
- Safe oil drainage from the bottom via valve.
- Safety thermostat for overheating protection.
- Easy to clean and hygienic.
- Stainless steel body.

Gazlı Fritözler
Gas Fryers



Kod Code	Ürün Adı Description	Ebatlar Dimension mm			Ağırlık Weight kg	Net Net m³	Güç Power kw	Kapasite Capacity lt	Fiyatı Price Euro
		a	b	c					
EMP.7FG010	Gazlı Fritöz Gas Fryer	400	730	850	63	0.26	11.63	18	1.180

Dolaplı / With Cupboard

Kod Code	Gaz Tüketim Değeri Gas Consumption Ng	Gaz Tüketim Değeri Gas Consumption Lpg
EMP.7FG010	1,22 m³/h	0,61 kg/h

Kod Code	Ürün Adı Description	Ebatlar Dimension mm			Ağırlık Weight kg	Net Net m³	Güç Power kw	Kapasite Capacity lt	Fiyatı Price Euro
		a	b	c					
EMP.7FG020	Gazlı Fritöz Gas Fryer	800	730	850	96	0.52	23.25	2x18	2.250

Dolaplı / With Cupboard

Kod Code	Gaz Tüketim Değeri Gas Consumption Ng	Gaz Tüketim Değeri Gas Consumption Lpg
EMP.7FG020	2,45 m³/h	1,22 kg/h



Türkçe

GAZLI FRİTÖZLER

- Lpg ve Ng ile çalışabilme özelliği.
- 220 V 50 Hz çalışma voltajı.
- Termostatik kumanda.
- Paslanmaz çelik sepetler.
- Magnet emniyet ventilli musluklar.
- Boşaltma borusu ile emniyetli yağ boşaltma.
- Limit termostat.
- Kolay temizlenebilir ve hijyeniktir.
- Paslanmaz çelik gövde.

English

GAS FRYERS

- Lpg or Natural Gas
- Operating voltage: 220 V 50 Hz
- Thermostatic control.
- Stainless steel baskets.
- Magnet safety gas valve and thermocouple.
- Safe oil drainage from the bottom via valve.
- Safety thermostat for overheating protection.
- Easy to clean and hygienic.
- Stainless steel body.

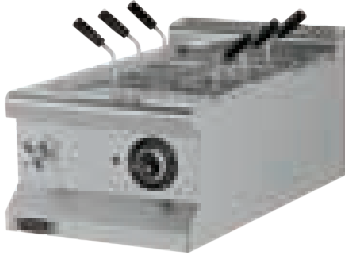

Elektrikli Makarna Haşlama - Patates Dinlendirme
 Electric Pasta Cooker - Chips Scuttle

Kod Code	Ürün Adı Description	Ebatlar Dimension mm			Ağırlık Weight kg	Net Net m ³	Güç Power kw	Fiyatı Price Euro
		a	b	c				
EMP.7ME010	Elektrikli Makarna Haşlama Electric Pasta Cooker	400	730	285	20	0.08	10.5	1.100

Setüstü / Countertop

Kod Code	Elektrik Girişi Electric Input	Kablo Kesiti Cable Cross Section mm ²
EMP.7ME010	400 V. AC 3N PE	5 X 4



Kod Code	Ürün Adı Description	Ebatlar Dimension mm			Ağırlık Weight kg	Net Net m ³	Güç Power kw	Kapasite Capacity	Fiyatı Price Euro
		a	b	c					
EMP.7DE010	Patates Dinlendirme Chips Scuttle	400	730	285	15	0.26	0.08	GN 1/1X150 mm	450

Setüstü / Countertop

Kod Code	Elektrik Girişi Electric Input	Kablo Kesiti Cable Cross Section mm ²
EMP.7DE010	230 V. AC N PE	3 X 1,5

Türkçe
ELEKTRİKLİ MAKARNA HAŞLAMA

- Termostatik kontrol.
- Paslanmaz çelik sepetler.
- Su doldurma musluğu.
- Tahliye musluğu ile su boşaltma.
- Taşan su tahliye sistemi.
- Kolay temizlenebilir ve hijyeniktir.
- Paslanmaz çelik gövde.

PATATES DİNLENDİRME

- Kızartılmış patateslerin sıcak bekletilmesinde ve yağların süzülmesinde kullanılır.
- Infrared seramik ısıtıcı.
- Havuzda kızartma yağının süzülmesi için maksimum verim sağlayan özel form.
- Kolay temizlenebilir ve hijyeniktir.
- Paslanmaz çelik gövde.

English
ELECTRIC PASTA COOKER

- Thermostatic control.
- Stainless steel baskets.
- Water filling tap.
- Discharge valve.
- Overflow drainage system.
- Easy to clean and hygienic.
- Stainless steel body.

CHIPS SCUTTLE

- Operates in order to keep fries warm and drain oil.
- Infrared ceramic heater.
- Special form on the container, provides maximum efficiency in order to drain oil.
- Easy to clean and hygienic.
- Stainless steel body.



EMP.7ME010+EMP.7TS010-K EMP.7DE010+EMP.7TS010

Gazlı Izgaralar
Gas Grills



Kod Code	Ürün Adı Description	Ebatlar Dimension mm			Ağırlık Weight kg	Net Net m³	Güç Power kw	Fiyatı Price Euro
		a	b	c				
EMP.7IG010	Gazlı Izgara-Düz Gas Grill-Smooth	400	730	285	40	0.08	7.1	615
EMP.7IG010-K	Gazlı Izgara-Krom Tablalı Gas Grill-Chrome Plate	400	730	285	40	0.08	7.1	1.050



Setüstü / Countertop

Kod Code	Gaz Tüketim Değeri Gas Consumption Ng	Gaz Tüketim Değeri Gas Consumption Lpg
EMP.7IG010	0,75 m³/h	0,52 kg/h

Kod Code	Ürün Adı Description	Ebatlar Dimension mm			Ağırlık Weight kg	Net Net m³	Güç Power kw	Fiyatı Price Euro
		a	b	c				
EMP.7IG020	Gazlı Izgara-Düz Gas Grill-Smooth	800	730	285	60	0.17	14.2	990
EMP.7IG022	Gazlı Izgara-Düz+Oluklu Gas Grill-Smooth+Ribbed	800	730	285	60	0.17	14.2	1.070
EMP.7IG020-K	Gazlı Izgara-Krom Tablalı Gas Grill-Chrome Plate	800	730	285	60	0.17	14.2	1.560
EMP.7IG022-K	Gazlı Izgara-Krom Tablalı Gas Grill-Chrome Plate	800	730	285	60	0.17	14.2	1.650



Setüstü / Countertop

Kod Code	Gaz Tüketim Değeri Gas Consumption Ng	Gaz Tüketim Değeri Gas Consumption Lpg
EMP.7IG020	1,50 m³/h	1,04 kg/h

Kod Code	Ürün Adı Description	Ebatlar Dimension mm			Ağırlık Weight kg	Net Net m³	Güç Power kw	Fiyatı Price Euro
		a	b	c				
EMP.7IG030	Gazlı Izgara-Düz Gas Grill-Smooth	1200	730	285	100	0.24	21.3	1.490
EMP.7IG032	Gazlı Izgara-Düz+Oluklu Gas Grill-Smooth+Ribbed	1200	730	285	100	0.24	21.3	1.570
EMP.7IG030-K	Gazlı Izgara-Krom Tablalı Gas Grill-Chrome Plate	1200	730	285	100	0.24	21.3	2.060
EMP.7IG032-K	Gazlı Izgara-Krom Tablalı Gas Grill-Chrome Plate	1200	730	285	100	0.24	21.3	2.150



Setüstü / Countertop

Kod Code	Gaz Tüketim Değeri Gas Consumption Ng	Gaz Tüketim Değeri Gas Consumption Lpg
EMP.7IG030	2,15 m³/h	1,56 kg/h



Düz
Smooth

Düz+Oluklu
Smooth+Ribbed

Türkçe

GAZLI IZGARALAR

- Lpg ve Ng ile çalışabilme özelliği.
- Magnet emniyet ventilli ve pilotlu musluklar.
- Tam modüllerde iki bölgeyi ısıtma.
- Her brülör için piezo çakmak ile kontrol.
- Çıkarılabilir yağ toplama haznesi.
- Kolay temizlenebilir ve hijyeniktir.
- Paslanmaz çelik gövde.

English

GAS GRILLS

- Lpg or Natural Gas.
- Magnet safety gas valve and pilot flame.
- Two separate heating zones.
- Piezoelectric ignition system for each burner.
- Removable oil collection drawer.
- Easy to clean and hygienic.
- Stainless steel body.

Elektrikli Izgaralar
 Electric Grills

Kod Code	Ürün Adı Description	Ebatlar Dimension mm			Ağırlık Weight kg	Net Net m ³	Güç Power kw	Fiyatı Price Euro
		a	b	c				
EMP.71E010	Elektrikli Izgara-Düz Electric Grill-Smooth	400	730	285	45	0.08	3.6	645
EMP.71E010-K	Elektrikli Izgara-Krom Tablalı Electric Grill-Chrome Plate	400	730	285	45	0.08	3.6	1.070

Setüstü / Countertop

Kod Code	Elektrik Girişi Electric Input	Kablo Kesiti Cable Cross Section mm ²
EMP.71E010	400 V. AC 3N PE	5 X 2,5

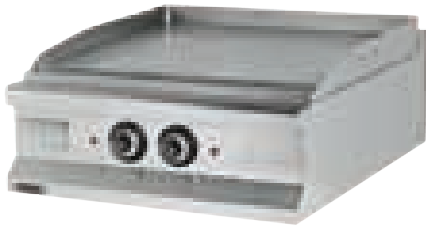

Kod Code	Ürün Adı Description	Ebatlar Dimension mm			Ağırlık Weight kg	Net Net m ³	Güç Power kw	Fiyatı Price Euro
		a	b	c				
EMP.71E020	Elektrikli Izgara-Düz Electric Grill-Smooth	800	730	285	70	0.17	7.2	1.100
EMP.71E022	Elektrikli Izgara-Düz+Oluklu Electric Grill-Smooth+Ribbed	800	730	285	70	0.17	7.2	1.175
EMP.71E020-K	Elektrikli Izgara-Krom Tablalı Electric Grill-Chrome Plate	800	730	285	70	0.17	7.2	1.675
EMP.71E022-K	Elektrikli Izgara-Krom Tablalı Electric Grill-Chrome Plate	800	730	285	70	0.17	7.2	1.750

Setüstü / Countertop

Kod Code	Elektrik Girişi Electric Input	Kablo Kesiti Cable Cross Section mm ²
EMP.71E020	400 V. AC 3N PE	5 X 2,5

 Düz
Smooth

 Düz+Oluklu
Smooth+Ribbed

Kod Code	Ürün Adı Description	Ebatlar Dimension mm			Ağırlık Weight kg	Net Net m ³	Güç Power kw	Fiyatı Price Euro
		a	b	c				
EMP.71E030	Elektrikli Izgara-Düz Electric Grill-Smooth	1200	730	285	100	0.24	21.3	1.600
EMP.71E032	Elektrikli Izgara-Düz+Oluklu Electric Grill-Smooth+Ribbed	1200	730	285	100	0.24	21.3	1.675
EMP.71E030-K	Elektrikli Izgara-Krom Tablalı Electric Grill-Chrome Plate	1200	730	285	100	0.24	21.3	2.175
EMP.71E032-K	Elektrikli Izgara-Krom Tablalı Electric Grill-Chrome Plate	1200	730	285	100	0.24	21.3	2.250

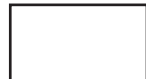
 Düz
Smooth

 Düz+Oluklu
Smooth+Ribbed

Kod Code	Elektrik Girişi Electric Input	Kablo Kesiti Cable Cross Section mm ²
EMP.71E030	400 V. AC 3N PE	5 X 2,5

Türkçe
ELEKTRİKLİ IZGARALAR

- Termostatik kumanda.
- Tam modüllerde iki bölgeyi ısıtma.
- Çıkarılabilir yağ toplama haznesi
- Kolay temizlenebilir ve hijyeniktir.
- Paslanmaz çelik gövde.

English
ELECTRIC GRILLS

- Thermostatic control.
- Two separate heating zones.
- Removable oil collection drawer.
- Easy to clean and hygienic.
- Stainless steel body.

Gazlı Lavataşlı Izgaralar
Gas Lavastone Grills



Kod Code	Ürün Adı Description	Ebatlar Dimension mm			Ağırlık Weight kg	Net Net m³	Güç Power kw	Fiyatı Price Euro
		a	b	c				
EMP.7LG010	Gazlı Lavataşlı Izgaralar Gas Lavastone Grills	400	730	285	45	0.08	8.6	640

Setüstü / Countertop

Kod Code	Gaz Tüketim Değeri Gas Consumption Ng	Gaz Tüketim Değeri Gas Consumption Lpg
EMP.7LG010	0,91 m³/h	0,77 kg/h



Kod Code	Ürün Adı Description	Ebatlar Dimension mm			Ağırlık Weight kg	Net Net m³	Güç Power kw	Fiyatı Price Euro
		a	b	c				
EMP.7LG020	Gazlı Lavataşlı Izgaralar Gas Lavastone Grills	800	730	285	65	0.17	17.2	1.100

Setüstü / Countertop

Kod Code	Gaz Tüketim Değeri Gas Consumption Ng	Gaz Tüketim Değeri Gas Consumption Lpg
EMP.7LG020	1,82 m³/h	0,86 kg/h

Döküm üst izgara
Cast iron top

Kod Code	Ürün Adı Description	Ebatlar Dimension mm			Ağırlık Weight kg	Net Net m³	Güç Power kw	Fiyatı Price Euro
		a	b	c				
EMP.7LG030	Gazlı Lavataşlı Izgaralar Gas Lavastone Grills	1200	730	285	130	0.24	25.8	1.700

Setüstü / Countertop

Kod Code	Gaz Tüketim Değeri Gas Consumption Ng	Gaz Tüketim Değeri Gas Consumption Lpg
EMP.7LG030	2,73 m³/h	1,29 kg/h

Döküm üst izgara
Cast iron top



Türkçe

GAZLI LAVATAŞLI IZGARALAR

- Lpg ve Ng ile çalışabilme özelliği.
- Magnet emniyet ventili ve pilotlu musluklar.
- Tam modüllerde iki bölge ısıtma.
- Her brülör için piezo çakmak ile kontrol.
- Çıkarılabilir yağ toplama haznesi.
- Kolay temizlenebilir ve hijyeniktir.
- Paslanmaz çelik gövde.

English

GAS LAVASTONE GRILLS

- Lpg or Natural Gas.
- Safety gas valve and pilot flame.
- Two separate heating zones.
- Piezoelectric ignition system for each burner.
- Removable oil collection drawer.
- Easy to clean and hygienic.
- Stainless steel body.

NEW

Elektrikli Sulu Izgaralar
Electric Chargrill



Kod Code	Ürün Adı Description	Ebatlar Dimension mm			Ağırlık Weight kg	Net Net m³	Güç Power kw	Fiyatı Price Euro
		a	b	c				
EMP.7LE010	Elektrikli Sulu Izgaralar Electric Chargrill	400x730x285			45	0.08	3.75	1.800



Kod Code	Ürün Adı Description	Ebatlar Dimension mm			Ağırlık Weight kg	Net Net m³	Güç Power kw	Fiyatı Price Euro
		a	b	c				
EMP.7LE020	Elektrikli Sulu Izgaralar Electric Chargrill	800x730x285			75	0.17	8.75	2.350



Kod Code	Ürün Adı Description	Ebatlar Dimension mm			Ağırlık Weight kg	Net Net m³	Güç Power kw	Fiyatı Price Euro
		a	b	c				
EMP.7LE030	Elektrikli Sulu Izgaralar Electric Chargrill	1200x730x285			105	0.24	13.75	2.550

Türkçe

ELEKTRİKLİ SULU IZGARALAR

- Buharlaştırma kabini sayesinde daha verimli pişirme.
- Kolay kaldırılabilir rezistanslar sayesinde kolay temizlik imkanı.
- Daha kısa sürede daha az enerji ile pişirme imkanı.
- Kolay temizlenebilir ve hijyeniktir.
- Paslanmaz çelik gövde.

English

ELECTRIC CHARGRILL

- Steamer cabinet provides fertile cooking.
- Easy tilting heaters provide easy cleaning.
- Faster cooking with low energy.
- Easy to clean and hygienic.
- Stainless steel body.



Gazlı Sulu Izgara
Gas Vapor Grill

Kod Code	Ürün Adı Description	Ebatlar Dimension mm			Ağırlık Weight kg	Net Net m ³	Güç Power kw	Fiyatı Price Euro
		a	b	c				
EMP.7LG010-S	Gazlı Sulu Izgara Gas Vapor Grill	400x730x285			50	0.08	5.2	735

Setüstü / Countertop

Kod Code	Gaz Tüketim Değeri Gas Consumption Ng	Gaz Tüketim Değeri Gas Consumption Lpg
EMP.7LG010-S	0,55 m ³ /h	0,60 kg/h

Kod Code	Ürün Adı Description	Ebatlar Dimension mm			Ağırlık Weight kg	Net Net m ³	Güç Power kw	Fiyatı Price Euro
		a	b	c				
EMP.7LG020-S	Gazlı Sulu Izgara Gas Vapor Grill	800x730x285			90	0.17	10.4	1.175

Setüstü / Countertop

Kod Code	Gaz Tüketim Değeri Gas Consumption Ng	Gaz Tüketim Değeri Gas Consumption Lpg
EMP.7LG020-S	1,10 m ³ /h	1,20 kg/h

Kod Code	Ürün Adı Description	Ebatlar Dimension mm			Ağırlık Weight kg	Net Net m ³	Güç Power kw	Fiyatı Price Euro
		a	b	c				
EMP.7LG030-S	Gazlı Sulu Izgara Gas Vapor Grill	1200x730x285			140	0.78	15.6	1.685

Setüstü / Countertop

Kod Code	Gaz Tüketim Değeri Gas Consumption Ng	Gaz Tüketim Değeri Gas Consumption Lpg
EMP.7LG030-S	1,65 m ³ /h	1,80 kg/h

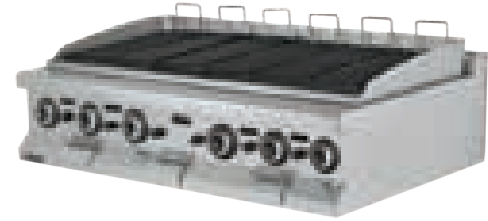

Türkçe

GAZLI SULU IZGARA

- Buharlaştırma kabini sayesinde daha verimli pişirme.
- Lpg ve Ng ile çalışabilme özelliği.
- Magnet emniyet ventilli ve pilotlu musluklar.
- Tam modüllerde iki bölgeyi ısıtma.
- Her brülör için piezo çakmak ile kontrol.
- Pik döküm ızgara.
- Kolay temizlenebilir ve hijyeniktir.
- Paslanmaz çelik gövde.

English

GAS VAPOR GRILL

- Steamer cabinet provides fertile cooking.
- Lpg or Natural Gas.
- Magnet safety gas valve and pilot flame.
- Two separate heating zones.
- Piezoelectric ignition system for each burner.
- Cast iron plate.
- Easy to clean and hygienic.
- Stainless steel body.

Elektrikli Benmariler
 Electric Bain maries

Kod Code	Ürün Adı Description	Ebatlar Dimension mm			Ağırlık Weight kg	Net Net m ³	Güç Power kw	Fiyatı Price Euro
		a	b	c				
EMP.7SE010	Elektrikli Benmari Electric Bain marie	400	730	285	15	0.08	1.5	545

Setüstü / Countertop

Kod Code	Elektrik Girişi Electric Input	Kablo Kesiti Cable Cross Section mm ²
EMP.7SE010	230 V. AC N PE	3 X 1,5

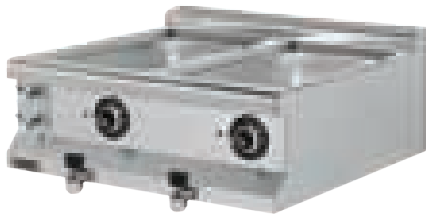

Kod Code	Ürün Adı Description	Ebatlar Dimension mm			Ağırlık Weight kg	Net Net m ³	Güç Power kw	Fiyatı Price Euro
		a	b	c				
EMP.7SE020	Elektrikli Benmari Electric Bain marie	800	730	285	33	0.17	3	910

Setüstü / Countertop

Kod Code	Elektrik Girişi Electric Input	Kablo Kesiti Cable Cross Section mm ²
EMP.7SE020	230 V. AC N PE	3 X 2,5

Türkçe
ELEKTRİKLİ BENMARİLER

- Termostatik kumanda.
- Yarım modül de 1 adet GN1/1.
- Tam modül de ise 2 adet GN1/1.
- Tahliye musluğu.
- Su alma musluğu.
- Kolay temizlenebilir ve hijyeniktir.
- Paslanmaz çelik gövde.

*Standart üretimimizde küvet bulunmamaktadır.

English
ELECTRIC BAIN MARIES

- Thermostatic control.
- Capacity of half modul ; 1 piece of GN1/1.
- Capacity of full modul ; 2 pieces of GN1/1.
- Drainage valve.
- Water inlet valve.
- Easy to clean and hygienic.
- Stainless steel body.

*Standart product does not have containers.



EMP.7SE020+EMP.7TS020



EMP.7SE010+EMP.7TS010-K

Ara Tezgahlar
Work Top



Tablo/Table

Kod Code	Ürün Adı Description	Ebatlar Dimension mm			Ağırlık Weight kg	Net Net m³	Fiyatı Price Euro
		a	b	c			
EMP.7TN010	Ara Tezgah Work Top	400x730x285			15	0.08	250

Setüstü / Countertop



Kod Code	Ürün Adı Description	Ebatlar Dimension mm			Ağırlık Weight kg	Net Net m³	Fiyatı Price Euro
		a	b	c			
EMP.7TN020	Ara Tezgah Work Top	800x730x285			32	0.17	425

Setüstü / Countertop

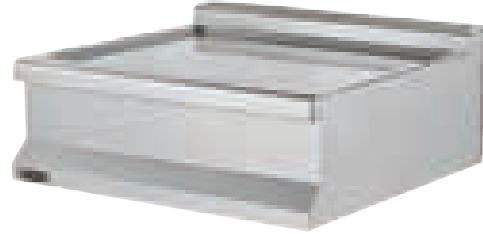

Türkçe

ARA TEZGAHLAR

- Tezgah üst yüzeyleri ara ya da ön hazırlıklar için idealdir.
- Kolay temizlenebilir ve hijyeniktir.
- Paslanmaz çelik gövde.

English

WORK TOP

- Provides preliminary preparation by upper surfaces.
- Easy to clean and hygienic.
- Stainless steel body.

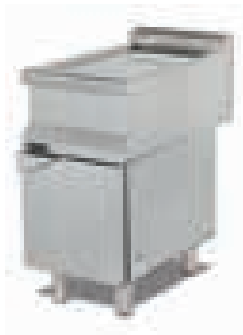

Set Altı Tezgah - Kapaklı
Undercounter Cabinet - With Door



Kod Code	Ürün Adı Description	Ebatlar Dimension mm			Ağırlık Weight kg	Net Net m³	Fiyatı Price Euro
		a	b	c			
EMP.7TS010	Set Altı Tezgah - Kapaklı Undercounter Cabinet - With Door	400	680	565	21	0.14	225



Kod Code	Ürün Adı Description	Ebatlar Dimension mm			Ağırlık Weight kg	Net Net m³	Fiyatı Price Euro
		a	b	c			
EMP.7TS020	Set Altı Tezgah - Kapaklı Undercounter Cabinet - With Door	800	680	565	30	0.27	320



Kod Code	Ürün Adı Description	Ebatlar Dimension mm			Ağırlık Weight kg	Net Net m³	Fiyatı Price Euro
		a	b	c			
EMP.7TS030	Set Altı Tezgah - Kapaklı Undercounter Cabinet - With Door	1200	680	565	38	0.41	510

Set Altı Tezgah - Kapaksız
Undercounter Cabinet - Without Door



Kod Code	Ürün Adı Description	Ebatlar Dimension mm			Ağırlık Weight kg	Net Net m³	Fiyatı Price Euro
		a	b	c			
EMP.7TS010-K	Set Altı Tezgah - Kapaksız Undercounter Cabinet - Without Door	400x680x565			21	0.14	190



Kod Code	Ürün Adı Description	Ebatlar Dimension mm			Ağırlık Weight kg	Net Net m³	Fiyatı Price Euro
		a	b	c			
EMP.7TS020-K	Set Altı Tezgah - Kapaksız Undercounter Cabinet - Without Door	800x680x565			30	0.27	235

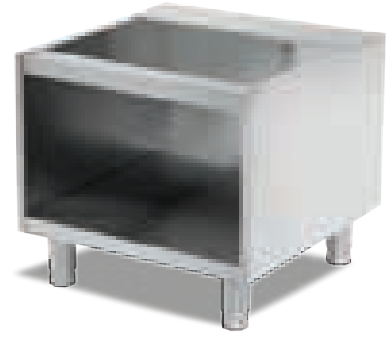

Kod Code	Ürün Adı Description	Ebatlar Dimension mm			Ağırlık Weight kg	Net Net m³	Fiyatı Price Euro
		a	b	c			
EMP.7TS030-K	Set Altı Tezgah - Kapaksız Undercounter Cabinet - Without Door	1200x680x565			38	0.41	390

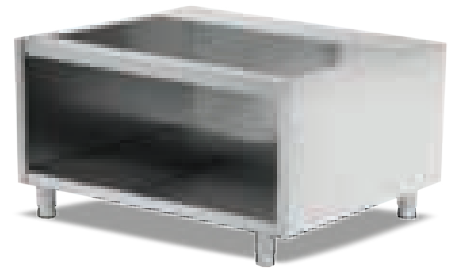

Set Altı Fırınlar - Gazlı
 Ovens - Gas

Kod Code	Ürün Adı Description	Ebatlar Dimension mm			Ağırlık Weight kg	Net Net m ³	Güç Power kw	Fiyatı Price Euro
		a	b	c				
EMP.7FRG01	Set Altı Fırınlar - Gazlı Ovens - Gas	800	680	565	50	0.27	6.46	950

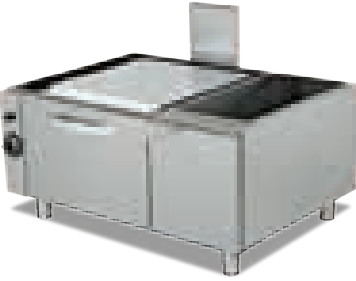

Kod Code	Ürün Adı Description	Ebatlar Dimension mm			Ağırlık Weight kg	Net Net m ³	Güç Power kw	Fiyatı Price Euro
		a	b	c				
EMP.7FRG02	Set Altı Fırınlar - Gazlı Ovens - Gas	1200	680	565	70	0.41	6.46	1.150



Kod Code	Ürün Adı Description	Ebatlar Dimension mm			Ağırlık Weight kg	Net Net m ³	Güç Power kw	Fiyatı Price Euro
		a	b	c				
EMP.7FRG03	Set Altı Maxi Fırınlar - Gazlı Maxi Ovens - Gas	1200	680	565	80	0.41	12.93	1.400

Türkçe
SET ALTI FIRINLAR - GAZLI

- Lpg ve Ng ile çalışabilme özelliği.
- 2xGN 2/1 tepsi kapasiteli paslanmaz çelik fırın iç haznesi.
- Termostatik ayarlı fırın gaz ventili.

English
OVENS - GAS

- Lpg or Natural Gas.
- 2xGN 2/1 capacity, stainless steel internal chamber.
- For oven: temperature control with thermostatic gas valve.

Set Altı Fırınlar - Elektrikli
Ovens - Electric



Kod Code	Ürün Adı Description	Ebatlar Dimension mm			Ağırlık Weight kg	Net Net m ³	Güç Power kw	Fiyatı Price Euro
		a	b	c				
EMP.7FRE01	Set Altı Fırınlar - Elektrikli Ovens - Electric	800	680	565	50	0.27	9	830



Kod Code	Ürün Adı Description	Ebatlar Dimension mm			Ağırlık Weight kg	Net Net m ³	Güç Power kw	Fiyatı Price Euro
		a	b	c				
EMP.7FRE02	Set Altı Fırınlar - Elektrikli Ovens - Electric	1200	680	565	70	0.41	9	940



Kod Code	Ürün Adı Description	Ebatlar Dimension mm			Ağırlık Weight kg	Net Net m ³	Güç Power kw	Fiyatı Price Euro
		a	b	c				
EMP.7FRE03	Set Altı Maxi Fırınlar - Elektrikli Maxi Ovens - Electric	1200	680	565	80	0.41	15	1.235



Türkçe

SET ALTI FIRINLAR - ELEKTRİKLİ

- 2xGN 2/1 tepsi kapasiteli paslanmaz çelik fırın iç haznesi.

English

OVENS - ELECTRIC

- 2xGN 2/1 capacity, stainless steel internal chamber.

Devrilir Tavalar
Tilting Pans

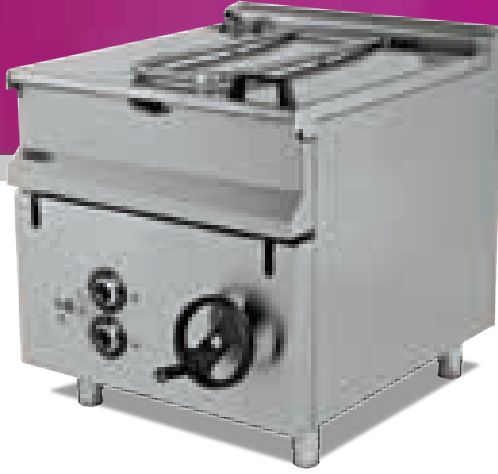

Kod Code	Ürün Adı Description	Ebatlar Dimension mm			Ağırlık Weight kg	Net Net m ³	Güç Power kw	Kapasite Capacity lt	Fiyatı Price Euro
		a	b	c					
EMP.DTG.50	Devrilir Tava (Gazlı) Tilting Pan (Gas)	800x730x850			125	0.70	11.2	50	2.530
EMP.DTE.50	Devrilir Tava (Elektrikli) Tilting Pan (Electrical)	800x730x850			138	0.70	9	50	2.530

Kod Code	Elektrik Girişi Electric Input V	Kablo Kesiti Cable Cross Section mm ²
EMP.DTE.50	380	5x4

Kod Code	Gaz Tüketim Değeri Gas Consumption Ng	Gaz Tüketim Değeri Gas Consumption Lpg
EMP.DTG.50	1,18 m ³ /h	0,68 kg/h

Türkçe

DEVİRİLİR TAVALAR (GAZLI)

- Lpg ve Ng ile çalışabilme özelliği.
- Magnet emniyet ventilli termokulp ve termostat.
- Manuel kaldırma mekanizması.
- Karşı ağırlıklı kapak.
- Güvenlik sensörü.
- Kolay temizlenebilir ve hijyeniktir.
- Paslanmaz çelik gövde.

DEVİRİLİR TAVALAR (ELEKTRİKLİ)

- Magnet emniyet ventilli termokulp ve termostat.
- Manuel kaldırma mekanizması.
- Karşı ağırlıklı kapak.
- Güvenlik sensörü.
- Kolay temizlenebilir ve hijyeniktir.
- Paslanmaz çelik gövde.

English

TILTING PANS (GAS)

- Lpg or Natural Gas.
- Safety gas valve thermocouple and thermostat.
- Manuel lift system.
- Counterweighted hinged lid.
- Safety switch.
- Easy to clean and hygienic.
- Stainless steel body.

TILTING PANS (ELECTRICAL)

- Safety valve thermocouple and thermostat.
- Manuel lift system.
- Counterweighted hinged lid.
- Safety switch.
- Easy to clean and hygienic.
- Stainless steel body.



Kaynatma Tencereleri (İndirekt)
Boiling Pans (Indirect)



Kod Code	Ürün Adı Description	Ebatlar Dimension mm			Ağırlık Weight kg	Net Net m ³	Güç Power kw	Kapasite Capacity lt	Fiyatı Price Euro
		a	b	c					
EMP.KTG.70	Kaynatma Tenceresi (Gazlı) Boiling Pan (Gas)	800x730x850			112	0.70	11.2	70	4.300
EMP.KTE.70	Kaynatma Tenceresi (Elektrikli) Boiling Pan (Electrical)	800x730x850			80	0.70	12	70	4.300

Kod Code	Elektrik Girişi Electric Input V	Kablo Kesiti Cable Cross Section mm ²
EMP.KTE.70	380	5x4

Kod Code	Gaz Tüketim Değeri Gas Consumption Ng	Gaz Tüketim Değeri Gas Consumption Lpg
EMP.KTG.70	1,18 m ³ /h	0,98 kg/h



Türkçe

KAYNATMA TENCERELERİ (GAZLI)

- Lpg ve Ng ile çalışabilme özelliği.
- Magnet emniyet ventilli termokulp ve termostat.
- Aşırı basınç valfi ve manometre.
- Soğuk, sıcak su doldurma musluğu.
- Tahliye musluğu.
- Karşı ağırlıklı kapak.
- Çift cidarlı çeket.
- Kolay temizlenebilir ve hijyeniktir.
- Paslanmaz çelik gövde.

KAYNATMA TENCERELERİ (ELEKTRİKLİ)

- Aşırı basınç valfi ve manometre.
- Soğuk, sıcak su doldurma musluğu.
- Tahliye musluğu.
- Karşı ağırlıklı kapak.
- Çift cidarlı çeket.
- Kolay temizlenebilir ve hijyeniktir.
- Paslanmaz çelik gövde.

English

BOILING PANS (GAS)

- Lpg or Natural Gas.
- Safety gas valve thermocouple and thermostat.
- Over pressure safety valve and manometer.
- Cold, hot water inlet valve.
- Drainage valve.
- Counterweighted hinged lid.
- Double jacket pan.
- Easy to clean and hygienic.
- Stainless steel body.

BOILING PANS (ELECTRICAL)

- Over pressure safety valve and manometer.
- Cold, hot water inlet valve.
- Drainage valve.
- Counterweighted hinged lid.
- Double jacket pan.
- Easy to clean and hygienic.
- Stainless steel body.



İş'in Mutfağı / Kitchen of Business

700 Serisi
700 Serie



empero@empero.com.tr



700+ Serisi 
700+ Serie



EMPERO

İş'in Mutfuğu / Kitchen of Business

empero@empero.com.tr



- * **Gazlı Ocaklar / Gas Cookers**
- * **Gazlı Wok Ocakları / Gas Wok Ranges**
- * **Elektrikli Ocaklar / Electric Cookers**
- * **Elektrikli Fritözler / Electric Fryers**
- * **Gazlı Fritözler / Gas Fryers**
- * **Elektrikli Makarna Haşlama - Patates Dinlendirme / Electric Pasta Cooker - Chips Scuttle**
- * **Gazlı Izgaralar / Gas Grills**
- * **Elektrikli Izgaralar / Electric Grills**
- * **Gazlı Sulu Izgara / Gas Vapor Grill**
- * **Gazlı Lavataşlı Izgaralar / Gas Lavastone Grills**
- * **Elektrikli Benmariler / Electric Bain maries**
- * **Ara Tezgahlar / Work Top with Cabinets**
- * **Set Altı / Worktop**
- * **Set Altı Fırınlr - Gazlı / Ovens - Gas**
- * **Set Altı Fırınlr - Elektrikli / Ovens - Electric**
- * **Devrilir Tavalr / Tilting Pans**
- * **Kaynatma Tencereleri (İndirekt) / Boiling Pans (Indirect)**
- * **Cantilever Hat / Cantilever Line**
- * **Paslanmaz Alt Bazalar / Stainless Steel Box Spring**

Gazlı Ocaklar
Gas Cookers



Kod Code	Ürün Adı Description	Ebatlar Dimension mm			Ağırlık Weight kg	Net Net m³	Güç Power kw	Fiyatı Price Euro
		a	b	c				
EMP.PLS.7KG010	2 Brülör'lü Gazlı Ocak 2 Burner Gas Cooker	400	730	300	40	0.09	11.5	845

Setüstü / Countertop

Kod Code	Gaz Tüketim Değeri Gas Consumption Ng	Gaz Tüketim Değeri Gas Consumption Lpg
EMP.PLS.7KG010	1,21 m³/h	0,90 kg/h



Kod Code	Ürün Adı Description	Ebatlar Dimension mm			Ağırlık Weight kg	Net Net m³	Güç Power kw	Fiyatı Price Euro
		a	b	c				
EMP.PLS.7KG020	4 Brülör'lü Gazlı Ocak 4 Burner Gas Cooker	800	730	300	70	0.18	23	1.550

Setüstü / Countertop

Kod Code	Gaz Tüketim Değeri Gas Consumption Ng	Gaz Tüketim Değeri Gas Consumption Lpg
EMP.PLS.7KG020	2,42 m³/h	1,80 kg/h



Kod Code	Ürün Adı Description	Ebatlar Dimension mm			Ağırlık Weight kg	Net Net m³	Güç Power kw	Fiyatı Price Euro
		a	b	c				
EMP.PLS.7KG030	6 Brülör'lü Gazlı Ocak 6 Burner Gas Cooker	1200	730	300	90	0.26	34.5	2.225

Setüstü / Countertop

Kod Code	Gaz Tüketim Değeri Gas Consumption Ng	Gaz Tüketim Değeri Gas Consumption Lpg
EMP.PLS.7KG030	3,63 m³/h	2,70 kg/h



2 mm üst tabla kalınlığı
2 mm top thickness

Türkçe

GAZLI OCAKLAR

- Lpg ve Ng ile çalışabilme özelliği.
- Magnet emniyet ventilli musluklar.
- Darbelere karşı dayanıklı üst döküm.
- Her brülör için piezzo çakmak ile kontrol.
- Kolay temizlenebilir ve hijyeniktir.
- Paslanmaz çelik gövde.

English

GAS COOKERS

- Lpg or Natural Gas.
- Magnet safety gas valve and thermocouple.
- Heavy duty top cast iron.
- Piezoelectric ignition system for each burner.
- Easy to clean and hygienic.
- Stainless steel body.



EMP.PLS.7KG030+EMP.PLS.7FRG03



EMP.PLS.7KG020+EMP.PLS.7FRG01



EMP.PLS.7KG010+EMP.PLS.7TS010

Gazlı Wok Ocakları
 Gas Wok Cookers

Kod Code	Ürün Adı Description	Ebatlar Dimension mm			Ağırlık Weight kg	Net Net m³	Güç Power kw	Fiyatı Price Euro
		a	b	c				
EMP.PLS.7WK010	1 Brülörlü Gazlı Wok Ocağı 1 Burner Gas Wok Cooker	400	730	300	37	0.09	18	850

Setüstü / Countertop

Kod Code	Gaz Tüketim Değeri Gas Consumption Ng	Gaz Tüketim Değeri Gas Consumption Lpg
EMP.PLS.7WK010	1,9 m³/h	1,05 kg/h



Kod Code	Ürün Adı Description	Ebatlar Dimension mm			Ağırlık Weight kg	Net Net m³	Güç Power kw	Fiyatı Price Euro
		a	b	c				
EMP.PLS.7WK020	2 Brülörlü Gazlı Wok Ocağı 2 Burner Gas Wok Cooker	800	730	300	72	0.18	36	1.450

Setüstü / Countertop

Kod Code	Gaz Tüketim Değeri Gas Consumption Ng	Gaz Tüketim Değeri Gas Consumption Lpg
EMP.PLS.7WK020	3,8 m³/h	2,1 kg/h

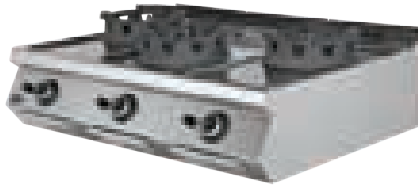

Kod Code	Ürün Adı Description	Ebatlar Dimension mm			Ağırlık Weight kg	Net Net m³	Güç Power kw	Fiyatı Price Euro
		a	b	c				
EMP.PLS.7WK030	3 Brülörlü Gazlı Wok Ocağı 3 Burner Gas Wok Cooker	1200	730	300	110	0.26	54	2.100

Setüstü / Countertop

Kod Code	Gaz Tüketim Değeri Gas Consumption Ng	Gaz Tüketim Değeri Gas Consumption Lpg
EMP.PLS.7WK030	5,6 m³/h	3,15 kg/h

Türkçe
GAZLI WOK OCAKLARI

- Lpg ve Ng ile çalışabilme özelliği.
- Magnet emniyet ventilli musluklar.
- Darbelere karşı dayanıklı üst döküm.
- Her brülör için piezzo çakmak ile kontrol.
- Kolay temizlenebilir ve hijyeniktir.
- Paslanmaz çelik gövde.

English
GAS WOK COOKERS

- Lpg or Natural Gas.
- Magnet safety gas valve and thermocouple.
- Heavy duty top cast iron.
- Piezoelectric ignition system for each burner.
- Easy to clean and hygienic.
- Stainless steel body.

2 mm üst tabla kalınlığı
2 mm top thickness

EMP.PLS.7WK010+EMP.PLS.7TS010

EMP.PLS.7WK020+EMP.PLS.7TS020

Elektrikli Ocaklar
Electric Cookers



Kod Code	Ürün Adı Description	Ebatlar Dimension mm			Ağırlık Weight kg	Net Net m ³	Güç Power kw	Fiyatı Price Euro
		a	b	c				
EMP.PLS.7KE010	2 Pleyt'li Elektrikli Ocak 2 Hot Plate Electric Cooker	400	730	300	37	0.09	4.5	740

Setüstü / Countertop

Kod Code	Elektrik Girişi Electric Input	Kablo Kesiti Cable Cross Section mm ²
EMP.PLS.7KE010	200 V. AC N PE	3 X 2,5



Kod Code	Ürün Adı Description	Ebatlar Dimension mm			Ağırlık Weight kg	Net Net m ³	Güç Power kw	Fiyatı Price Euro
		a	b	c				
EMP.PLS.7KE020	4 Pleyt'li Elektrikli Ocak 4 Hot Plate Electric Cooker	800	730	300	65	0.18	9	1.350

Setüstü / Countertop

Kod Code	Elektrik Girişi Electric Input	Kablo Kesiti Cable Cross Section mm ²
EMP.PLS.7KE020	400 V. AC 3N PE	5 X 2,5



Kod Code	Ürün Adı Description	Ebatlar Dimension mm			Ağırlık Weight kg	Net Net m ³	Güç Power kw	Fiyatı Price Euro
		a	b	c				
EMP.PLS.7KE030	6 Pleyt'li Elektrikli Ocak 6 Hot Plate Electric Cooker	1200	730	300	84	0.26	13.5	2.000

Setüstü / Countertop

Kod Code	Elektrik Girişi Electric Input	Kablo Kesiti Cable Cross Section mm ²
EMP.PLS.7KE030	400 V. AC 3N PE	5 X 4

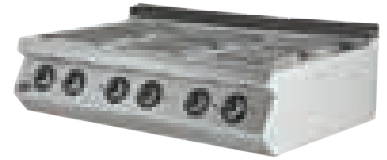

2 mm üst tabla kalınlığı
2 mm top thickness

Türkçe

ELEKTRİKLİ OCAKLARI

- 6 kademeli şalter.
- Kolay temizlenebilir ve hijyeniktir.
- Paslanmaz çelik gövde.

English

ELECTRIC COOKERS

- 6 position switches.
- Easy to clean and hygienic.
- Stainless steel body.



EMP.PLS.7KE030+EMP.PLS.7FRE020



EMP.PLS.7KE020+EMP.PLS.7TS020



EMP.PLS.7KE010+EMP.PLS.7TS010

Elektrikli Fritözler
 Electric Fryers

Kod Code	Ürün Adı Description	Ebatlar Dimension mm			Ağırlık Weight kg	Net Net m³	Güç Power kw	Kapasite Capacity lt	Fiyatı Price Euro
		a	b	c					
EMP.PLS.7FE010	Elektrikli Fritöz Electric Fryer	400	730	850	65	0.09	12	18	1.350

Dolaplı / With Cupboard

Kod Code	Elektrik Girişi Electric Input	Kablo Kesiti Cable Cross Section mm²
EMP.PLS.7FE010	400 V. AC 3N PE	5 X 4



Kod Code	Ürün Adı Description	Ebatlar Dimension mm			Ağırlık Weight kg	Net Net m³	Güç Power kw	Kapasite Capacity lt	Fiyatı Price Euro
		a	b	c					
EMP.PLS.7FE020	Elektrikli Fritöz Electric Fryer	800	730	850	110	0.18	24	2x18	2.300

Dolaplı / With Cupboard

Kod Code	Elektrik Girişi Electric Input	Kablo Kesiti Cable Cross Section mm²
EMP.PLS.7FE020	400 V. AC 3N PE	5 X 4

Türkçe
ELEKTRİKLİ FRİTÖZLER

- Termostatik kontrol.
- Paslanmaz çelik sepetler.
- Hareketli ısıtıcılar kolay temizlik imkanı sağlar.
- Tahliye musluğu ile emniyetli yağ boşaltma.
- Limit termostat.
- Kolay temizlenebilir ve hijyeniktir.
- Paslanmaz çelik gövde.

2 mm üst tabla kalınlığı
2 mm top thickness
English
ELECTRIC FRYERS

- Thermostatic control.
- Stainless steel baskets.
- Moving heaters provide easy cleaning.
- Safe oil drainage from the bottom via valve.
- Safety thermostat for overheating protection.
- Easy to clean and hygienic.
- Stainless steel body.



Gazlı Fritözler
Gas Fryers



Kod Code	Ürün Adı Description	Ebatlar Dimension mm			Ağırlık Weight kg	Net Net m³	Güç Power kw	Kapasite Capacity lt	Fiyatı Price Euro
		a	b	c					
EMP.PLS.7FG010	Gazlı Fritöz Gas Fryer	400	730	850	70	0.26	11.63	18	1.520

Dolaplı / With Cupboard

Kod Code	Gaz Tüketim Değeri Gas Consumption Ng	Gaz Tüketim Değeri Gas Consumption Lpg
EMP.PLS.7FG010	1,22 m³/h	0,61 kg/h

Kod Code	Ürün Adı Description	Ebatlar Dimension mm			Ağırlık Weight kg	Net Net m³	Güç Power kw	Kapasite Capacity lt	Fiyatı Price Euro
		a	b	c					
EMP.PLS.7FG020	Gazlı Fritöz Gas Fryer	800	730	850	130	0.52	23.25	2x18	2.530

Dolaplı / With Cupboard

Kod Code	Gaz Tüketim Değeri Gas Consumption Ng	Gaz Tüketim Değeri Gas Consumption Lpg
EMP.PLS.7FG020	2,45 m³/h	1,22 kg/h



2 mm üst tabla kalınlığı
2 mm top thickness



Türkçe

GAZLI FRİTÖZLER

- Lpg ve Ng ile çalışabilme özelliği.
- 220 V 50 Hz. çalışma voltajı.
- Termostatik kumanda.
- Paslanmaz çelik sepetler.
- Magnet emniyet ventilli musluklar.
- Boşaltma borusu ile emniyetli yağ boşaltma.
- Limit termostat.
- Kolay temizlenebilir ve hijyeniktir.
- Paslanmaz çelik gövde.

English

GAS FRYERS

- Lpg or Natural Gas.
- Operating voltage: 220 V 50 Hz.
- Thermostatic control.
- Stainless steel baskets.
- Magnet safety gas valve and thermocouple.
- Safe oil drainage from the bottom via valve.
- Safety thermostat for overheating protection.
- Easy to clean and hygienic.
- Stainless steel body.

Elektrikli Makarna Haşlama - Patates Dinlendirme
 Electric Pasta Cooker - Chips Scuttle

Kod Code	Ürün Adı Description	Ebatlar Dimension mm			Ağırlık Weight kg	Net Net m³	Güç Power kw	Kapasite Capacity lt	Fiyatı Price Euro
		a	b	c					
EMP.PLS.7ME010	Elektrikli Makarna Haşlama Electric Pasta Cooker	400	730	850	60	0.09	10.5	10.5	1.575

Dolaplı / With Cupboard

Kod Code	Elektrik Girişi Electric Input	Kablo Kesiti Cable Cross Section mm²
EMP.PLS.7ME010	400 V. AC 3N PE	5 X 4



Kod Code	Ürün Adı Description	Ebatlar Dimension mm			Ağırlık Weight kg	Net Net m³	Güç Power kw	Kapasite Capacity lt	Fiyatı Price Euro
		a	b	c					
EMP.PLS.7DE010	Patates Dinlendirme Chips Scuttle	400	730	300	39	0.09	GN 1/1X150 mm	535	

Setüstü / Countertop

Kod Code	Elektrik Girişi Electric Input	Kablo Kesiti Cable Cross Section mm²
EMP.PLS.7DE010	230 V. AC N PE	3 X 1,5

2 mm üst tabla kalınlığı
2 mm top thickness
Türkçe
ELEKTRİKLİ MAKARNA HAŞLAMA

- Termostatik kontrol.
- Paslanmaz çelik sepetler.
- Su doldurma musluğu.
- Tahliye musluğu ile su boşaltma.
- Taşan su tahliye sistemi.
- Kolay temizlenebilir ve hijyeniktir.
- Paslanmaz çelik gövde.

PATATES DİNLENDİRME

- Kızartılmış patateslerin sıcak bekletilmesinde ve yağların süzülmesinde kullanılır.
- Infrared seramik ısıtıcı.
- Havuzda kızartma yağının süzülmesi için maksimum verim sağlayan özel form.
- Kolay temizlenebilir ve hijyeniktir.
- Paslanmaz çelik gövde.

English
ELECTRIC PASTA COOKER

- Thermostatic control.
- Stainless steel baskets.
- Water filling tap.
- Discharge valve.
- Overflow drainage system.
- Easy to clean and hygienic.
- Stainless steel body.

CHIPS SCUTTLE

- Operates in order to keep fries warm and drain oil.
- Infrared ceramic heater.
- Special form on the container, provides maximum efficiency in order to drain oil.
- Easy to clean and hygienic.
- Stainless steel body.



EMP.PLS.7DE010+EMP.PLS.7TS010

Gazlı Izgaralar
Gas Grills



Kod Code	Ürün Adı Description	Ebatlar Dimension mm			Ağırlık Weight kg	Net Net m³	Güç Power kw	Fiyatı Price Euro
		a	b	c				
EMP.PLS.7IG010	Gazlı Izgara-Düz Gas Grill-Smooth	400	730	300	45	0.09	7.10	1.180



Setüstü / Countertop

Kod Code	Gaz Tüketim Değeri Gas Consumption Ng	Gaz Tüketim Değeri Gas Consumption Lpg
EMP.PLS.7IG010	0,75 m³/h	0,52 kg/h

Kod Code	Ürün Adı Description	Ebatlar Dimension mm			Ağırlık Weight kg	Net Net m³	Güç Power kw	Fiyatı Price Euro
		a	b	c				
EMP.PLS.7IG020	Gazlı Izgara-Düz Gas Grill-Smooth	800	730	300	90	0.18	14.20	1.890
EMP.PLS.7IG022	Gazlı Izgara-Düz+Oluklu Gas Grill- Smooth+Ribbed	800	730	300	92	0.18	14.20	2.000



Setüstü / Countertop

Kod Code	Gaz Tüketim Değeri Gas Consumption Ng	Gaz Tüketim Değeri Gas Consumption Lpg
EMP.PLS.7IG020	1,50 m³/h	1,04 kg/h
EMP.PLS.7IG022	1,50 m³/h	1,04 kg/h



Kod Code	Ürün Adı Description	Ebatlar Dimension mm			Ağırlık Weight kg	Net Net m³	Güç Power kw	Fiyatı Price Euro
		a	b	c				
EMP.PLS.7IG030	Gazlı Izgara-Düz Gas Grill-Smooth	1200	730	300	125	0.24	21.3	2.500
EMP.PLS.7IG032	Gazlı Izgara-Düz+Oluklu Gas Grill- Smooth+Ribbed	1200	730	300	127	0.24	21.3	2.700



Setüstü / Countertop

Kod Code	Gaz Tüketim Değeri Gas Consumption Ng	Gaz Tüketim Değeri Gas Consumption Lpg
EMP.PLS.7IG030	2,15 m³/h	1,56 kg/h
EMP.PLS.7IG032	2,15 m³/h	1,56 kg/h

2 mm üst tabla kalınlığı
2 mm top thickness

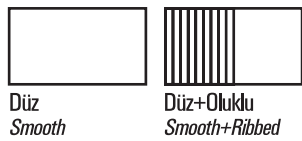

Türkçe

GAZLI IZGARALAR

- Lpg ve Ng ile çalışabilme özelliği.
- Magnet emniyet ventilli ve pilotlu musluklar.
- Tam modüllerde iki bölgeyi ısıtma.
- Her brülör için piezo çakmak ile kontrol.
- Çıkarılabilir yağ toplama haznesi.
- Kolay temizlenebilir ve hijyeniktir.
- Paslanmaz çelik gövde.

Krom Tablalı
Chrome Plate

English

GAS GRILLS

- Lpg or Natural Gas.
- Magnet safety gas valve and pilot flame.
- Two separate heating zones.
- Piezoelectric ignition system for each burner.
- Removable oil collection drawer.
- Easy to clean and hygienic.
- Stainless steel body.

Elektrikli Izgaralar
 Electric Grills

Kod Code	Ürün Adı Description	Ebatlar Dimension mm			Ağırlık Weight kg	Net Net m ³	Güç Power kw	Fiyatı Price Euro
		a	b	c				
EMP.PLS.71E010	Elektrikli Izgara-Düz Electric Grill-Smooth	400	730	300	47	0.09	4.2	1.180

Setüstü / Countertop

Kod Code	Elektrik Girişi Electric Input	Kablo Kesiti Cable Cross Section mm ²
EMP.PLS.71E010	400 V. AC 3N PE	5 X 2,5



Kod Code	Ürün Adı Description	Ebatlar Dimension mm			Ağırlık Weight kg	Net Net m ³	Güç Power kw	Fiyatı Price Euro
		a	b	c				
EMP.PLS.71E020	Elektrikli Izgara-Düz Electric Grill-Smooth	800	730	300	92	0.18	8.4	2.000
EMP.PLS.71E022	Elektrikli Izgara-Düz+Oluklu Electric Grill-Smooth+Ribbed	800	730	300	95	0.18	8.4	2.120

Setüstü / Countertop



Kod Code	Elektrik Girişi Electric Input	Kablo Kesiti Cable Cross Section mm ²
EMP.PLS.71E020	400 V. AC 3N PE	5 X 2,5
EMP.PLS.71E022	400 V. AC 3N PE	5 X 2,5

NEW

Kod Code	Ürün Adı Description	Ebatlar Dimension mm			Ağırlık Weight kg	Net Net m ³	Güç Power kw	Fiyatı Price Euro
		a	b	c				
EMP.PLS.71E030	Elektrikli Izgara-Düz Electric Grill-Smooth	1200	730	300	125	0.24	10.8	2.800
EMP.PLS.71E032	Elektrikli Izgara-Düz+Oluklu Electric Grill-Smooth+Ribbed	1200	730	300	127	0.24	10.8	3.100

Setüstü / Countertop

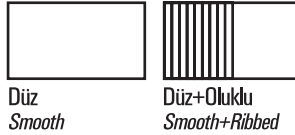

Kod Code	Elektrik Girişi Electric Input	Kablo Kesiti Cable Cross Section mm ²
EMP.PLS.71E030	400 V. AC 3N PE	5 X 2,5
EMP.PLS.71E032	400 V. AC 3N PE	5 X 2,5

2 mm üst tabla kalınlığı
2 mm top thickness
Krom Tablalı
Chrome Plate
Türkçe
ELEKTRİKLİ IZGARALAR

- Termostatik kumanda.
- Tam modüllerde iki bölgeyi ısıtma.
- Çıkarılabilir yağ toplama haznesi
- Kolay temizlenebilir ve hijyeniktir.
- Paslanmaz çelik gövde.

English
ELECTRIC GRILLS

- Thermostatic control.
- Two separate heating zones.
- Removable oil collection drawer.
- Easy to clean and hygienic.
- Stainless steel body.

Gazlı Sulu Izgara
Gas Vapor Grill



Kod Code	Ürün Adı Description	Ebatlar Dimension mm			Ağırlık Weight kg	Net Net m ³	Güç Power kw	Fiyatı Price Euro
		a	b	c				
EMP.PLS.7LG010-S	Gazlı Sulu Izgara Gas Vapor Grill	400	730	300	45	0.09	5.20	845



Setüstü / Countertop

Kod Code	Gaz Tüketim Değeri Gas Consumption Ng	Gaz Tüketim Değeri Gas Consumption Lpg
EMP.PLS.7LG010-S	0,55 m ³ /h	0,60 kg/h

Kod Code	Ürün Adı Description	Ebatlar Dimension mm			Ağırlık Weight kg	Net Net m ³	Güç Power kw	Fiyatı Price Euro
		a	b	c				
EMP.PLS.7LG020-S	Gazlı Sulu Izgara Gas Vapor Grill	800	730	300	90	0.18	10.40	1.400



Setüstü / Countertop

Kod Code	Gaz Tüketim Değeri Gas Consumption Ng	Gaz Tüketim Değeri Gas Consumption Lpg
EMP.PLS.7LG020-S	1,10 m ³ /h	1,20 kg/h

Kod Code	Ürün Adı Description	Ebatlar Dimension mm			Ağırlık Weight kg	Net Net m ³	Güç Power kw	Fiyatı Price Euro
		a	b	c				
EMP.PLS.7LG030-S	Gazlı Sulu Izgara Gas Vapor Grill	1200	730	300	135	0.26	15.60	1.900



Setüstü / Countertop

Kod Code	Gaz Tüketim Değeri Gas Consumption Ng	Gaz Tüketim Değeri Gas Consumption Lpg
EMP.PLS.7LG030-S	1,65 m ³ /h	1,80 kg/h



EMP.PLS.7LG030-S+EMP.PLS.7TS030

2 mm üst tabla kalınlığı
2 mm top thickness

Türkçe

GAZLI SULU IZGARA

- Buharlaştırma kabini sayesinde daha verimli pişirme.
- Lpg ve Ng ile çalışabilme özelliği.
- Magnet emniyet ventilli ve pilotlu musluklar.
- Tam modüllerde iki bölgeyi ısıtma.
- Her brülör için piezo çakmak ile kontrol.
- Pik döküm ızgara.
- Kolay temizlenebilir ve hijyeniktir.
- Paslanmaz çelik gövde.

English

GAS VAPOR GRILL

- Steamer cabinet provides fertile cooking.
- Lpg or Natural Gas.
- Magnet safety gas valve and pilot flame .
- Two separate heating zones .
- Piezoelectric ignition system for each burner.
- Cast iron plate.
- Easy to clean and hygienic.
- Stainless steel body.

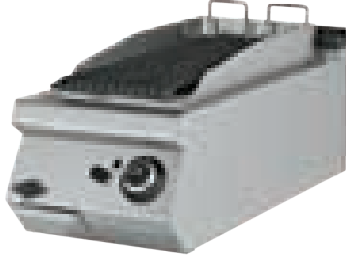
Gazlı Lavataşlı Izgaralar
 Gas Lavastone Grills

Kod Code	Ürün Adı Description	Ebatlar Dimension mm			Ağırlık Weight kg	Net Net m³	Güç Power kw	Fiyatı Price Euro
		a	b	c				
EMP.PLS.7LG010	Lavataşlı Izgara - Gazlı Lavastone Grills - Gas	400	730	300	68	0.09	8.60	750

Setüstü / Countertop

Kod Code	Gaz Tüketim Değeri Gas Consumption Ng	Gaz Tüketim Değeri Gas Consumption Lpg
EMP.PLS.7LG010	0,91 m³/h	0,77 kg/h



Kod Code	Ürün Adı Description	Ebatlar Dimension mm			Ağırlık Weight kg	Net Net m³	Güç Power kw	Fiyatı Price Euro
		a	b	c				
EMP.PLS.7LG020	Lavataşlı Izgara - Gazlı Lavastone Grills - Gas	800	730	300	107	0.18	17.20	1.235

Setüstü / Countertop

Kod Code	Gaz Tüketim Değeri Gas Consumption Ng	Gaz Tüketim Değeri Gas Consumption Lpg
EMP.PLS.7LG020	1,82 m³/h	0,86 kg/h



Kod Code	Ürün Adı Description	Ebatlar Dimension mm			Ağırlık Weight kg	Net Net m³	Güç Power kw	Fiyatı Price Euro
		a	b	c				
EMP.PLS.7LG030	Lavataşlı Izgara - Gazlı Lavastone Grills - Gas	1200	730	300	175	0.24	25.80	1.750

Setüstü / Countertop

Kod Code	Gaz Tüketim Değeri Gas Consumption Ng	Gaz Tüketim Değeri Gas Consumption Lpg
EMP.PLS.7LG030	2,73 m³/h	1,29 kg/h

Döküm üst ızgara
Cast iron top
Türkçe
GAZLI LAVATAŞLI IZGARALAR

- Lpg ve Ng ile çalışabilme özelliği.
- Magnet emniyet ventilli ve pilotlu musluklar.
- Tam modüllerde iki bölgeyi ısıtma.
- Her brülör için piezo çakmak ile kontrol.
- Çıkarılabilir yağ toplama haznesi.
- Kolay temizlenebilir ve hijyeniktir.
- Paslanmaz çelik gövde.

English
GAS LAVASTONE GRILLS

- Lpg or Natural Gas.
- Safety gas valve and pilot flame.
- Two separate heating zones.
- Piezoelectric ignition system for each burner.
- Removable oil collection drawer.
- Easy to clean and hygienic.
- Stainless steel body.

2 mm üst tabla kalınlığı
2 mm top thickness

Elektrikli Benmariler
Electric Bain maries



Kod Code	Ürün Adı Description	Ebatlar Dimension mm			Ağırlık Weight kg	Net Net m³	Güç Power kw	Fiyatı Price Euro
		a	b	c				
EMP.PLS.7SE010	Elektrikli Benmari Electric Bain marie	400	730	850	65	0.09	1.5	925

Dolaplı / With Cupboard

Kod Code	Elektrik Girişi Electric Input	Kablo Kesiti Cable Cross Section mm²
EMP.PLS.7SE010	230 V. AC N PE	3 X 1,5

Kod Code	Ürün Adı Description	Ebatlar Dimension mm			Ağırlık Weight kg	Net Net m³	Güç Power kw	Fiyatı Price Euro
		a	b	c				
EMP.PLS.7SE020	Elektrikli Benmari Electric Bain marie	800	730	850	115	0.18	3	1.515

Dolaplı / With Cupboard

Kod Code	Elektrik Girişi Electric Input	Kablo Kesiti Cable Cross Section mm²
EMP.PLS.7SE020	230 V. AC N PE	3 X 2,5

2 mm üst tabla kalınlığı
2 mm top thickness



Türkçe

ELEKTRİKLİ BENMARİLER

- Termostatik kumanda.
- Yarım modül de 1 adet GN1/1.
- Tam modül de ise 2 adet GN1/1.
- Tahliye musluğu.
- Su alma musluğu.
- Kolay temizlenebilir ve hijyeniktir.
- Paslanmaz çelik gövde.

*Standart üretimimizde küvet bulunmamaktadır.

English

ELECTRIC BAIN MARIES

- Thermostatic control.
- Capacity of half modul ; 1 piece of GN1/1.
- Capacity of full modul ; 2 pieces of GN1/1.
- Drainage valve.
- Water inlet valve.
- Easy to clean and hygienic.
- Stainless steel body.

*Standart product does not have containers.

Ara Tezgahlar
Undercounter Cabinet



Kod Code	Ürün Adı Description	Ebatlar Dimension mm			Ağırlık Weight kg	Net Net m³	Fiyatı Price Euro
		a	b	c			
EMP.PLS.7TN010	Ara Tezgah 1/2 Mod Worktop 1/2 Module	400	730	300	17	0.09	325

Setüstü / Countertop

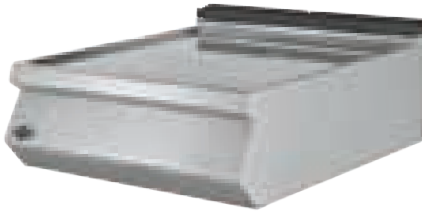

Kod Code	Ürün Adı Description	Ebatlar Dimension mm			Ağırlık Weight kg	Net Net m³	Fiyatı Price Euro
		a	b	c			
EMP.PLS.7TN020	Ara Tezgah / 1 Mod Worktop 1 Module	800	730	300	30	0.18	550

Setüstü / Countertop

2 mm üst tabla kalınlığı
2 mm top thickness

Türkçe

ARA TEZGAHLAR

- Tezgahlar 60 seri cihazların altına kullanılabilecek uygun modüler ölçülerdedir.
- Kolay temizlenebilir ve hijyeniktir.
- Paslanmaz çelik gövde.

English

UNDERCOUNTER CABINET

- Under-Set Counters are suitable to use under each kind of 60's serie equipments.
- Easy to clean and hygienic.
- Stainless steel body.



EMP.PLS.7TN020+EMP.PLS.7TS020



EMP.PLS.7TN010+EMP.PLS.7TS010

Set Altı
Worktop



Kod Code	Ürün Adı Description	Ebatlar Dimension mm			Ağırlık Weight kg	Net Net m ³	Fiyatı Price Euro
		a	b	c			
EMP.PLS.7TS010	Set Altı Tezgah Undercounter Cabinet	400x620x550			21	0.09	340



Kod Code	Ürün Adı Description	Ebatlar Dimension mm			Ağırlık Weight kg	Net Net m ³	Fiyatı Price Euro
		a	b	c			
EMP.PLS.7TS020	Set Altı Tezgah Undercounter Cabinet	800x620x550			30	0.18	510



Kod Code	Ürün Adı Description	Ebatlar Dimension mm			Ağırlık Weight kg	Net Net m ³	Fiyatı Price Euro
		a	b	c			
EMP.PLS.7TS030	Set Altı Tezgah Undercounter Cabinet	1200x620x550			38	0.26	785



Set Altı Fırınlar - Gazlı
 Ovens - Gas

Kod Code	Ürün Adı Description	Ebatlar Dimension mm			Ağırlık Weight kg	Net Net m ³	Güç Power kw	Fiyatı Price Euro
		a	b	c				
EMP.PLS.7FRG01	Set Altı Fırınlar - Gazlı Ovens - Gas	800	620	550	60	0.27	6.46	1.040



Kod Code	Ürün Adı Description	Ebatlar Dimension mm			Ağırlık Weight kg	Net Net m ³	Güç Power kw	Fiyatı Price Euro
		a	b	c				
EMP.PLS.7FRG02	Set Altı Fırınlar - Gazlı Ovens - Gas	1200	620	550	80	0.41	6.46	1.270



Kod Code	Ürün Adı Description	Ebatlar Dimension mm			Ağırlık Weight kg	Net Net m ³	Güç Power kw	Fiyatı Price Euro
		a	b	c				
EMP.PLS.7FRG03	Set Altı Maxi Fırınlar - Gazlı Maxi Ovens - Gas	1200	620	550	90	0.41	12.93	1.545

Türkçe
SET ALTI FIRINLAR - GAZLI

- Lpg ve Ng ile çalışabilme özelliği.
- 2xGN 2/1 tepsi kapasiteli paslanmaz çelik fırın iç haznesi.
- Termostatik ayarlı fırın gaz ventili.

English
OVENS - GAS

- Lpg or Natural Gas
- 2xGN 2/1 capacity, stainless steel internal chamber.
- For oven: temperature control with thermostatic gas valve.

Set Altı Fırınlar - Elektrikli
Ovens - Electric



Kod Code	Ürün Adı Description	Ebatlar Dimension mm			Ağırlık Weight kg	Net Net m ³	Güç Power kw	Fiyatı Price Euro
		a	b	c				
EMP.PLS.7FRE01	Set Altı Fırınlar - Elektrikli Ovens - Electric	800	620	550	60	0.27	9	905



Kod Code	Ürün Adı Description	Ebatlar Dimension mm			Ağırlık Weight kg	Net Net m ³	Güç Power kw	Fiyatı Price Euro
		a	b	c				
EMP.PLS.7FRE02	Set Altı Fırınlar - Elektrikli Ovens - Electric	1200	620	550	80	0.41	9	1.050



Kod Code	Ürün Adı Description	Ebatlar Dimension mm			Ağırlık Weight kg	Net Net m ³	Güç Power kw	Fiyatı Price Euro
		a	b	c				
EMP.PLS.7FRE03	Set Altı Maxi Fırınlar - Elektrikli Maxi Ovens - Electric	1200	620	550	90	0.41	15	1.360



Türkçe

SET ALTI FIRINLAR - ELEKTRİKLİ

- 2xGN 2/1 tepsi kapasiteli paslanmaz çelik fırın iç haznesi.

English

OVENS - ELECTRIC

- 2xGN 2/1 capacity, stainless steel internal chamber.

Devrilir Tavalar
Tilting Pans



Kod Code	Ürün Adı Description	Ebatlar Dimension mm			Ağırlık Weight kg	Net Net m ³	Güç Power kw	Kapasite Capacity lt	Fiyatı Price Euro
		a	b	c					
EMP.PLS.DTG.50	Devrilir Tava (Gazlı) Tilting Pan (Gas)	800x730x850			125	0.70	11.20	50	2.785
EMP.PLS.DTE.50	Devrilir Tava (Elektrikli) Tilting Pan (Electrical)	800x730x850			138	0.70	9	50	2.785

Kod Code	Elektrik Girişi Electric Input V	Kablo Kesiti Cable Cross Section mm ²
EMP.PLS.DTE.50	380	5x4

Kod Code	Gaz Tüketim Değeri Gas Consumption Ng	Gaz Tüketim Değeri Gas Consumption Lpg
EMP.PLS.DTG.50	1,18 m ³ /h	0,68 kg/h

Türkçe

DEVİRLİR TAVALAR (GAZLI)

- Lpg ve Ng ile çalışabilme özelliği.
- Magnet emniyet ventilli termokulp ve termostat.
- Manuel kaldırma mekanizması.
- Karşı ağırlıklı kapak.
- Güvenlik sensörü.
- Kolay temizlenebilir ve hijyeniktir.
- Paslanmaz çelik gövde.

DEVİRLİR TAVALAR (ELEKTRİKLİ)

- Magnet emniyet ventilli termokulp ve termostat.
- Manuel kaldırma mekanizması.
- Karşı ağırlıklı kapak.
- Güvenlik sensörü.
- Kolay temizlenebilir ve hijyeniktir.
- Paslanmaz çelik gövde.

English

TILTING PANS (GAS)

- Lpg or Natural Gas.
- Safety gas valve thermocouple and thermostat.
- Manuel lift system.
- Counterweighted hinged lid.
- Safety switch.
- Easy to clean and hygienic.
- Stainless steel body.

TILTING PANS (ELECTRICAL)

- Safety valve thermocouple and thermostat.
- Manuel lift system.
- Counterweighted hinged lid.
- Safety switch.
- Easy to clean and hygienic.
- Stainless steel body.

Kaynatma Tencereleri (İndirekt)
Boiling Pans (Indirect)



Kod Code	Ürün Adı Description	Ebatlar Dimension mm			Ağırlık Weight kg	Net Net m ³	Güç Power kw	Kapasite Capacity lt	Fiyatı Price Euro
		a	b	c					
EMP.PLS.KTG.70	Kaynatma Tenceresi (Gazlı) Boiling Pan (Gas)	800x730x850			112	0.70	11.20	70	4.635
EMP.PLS.KTE.70	Kaynatma Tenceresi (Elektrikli) Boiling Pan (Electrical)	800x730x850			80	0.70	12	70	4.635

Kod Code	Elektrik Girişi Electric Input V	Kablo Kesiti Cable Cross Section mm ²
EMP.PLS.KTE.70	380	5x4

Kod Code	Gaz Tüketim Değeri Gas Consumption Ng	Gaz Tüketim Değeri Gas Consumption Lpg
EMP.PLS.KTG.70	1,18 m ³ /h	0,98 kg/h



Türkçe

KAYNATMA TENCERELERİ (GAZLI)

- Lpg ve Ng ile çalışabilme özelliği.
- Magnet emniyet ventilli termokulp ve termostat.
- Aşırı basınç valfi ve manometre.
- Soğuk, sıcak su doldurma musluğu.
- Tahliye musluğu.
- Karşı ağırlıklı kapak.
- Çift cidarlı ceket.
- Kolay temizlenebilir ve hijyeniktir.
- Paslanmaz çelik gövde.

KAYNATMA TENCERELERİ (ELEKTRİKLİ)

- Aşırı basınç valfi ve manometre.
- Soğuk, sıcak su doldurma musluğu.
- Tahliye musluğu.
- Karşı ağırlıklı kapak.
- Çift cidarlı ceket.
- Kolay temizlenebilir ve hijyeniktir.
- Paslanmaz çelik gövde.

English

BOILING PANS (GAS)

- Lpg or Natural Gas.
- Safety gas valve thermocouple and thermostat.
- Over pressure safety valve and manometer.
- Cold, hot water inlet valve.
- Drainage valve.
- Counterweighted hinged lid.
- Double jacket pan.
- Easy to clean and hygienic.
- Stainless steel body.

BOILING PANS (ELECTRICAL)

- Over pressure safety valve and manometer.
- Cold, hot water inlet valve.
- Drainage valve.
- Counterweighted hinged lid.
- Double jacket pan.
- Easy to clean and hygienic.
- Stainless steel body.

Cantilever Hat
Cantilever Line

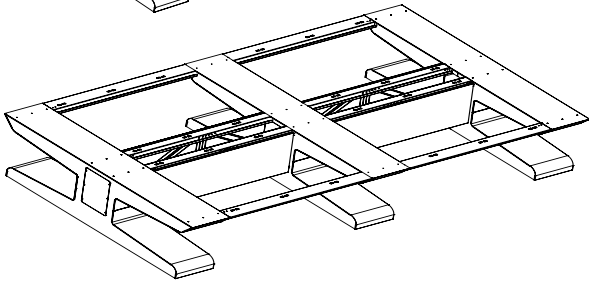
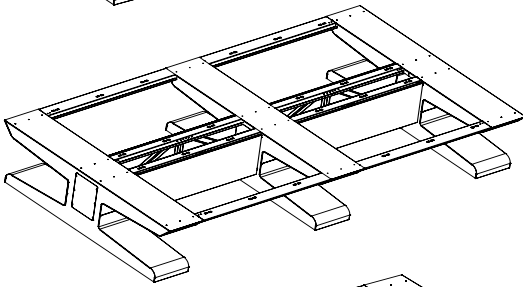
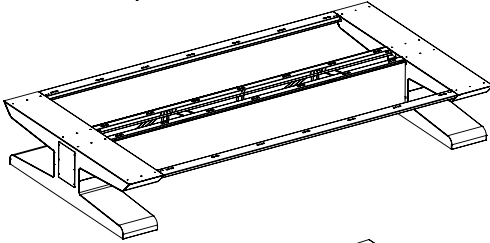
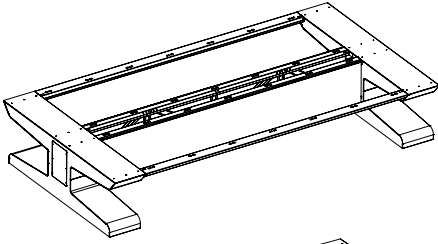
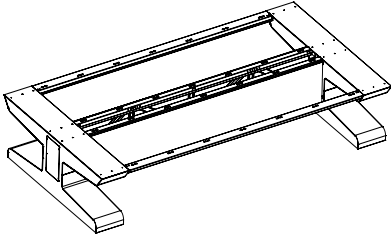

Kod Code	Ürün Adı Description	Ebatlar Dimension mm			Fiyatı Price Euro
		a	b	c	
EMP.PLS.7CTV240	Cantilever Hat Cantilever Line	2400	1370	550	3.640

Kod Code	Ürün Adı Description	Ebatlar Dimension mm			Fiyatı Price Euro
		a	b	c	
EMP.PLS.7CTV280	Cantilever Hat Cantilever Line	2800	1370	550	4.440

Kod Code	Ürün Adı Description	Ebatlar Dimension mm			Fiyatı Price Euro
		a	b	c	
EMP.PLS.7CTV320	Cantilever Hat Cantilever Line	3200	1370	550	4.860

Kod Code	Ürün Adı Description	Ebatlar Dimension mm			Fiyatı Price Euro
		a	b	c	
EMP.PLS.7CTV360	Cantilever Hat Cantilever Line	3600	1370	550	5.670

Kod Code	Ürün Adı Description	Ebatlar Dimension mm			Fiyatı Price Euro
		a	b	c	
EMP.PLS.7CTV400	Cantilever Hat Cantilever Line	4000	1370	550	6.065

Gazlı fritözler, Elektrikli fritözler, Elektrikli Benmariler, Elektrikli Makarna Haşlamalar ürünlerinde ALT KISIM dolaplı olarak gelmektedir.

For Gas Fryers , Electrical Fryers , Electrical Bainmaries and Electrical Pasta Cookers BOTTOM SIDE includes Cabinet.

Paslanmaz Alt Bazalar
Stainless Steel Box Spring



Tablo/Table

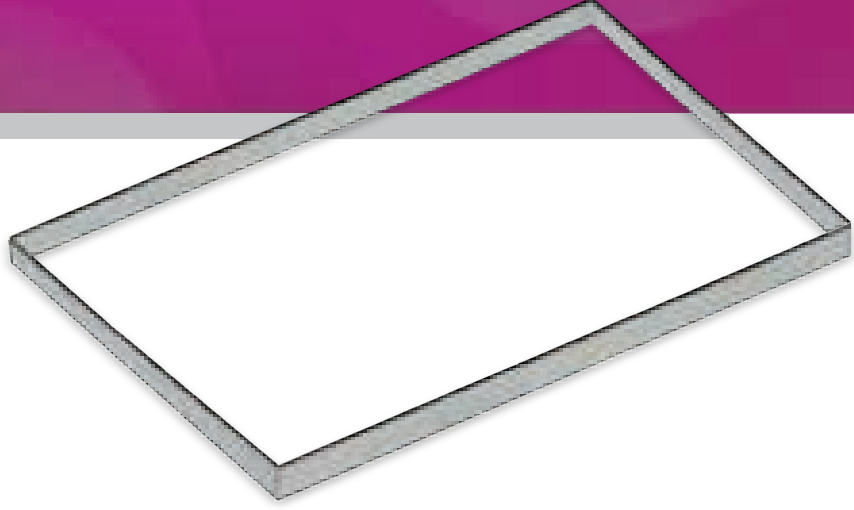

Kod Code	Ürün Adı Description	Fiyatı Price Euro
EMP.PLS.7SBP240	Paslanmaz Alt Bazalar - 240 cm Stainless Steel Box Spring - 240 cm	560

Kod Code	Ürün Adı Description	Fiyatı Price Euro
EMP.PLS.7SBP280	Paslanmaz Alt Bazalar - 280 cm Stainless Steel Box Spring - 280 cm	675

Kod Code	Ürün Adı Description	Fiyatı Price Euro
EMP.PLS.7SBP320	Paslanmaz Alt Bazalar - 320 cm Stainless Steel Box Spring - 320 cm	790

Kod Code	Ürün Adı Description	Fiyatı Price Euro
EMP.PLS.7SBP360	Paslanmaz Alt Bazalar - 360 cm Stainless Steel Box Spring - 360 cm	900

Kod Code	Ürün Adı Description	Fiyatı Price Euro
EMP.PLS.7SBP400	Paslanmaz Alt Bazalar - 400 cm Stainless Steel Box Spring - 400 cm	1.010



İş'in Mutfakı / Kitchen of Business

700 Plus Serisi
700 Plus Serie



empero@empero.com.tr



900 Serisi

900 Serie



14'ın Mutfağı / Kitchen of Business

empero@empero.com.tr



- * **Gazlı Kuzineler - Fırınlı / Gas Ranges with Oven**
- * **Yer Ocakları / Single Ranges**
- * **Yer Ocakları 4 Yanırlı / Single Ranges- 4 Ring**
- * **Gazlı Ocaklar / Gas Cookers**
- * **Gazlı Ocaklar / Gas Cookers**
- * **Gazlı Wok Ocakları / Gas Wok Ranges**
- * **Elektrikli Ocaklar / Electric Cookers**
- * **Elektrikli Fritözler / Electric Fryers**
- * **Gazlı Fritözler / Gas Fryers**
- * **Elektrikli Makarna Haşlama - Patates Dinlendirme / Electric Pasta Cooker - Chips Scuttle**
- * **Gazlı Izgaralar / Gas Grills**
- * **Elektrikli Izgaralar / Electric Grills**
- * **Gazlı Lavataşlı Izgaralar / Gas Lavastone Grills**
- * **Gazlı Sulu Izgara / Gas Vapor Grill**
- * **Elektrikli Benmariler / Electric Bain maries**
- * **Ara Tezgahlar / Work Top with Cabinets**
- * **Set Altı Tezgah - Kapaklı / Undercounter Cabinet - With Door**
- * **Set Altı Tezgah - Kapaksız / Undercounter Cabinet - Without Door**
- * **Set Altı Fırınlar - Gazlı / Ovens - Gas**
- * **Set Altı Fırınlar - Elektrikli / Ovens - Electric**
- * **Kaynatma Tencereleri (İndirekt) / Boiling Pans (Indirect)**
- * **Devrilir Tavalar / Tilting Pans**

900 Serisi
900 Serie



Gazlı Kuzineler - Fırınlı Gas Ranges with Oven



Kod Code	Ürün Adı Description	Ebatlar Dimension mm			Ağırlık Weight kg	Net Net m ³	Güç Power kw	Fiyatı Price Euro
		a	b	c				
EMP.9KG.021	4 Brülör'lü Fırınlı Gazlı Kuzine-Ventilli 4 Burner Gas Range-With Oven, Valve	1000	1000	850	155	0.85	40	1.650

Kod Code	Gaz Tüketim Değeri Gas Consumption Ng	Gaz Tüketim Değeri Gas Consumption Lpg
EMP.9KG.021	4,16 m ³ /h	3,13 kg/h

Kontrol Paneli Control Panel



Türkçe

GAZLI KUZINELER - FIRINLI

- Lpg ve Ng ile çalışabilme özelliği.
- 2xGN 2/1 tepsi kapasiteli paslanmaz çelik fırın haznesi.
- Magnet emniyet ventilli musluklar.
- Darbelere karşı dayanıklı üst döküm.
- Kolay temizlenebilir ve hijyeniktir.
- Paslanmaz çelik gövde.

English

GAS RANGES WITH OVEN

- Lpg or Natural Gas.
- 2xGN 2/1 capacity, stainless steel internal chamber.
- Magnet safety valves.
- Heavy duty top cast iron.
- Easy to clean and hygienic.
- Stainless steel body.

Yer Ocakları
 Single Ranges

Kod Code	Ürün Adı Description	Ebatlar Dimension mm			Ağırlık Weight kg	Net Net m³	Güç Power kw	Fiyatı Price Euro
		a	b	c				
EMP.YRG.60	Yer Ocağı-Ventilli Gas Stock Pot Stove-With Valve	600	800	500	60	0.24	27.24	525

Kod Code	Gaz Tüketim Değeri Gas Consumption Ng	Gaz Tüketim Değeri Gas Consumption Lpg
EMP.YRG.60	2,88 m³/h	1,42 kg/h



Kod Code	Ürün Adı Description	Ebatlar Dimension mm			Ağırlık Weight kg	Net Net m³	Güç Power kw	Fiyatı Price Euro
		a	b	c				
EMP.YRE.60	Elektrikli Yer Ocağı Electric Stock Pot Stove	600	800	500	60	0.24	4	530

Kod Code	Elektrik Girişi Electric Input V	Kablo Kesiti Cable Cross Section mm²
EMP.YRE.60	220-380	3x2.5

Türkçe
YER OCAKLARI

- Lpg ve Ng ile çalışabilme özelliği.
- Magnet emniyet ventilli musluklar.
- Darbelere karşı dayanıklı üst döküm.
- Kolay temizlenebilir ve hijyeniktir.
- Paslanmaz çelik gövde.

English
SINGLE RANGES

- Lpg or Natural Gas.
- Magnet safety valves.
- Heavy duty top cast iron.
- Easy to clean and hygienic.
- Stainless steel body.

900 Serisi
900 Serie



Yer Ocakları - 4 Yanışlı Single Ranges - 4 Ring



Kod Code	Ürün Adı Description	Ebatlar Dimension mm			Ağırlık Weight kg	Net Net m³	Güç Power kw	Fiyatı Price Euro
		a	b	c				
EMP.YRG.80	Yer Ocağı 4 Yanışlı-Ventilli 4 Ring Stock Pot Stove-With Valve	700	915	560	80	0.35	31.25	825

Kod Code	Gaz Tüketim Değeri Gas Consumption Ng	Gaz Tüketim Değeri Gas Consumption Lpg
EMP.YRG.80	3,30 m³/h	2,48 kg/h

900 Serisi
900 Serie



**4 YANIŞLI BRULÖR
4 RING HIGH POWER BURNER**

Türkçe

YER OCAKLARI 4 YANIŞLI

- Lpg ve Ng ile çalışabilme özelliği.
- Magnet emniyet ventilli musluklar.
- Darbelere karşı dayanıklı üst döküm.
- Kolay temizlenebilir ve hijyeniktir.
- Paslanmaz çelik gövde.

English

SINGLE RANGES - 4 RING

- Lpg or Natural Gas.
- Magnet safety valves.
- Heavy duty top cast iron.
- Easy to clean and hygienic.
- Stainless steel body.

Gazlı Ocaklar
 Gas Cookers

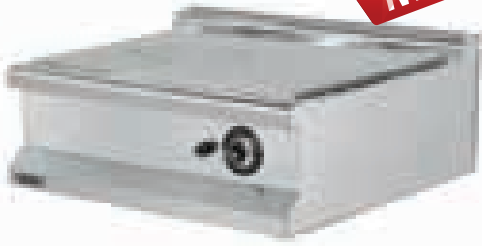
NEW

Kod Code	Ürün Adı Description	Ebatlar Dimension mm			Ağırlık Weight kg	Net Net m³	Güç Power kw	Fiyatı Price Euro
		a	b	c				
EMP.9KG020-O	Kapalı Döküm Gazlı Ocak Solid Top Gas Cooker	800	900	285	60	0.21	14	1.400

Setüstü / Countertop

Kod Code	Gaz Tüketim Değeri Gas Consumption Ng	Gaz Tüketim Değeri Gas Consumption Lpg
EMP.9KG020-O	1,4 m³/h	1,1 kg/h



Kod Code	Ürün Adı Description	Ebatlar Dimension mm			Ağırlık Weight kg	Net Net m³	Güç Power kw	Fiyatı Price Euro
		a	b	c				
EMP.9KG010	2 Brülör'lü Gazlı Ocak 2 Burner Gas Cooker	400	900	285	35	0.10	11.50	810

Setüstü / Countertop

Kod Code	Gaz Tüketim Değeri Gas Consumption Ng	Gaz Tüketim Değeri Gas Consumption Lpg
EMP.9KG010	1,21 m³/h	0,90 kg/h



Kod Code	Ürün Adı Description	Ebatlar Dimension mm			Ağırlık Weight kg	Net Net m³	Güç Power kw	Fiyatı Price Euro
		a	b	c				
EMP.9KG020	4 Brülör'lü Gazlı Ocak 4 Burner Gas Cooker	800	900	285	65	0.21	23	1.490

Setüstü / Countertop

Kod Code	Gaz Tüketim Değeri Gas Consumption Ng	Gaz Tüketim Değeri Gas Consumption Lpg
EMP.9KG020	2,42 m³/h	1,80 kg/h

Türkçe
GAZLI OCAKLAR

- Lpg ve Ng ile çalışabilme özelliği.
- Magnet emniyet ventilli musluklar.
- Darbelere karşı dayanıklı üst döküm.
- Kolay temizlenebilir ve hijyeniktir.
- Paslanmaz çelik gövde.

KAPALI DÖKÜM GAZLI OCAK

- Lpg ve Ng ile çalışabilme özelliği.
- 16 mm üst döküm tabla
- Magnet emniyet ventilli musluklar.
- Piezzo çakmak ile kontrol.
- Kolay temizlenebilir ve hijyeniktir.
- Paslanmaz çelik gövde.

English
GAS COOKERS

- Lpg or Natural Gas.
- Magnet safety valves.
- Heavy duty top cast iron.
- Easy to clean and hygienic.
- Stainless steel body.

SOLID TOP GAS COOKER

- Lpg or Natural Gas.
- Magnet safety gas valve .
- 16 mm top cast plate
- Piezoelectric ignition system.
- Easy to clean and hygienic.
- Stainless steel body.



EMP.9KG020+EMP.9FRG020



EMP.9KG020+EMP.9TS020



EMP.9KG010+EMP.9TS010-K

Gazlı Ocaklar
Gas Cookers



Kod Code	Ürün Adı Description	Ebatlar Dimension mm			Ağırlık Weight kg	Net Net m³	Güç Power kw	Fiyatı Price Euro
		a	b	c				
EMP.9KG030	6 Brülör'lü Gazlı Ocak 6 Burner Gas Cooker	1200	900	285	92	0.31	34.5	2.135

Setüstü / Countertop

Kod Code	Gaz Tüketim Değeri Gas Consumption Ng	Gaz Tüketim Değeri Gas Consumption Lpg
EMP.9KG030	3,63 m³/h	2,70 kg/h

Kod Code	Ürün Adı Description	Ebatlar Dimension mm			Ağırlık Weight kg	Net Net m³	Güç Power kw	Fiyatı Price Euro
		a	b	c				
EMP.9YRG80	4 Yanışlı Ocak 4 Ring Cooker	800	900	285	70	0.21	31.25	1.235

Setüstü / Countertop

Kod Code	Gaz Tüketim Değeri Gas Consumption Ng	Gaz Tüketim Değeri Gas Consumption Lpg
EMP.9YRG80	3,30 m³/h	2,48 kg/h

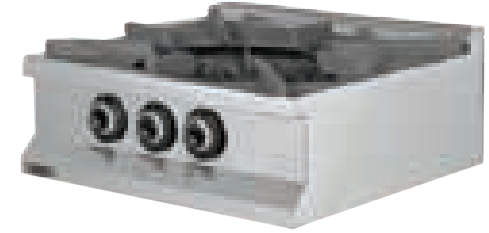

4 YANIŞLI BRULÖR
4 RING HIGH POWER BURNER

Türkçe

GAZLI OCAKLAR

- Lpg ve Ng ile çalışabilme özelliği.
- Magnet emniyet ventilli musluklar.
- Darbelere karşı dayanıklı üst döküm.
- Kolay temizlenebilir ve hijyeniktir.
- Paslanmaz çelik gövde.

English

GAS COOKERS

- Lpg or Natural Gas.
- Magnet safety valves.
- Heavy duty top cast iron.
- Easy to clean and hygienic.
- Stainless steel body.



EMP.9KG030+EMP.9FRG03



EMP.9YRG80+EMP.9TS020

Gazlı Wok Ocakları
 Gas Wok Cookers

Kod Code	Ürün Adı Description	Ebatlar Dimension mm			Ağırlık Weight kg	Net Net m ³	Güç Power kw	Fiyatı Price Euro
		a	b	c				
EMP.9WK010	1 Brülörlü Gazlı Wok Ocağı 1 Burner Gas Wok Cooker	400	900	285	35	0.10	18	850

Setüstü / Countertop

Kod Code	Gaz Tüketim Değeri Gas Consumption Ng	Gaz Tüketim Değeri Gas Consumption Lpg
EMP.9WK010	1,9 m ³ /h	1,05 kg/h

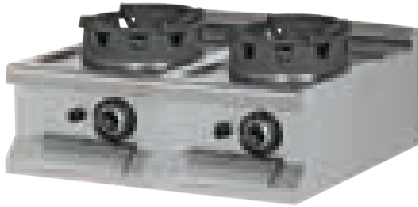

Kod Code	Ürün Adı Description	Ebatlar Dimension mm			Ağırlık Weight kg	Net Net m ³	Güç Power kw	Fiyatı Price Euro
		a	b	c				
EMP.9WK020	2 Brülörlü Gazlı Wok Ocağı 2 Burner Gas Wok Cooker	800	900	285	71	0.21	36	1.450

Setüstü / Countertop

Kod Code	Gaz Tüketim Değeri Gas Consumption Ng	Gaz Tüketim Değeri Gas Consumption Lpg
EMP.9WK020	3,8 m ³ /h	2,10 kg/h

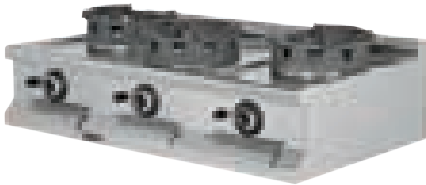

Kod Code	Ürün Adı Description	Ebatlar Dimension mm			Ağırlık Weight kg	Net Net m ³	Güç Power kw	Fiyatı Price Euro
		a	b	c				
EMP.9WK030	3 Brülörlü Gazlı Wok Ocağı 3 Burner Gas Wok Cooker	1200	900	285	105	0.31	54	2.100

Setüstü / Countertop

Kod Code	Gaz Tüketim Değeri Gas Consumption Ng	Gaz Tüketim Değeri Gas Consumption Lpg
EMP.9WK030	5,6 m ³ /h	3,15 kg/h

Türkçe
GAZLI WOK OCAKLARI

- Lpg ve Ng ile çalışabilme özelliği.
- Magnet emniyet ventilli musluklar.
- Darbelere karşı dayanıklı üst döküm.
- Kolay temizlenebilir ve hijyeniktir.
- Paslanmaz çelik gövde.

English
GAS WOK COOKERS

- Lpg or Natural Gas.
- Magnet safety gas valve and thermocouple.
- Heavy duty top cast iron.
- Easy to clean and hygienic.
- Stainless steel body.



EMP.9WK010+EMP.9TS010 EMP.9WK010+EMP.9TS010-K

Elektrikli Ocaklar
Electric Cookers



Kod Code	Ürün Adı Description	Ebatlar Dimension mm			Ağırlık Weight kg	Net Net m³	Güç Power kw	Fiyatı Price Euro
		a	b	c				
EMP.9KE010	2 Pleytli Elektrikli Ocak 2 Hot Plate Electric Cooker	400	900	285	32	0.10	8	920



Setüstü / Countertop

Kod Code	Elektrik Girişi Electric Input	Kablo Kesiti Cable Cross Section mm²
EMP.9KE010	400 V. AC 3N PE	5 X 2,5

Kod Code	Ürün Adı Description	Ebatlar Dimension mm			Ağırlık Weight kg	Net Net m³	Güç Power kw	Fiyatı Price Euro
		a	b	c				
EMP.9KE020	4 Pleytli Elektrikli Ocak 4 Hot Plate Electric Cooker	800	900	285	75	0.21	16	1.545



Setüstü / Countertop

Kod Code	Elektrik Girişi Electric Input	Kablo Kesiti Cable Cross Section mm²
EMP.9KE020	400 V. AC 3N PE	5 X 4

Kod Code	Ürün Adı Description	Ebatlar Dimension mm			Ağırlık Weight kg	Net Net m³	Güç Power kw	Fiyatı Price Euro
		a	b	c				
EMP.9KE030	6 Pleytli Elektrikli Ocak 6 Hot Plate Electric Cooker	1200	900	285	122	0.31	24	2.460



Setüstü / Countertop

Kod Code	Elektrik Girişi Electric Input	Kablo Kesiti Cable Cross Section mm²
EMP.9KE030	400 V. AC 3N PE	5 X 6

Türkçe

ELEKTRİKLİ OCAKLAR

- 6 kademeli şalter.
- Kolay temizlenebilir ve hijyeniktir.
- Paslanmaz çelik gövde.

English

ELECTRIC COOKERS

- 6 position switch.
- Easy to clean and hygienic.
- Stainless steel body.



EMP.9KE020+EMP.9TS020-K

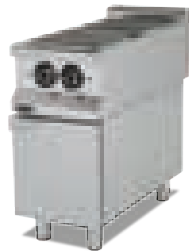

EMP.9KE010+EMP.9TS010



EMP.9KE030+EMP.9FRE02

Elektrikli Fritözler
 Electric Fryers

Kod Code	Ürün Adı Description	Ebatlar Dimension mm			Ağırlık Weight kg	Net Net m³	Güç Power kw	Kapasite Capacity lt	Fiyatı Price Euro
		a	b	c					
EMP.9FE010	Elektrikli Fritöz Electric Fryer	400	900	850	61	0.10	12	24	1.290

Dolaplı / With Cupboard
Havuz içerisinde 2 adet sepet
 2 No's of baskets

Kod Code	Elektrik Girişi Electric Input	Kablo Kesiti Cable Cross Section mm²
EMP.9FE010	400 V. AC 3N PE	5 X 4



Kod Code	Ürün Adı Description	Ebatlar Dimension mm			Ağırlık Weight kg	Net Net m³	Güç Power kw	Kapasite Capacity lt	Fiyatı Price Euro
		a	b	c					
EMP.9FE020	Elektrikli Fritöz Electric Fryer	800	900	850	138	0.21	24	2X24	2.195

Dolaplı / With Cupboard
Havuz içerisinde 2 adet sepet
 2 No's of baskets in each tank

Kod Code	Elektrik Girişi Electric Input	Kablo Kesiti Cable Cross Section mm²
EMP.9FE020	400 V. AC 3N PE	5 X 6



Kod Code	Ürün Adı Description	Ebatlar Dimension mm			Ağırlık Weight kg	Net Net m³	Güç Power kw	Kapasite Capacity lt	Fiyatı Price Euro
		a	b	c					
EMP.9FE010-K	Elektrikli Fritöz Electric Fryer	400	900	850	51	0.10	12	24	1.250

Dolaplı / With Cupboard

Kod Code	Elektrik Girişi Electric Input	Kablo Kesiti Cable Cross Section mm²
EMP.9FE010-K	400 V. AC 3N PE	5 X 4

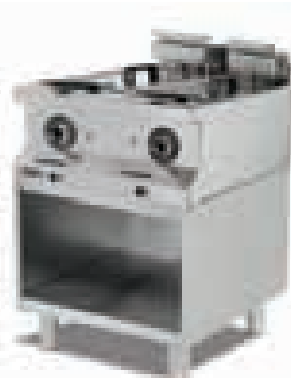

Kod Code	Ürün Adı Description	Ebatlar Dimension mm			Ağırlık Weight kg	Net Net m³	Güç Power kw	Kapasite Capacity lt	Fiyatı Price Euro
		a	b	c					
EMP.9FE020-K	Elektrikli Fritöz Electric Fryer	800	900	850	128	0.21	24	2X24	2.120

Dolaplı / With Cupboard

Kod Code	Elektrik Girişi Electric Input	Kablo Kesiti Cable Cross Section mm²
EMP.9FE020-K	400 V. AC 3N PE	5 X 6

Türkçe
ELEKTRİKLİ FRİTÖZLER

- Termostatik kumanda.
- Paslanmaz çelik sepetler.
- Hareketli ısıtıcılar kolay temizlik imkanı sağlar.
- Boşaltma borusu ile emniyetli yağ boşaltma.
- Limit termostat.
- Kolay temizlenebilir ve hijyeniktir.
- Paslanmaz çelik gövde.

English
ELECTRIC FRYERS

- Thermostatic control.
- Stainless steel baskets.
- Moving heaters provide easy cleaning.
- Safe oil drainage from the bottom via valve.
- Safety thermostat for overheating protection.
- Easy to clean and hygienic.
- Stainless steel body.

Gaslı Fritözler Gas Fryers



Kod Code	Ürün Adı Description	Ebatlar Dimension mm			Ağırlık Weight kg	Net Net m³	Güç Power kw	Kapasite Capacity lt	Fiyatı Price Euro
		a	b	c					
EMP.9FG010	Gaslı Fritöz Gas Fryer	400	900	850	80	0.31	11.63	24	1.400

Dolaplı / With Cupboard

Kod Code	Gaz Tüketim Değeri Gas Consumption Ng	Gaz Tüketim Değeri Gas Consumption Lpg
EMP.9FG010	1,22 m³/h	0,63 kg/h



Kod Code	Ürün Adı Description	Ebatlar Dimension mm			Ağırlık Weight kg	Net Net m³	Güç Power kw	Kapasite Capacity lt	Fiyatı Price Euro
		a	b	c					
EMP.9FG020	Gaslı Fritöz Gas Fryer	800	900	850	138	0.62	23.25	2X24	2.425

Dolaplı / With Cupboard

Kod Code	Gaz Tüketim Değeri Gas Consumption Ng	Gaz Tüketim Değeri Gas Consumption Lpg
EMP.9FG020	2,45 m³/h	1,22 kg/h

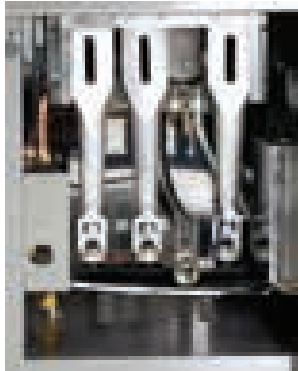

Türkçe

GAZLI FRİTÖZLER

- Lpg ve Ng ile çalışabilme özelliği.
- 220 V 50 Hz. çalışma voltajı.
- Termostatik kumanda.
- Paslanmaz çelik sepetler.
- Magnet emniyet ventilli musluklar.
- Boşaltma borusu ile emniyetli yağ boşaltma.
- Limit termostat.
- Kolay temizlenebilir ve hijyeniktir.
- Paslanmaz çelik gövde.

English

GAS FRYERS

- Lpg or Ng.
- Operating voltage: 220V 50 Hz
- Thermostatic control.
- Stainless steel baskets.
- Magnet safety gas valve and thermocouple.
- Safe oil drainage from the bottom via valve.
- Safety thermostat for overheating protection.
- Easy to clean and hygienic.
- Stainless steel body.

Elektrikli Makarna Haşlama - Patates Dinlendirme
 Electric Pasta Cooker - Chips Scuttle

Kod Code	Ürün Adı Description	Ebatlar Dimension mm			Ağırlık Weight kg	Net Net m³	Güç Power kw	Fiyatı Price Euro
		a	b	c				
EMP.9ME010	Elektrikli Makarna Haşlama Electric Pasta Cooker	400	900	850	60	0.10	12	1.515

Dolaplı / With Cupboard

Kod Code	Elektrik Girişi Electric Input	Kablo Kesiti Cable Cross Section mm²
EMP.9ME010	400 V. AC 3N PE	5 X 4



Kod Code	Ürün Adı Description	Ebatlar Dimension mm			Ağırlık Weight kg	Net Net m³	Güç Power kw	Fiyatı Price Euro
		a	b	c				
EMP.9ME010-K	Elektrikli Makarna Haşlama Electric Pasta Cooker	400	900	850	60	0.10	12	1.480

Dolaplı / With Cupboard

Kod Code	Elektrik Girişi Electric Input	Kablo Kesiti Cable Cross Section mm²
EMP.9ME010-K	400 V. AC 3N PE	5 X 4



Kod Code	Ürün Adı Description	Ebatlar Dimension mm			Ağırlık Weight kg	Net Net m³	Güç Power kw	Fiyatı Price Euro
		a	b	c				
EMP.9DE010	Patates Dinlendirme Chips Scuttle	400	900	285	20	0.10	0.65	520

Setüstü / Countertop

Kod Code	Elektrik Girişi Electric Input	Kablo Kesiti Cable Cross Section mm²
EMP.9DE010	230 V. AC N PE	3 X 1,5

Türkçe
ELEKTRİKLİ MAKARNA HAŞLAMA

- Termostatik kontrol.
- Paslanmaz çelik sepetler.
- Su doldurma musluğu.
- Tahliye musluğu ile su boşaltma .
- Taşan su tahliye sistemi.
- Kolay temizlenebilir ve hijyeniktir.
- Paslanmaz çelik gövde.

PATATES DİNLENDİRME

- Kızartılmış patateslerin sıcak bekletilmesinde ve yağların süzülmesinde kullanılır.
- GN 1/1X150 mm kuvet kapasitesi.
- Infrared seramik ısıtıcı.
- Havuzda kızartma yağının süzülmesi için maksimum verim sağlayan özel form.
- Kolay temizlenebilir ve hijyeniktir.
- Paslanmaz çelik gövde.

English
ELECTRIC PASTA COOKER

- Thermostatic control.
- Stainless steel baskets.
- Water filling tap.
- Discharge valve.
- Overflow drainage system.
- Easy to clean and hygienic.
- Stainless steel body.

CHIPS SCUTTLE

- Operates in order to keep fried food warm and drain oil.
- Capacity: GN 1/1X150 mm
- Ceramic infrared heater.
- Special form on the container, provides maximum efficiency in order to drain oil.
- Easy to clean and hygienic.
- Stainless steel body.



EMP.7DE010+EMP.7TS010

Gazlı Izgaralar
Gas Grills



Kod Code	Ürün Adı Description	Ebatlar Dimension mm			Ağırlık Weight kg	Net Net m ³	Güç Power kw	Fiyatı Price Euro
		a	b	c				
EMP.9IG010	Gazlı Izgara-Düz Gas Grill-Smooth	400	900	285	65	0.10	8.30	710
EMP.9IG010-K	Gazlı Izgara-Krom Tablalı Gas Grill-Chrome Plate	400	900	285	65	0.10	8.30	1.125



Setüstü / Countertop

Kod Code	Gaz Tüketim Değeri Gas Consumption Ng	Gaz Tüketim Değeri Gas Consumption Lpg
EMP.9IG010	0,87 m ³ /h	0,55 kg/h

Kod Code	Ürün Adı Description	Ebatlar Dimension mm			Ağırlık Weight kg	Net Net m ³	Güç Power kw	Fiyatı Price Euro
		a	b	c				
EMP.9IG020	Gazlı Izgara-Düz Gas Grill-Smooth	800	900	285	106	0.21	16.60	1.125
EMP.9IG022	Gazlı Izgara-Düz+Oluklu Gas Grill-Smooth+Ribbed	800	900	285	108	0.21	16.60	1.235
EMP.9IG020-K	Gazlı Izgara-Krom Tablalı Gas Grill-Chrome Plate	800	900	285	106	0.21	16.60	1.740
EMP.9IG022-K	Gazlı Izgara-Krom Tablalı Gas Grill-Chrome Plate	800	900	285	108	0.21	16.60	1.850



Setüstü / Countertop

Kod Code	Gaz Tüketim Değeri Gas Consumption Ng	Gaz Tüketim Değeri Gas Consumption Lpg
EMP.9IG020	1,75 m ³ /h	1,11 kg/h
EMP.9IG022	1,75 m ³ /h	1,11 kg/h



Düz
Smooth



Düz+Oluklu
Smooth+Ribbed

Türkçe

GAZLI IZGARALAR

- Lpg ve Ng ile çalışabilme özelliği.
- Magnet emniyet ventilli ve pilotlu musluklar.
- Tam modüllerde iki bölgeyi ısıtma.
- Her brulör için piezzo çakmak ile kontrol.
- Çıkarılabilir yağ toplama haznesi.
- Kolay temizlenebilir ve hijyeniktir.
- Paslanmaz çelik gövde.

English

GAS GRILLS

- Lpg or Natural Gas.
- Magnet safety gas valve and pilot flame.
- Two separate heating zones.
- Piezoelectric ignition system for each burner.
- Removable oil collecting drawer.
- Easy to clean and hygienic.
- Stainless steel body.

Elektrikli Izgaralar
 Electric Grills



Kod Code	Ürün Adı Description	Ebatlar Dimension mm			Ağırlık Weight kg	Net Net m ³	Güç Power kw	Fiyatı Price Euro
		a	b	c				
EMP.9IE010	Elektrikli Izgara-Düz Electric Grill-Smooth	400	900	285	65	0.10	6	745
EMP.9IE010-K	Elektrikli Izgara-Krom Tablalı Electric Grill-Chrome Plate	400	900	285	65	0.10	6	1.155

Setüstü / Countertop

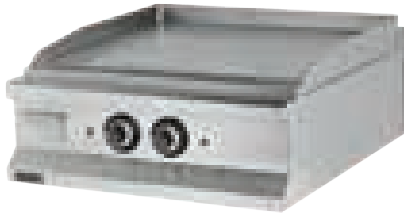
Kod Code	Elektrik Girişi Electric Input	Kablo Kesiti Cable Cross Section mm ²
EMP.9IE010	400 V. AC 3N PE	5 X 2,5

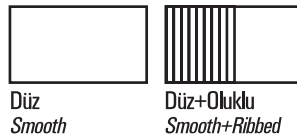

Kod Code	Ürün Adı Description	Ebatlar Dimension mm			Ağırlık Weight kg	Net Net m ³	Güç Power kw	Fiyatı Price Euro
		a	b	c				
EMP.9IE020	Elektrikli Izgara-Düz Electric Grill-Smooth	800	900	285	106	0.21	12	1.235
EMP.9IE022	Elektrikli Izgara-Düz+Oluklu Electric Grill-Smooth+Ribbed	800	900	285	108	0.21	12	1.350
EMP.9IE020-K	Elektrikli Izgara-Krom Tablalı Electric Grill-Chrome Plate	800	900	285	106	0.21	12	1.850
EMP.9IE022-K	Elektrikli Izgara-Krom Tablalı Electric Grill-Chrome Plate	800	900	285	108	0.21	12	1.965

Setüstü / Countertop

Kod Code	Elektrik Girişi Electric Input	Kablo Kesiti Cable Cross Section mm ²
EMP.9IE020	400 V. AC 3N PE	5 X 4
EMP.9IE022	400 V. AC 3N PE	5 X 4

Türkçe
ELEKTRİKLİ IZGARALAR

- Termostatik kumanda.
- Tam modüllerde iki bölgeyi ısıtma.
- Çıkarılabilir yağ toplama haznesi
- Kolay temizlenebilir ve hijyeniktir.
- Paslanmaz çelik gövde.

English
ELECTRIC GRILLS

- Thermostatic controller.
- Two separate heating zones.
- Removable oil collecting drawer.
- Easy to clean and hygienic.
- Stainless steel body.



EMP.9 IE010+EMP.9TS010



EMP.9IE020+EMP.9TS020-K

Gazlı Lavataşlı Izgaralar Gas Lavastone Grills



Kod Code	Ürün Adı Description	Ebatlar Dimension mm			Ağırlık Weight kg	Net Net m³	Güç Power kw	Fiyatı Price Euro
		a	b	c				
EMP.9LG010	Lavataşlı Izgara - Gazlı Lavastone Grills - Gas	400	900	285	50	0.10	10.30	730

Setüstü / Countertop

Kod Code	Gaz Tüketim Değeri Gas Consumption Ng	Gaz Tüketim Değeri Gas Consumption Lpg
EMP.9LG010	1,09 m³/h	0,77 kg/h



Kod Code	Ürün Adı Description	Ebatlar Dimension mm			Ağırlık Weight kg	Net Net m³	Güç Power kw	Fiyatı Price Euro
		a	b	c				
EMP.9LG020	Lavataşlı Izgara - Gazlı Lavastone Grills - Gas	800	900	285	95	0.21	20.60	1.255

Setüstü / Countertop

Kod Code	Gaz Tüketim Değeri Gas Consumption Ng	Gaz Tüketim Değeri Gas Consumption Lpg
EMP.9LG020	2.18 m³/h	0,86 kg/h



Döküm üst ızgara Cast iron top

Türkçe

GAZLI LAVATAŞLI IZGARALAR

- Lpg ve Ng ile çalışabilme özelliği.
- Magnet emniyet ventilli ve pilotlu musluklar.
- Tam modüllerde iki bölgeyi ısıtma.
- Her brülör için piezzo çakmak ile kontrol.
- Çıkarılabilir yağ toplama haznesi.
- Kolay temizlenebilir ve hijyeniktir.
- Paslanmaz çelik gövde.

English

GAS LAVASTONE GRILLS

- Lpg or Ng.
- Magnet safety gas valve and pilot flame.
- Two separate heating zones.
- Piezoelectric ignition system for each burner.
- Removable oil collecting drawer.
- Easy to clean and hygienic.
- Stainless steel body.



EMP.9LG020+EMP.9TS020



EMP.9LG010+EMP.9TS010-K

Gazlı Sulu Izgara
 Gas Vapor Grill

Kod Code	Ürün Adı Description	Ebatlar Dimension mm			Ağırlık Weight kg	Net Net m³	Güç Power kw	Fiyatı Price Euro
		a	b	c				
EMP.9LG010-S	Gazlı Sulu Izgara Gas Vapor Grill	400	900	285	50	0.10	7	840

Setüstü / Countertop

Kod Code	Gaz Tüketim Değeri Gas Consumption Ng	Gaz Tüketim Değeri Gas Consumption Lpg
EMP.9LG010-S	0,75 m³/h	0,87 kg/h



Kod Code	Ürün Adı Description	Ebatlar Dimension mm			Ağırlık Weight kg	Net Net m³	Güç Power kw	Fiyatı Price Euro
		a	b	c				
EMP.9LG020-S	Gazlı Sulu Izgara Gas Vapor Grill	800	900	285	95	0.21	14	1.350

Setüstü / Countertop

Kod Code	Gaz Tüketim Değeri Gas Consumption Ng	Gaz Tüketim Değeri Gas Consumption Lpg
EMP.9LG020-S	1,5 m³/h	1,74 kg/h

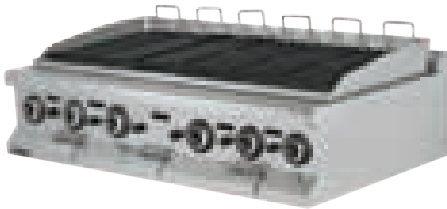

Kod Code	Ürün Adı Description	Ebatlar Dimension mm			Ağırlık Weight kg	Net Net m³	Güç Power kw	Fiyatı Price Euro
		a	b	c				
EMP.9LG030-S	Gazlı Sulu Izgara Gas Vapor Grill	1200	900	285	120	0.31	21	1.935

Setüstü / Countertop

Kod Code	Gaz Tüketim Değeri Gas Consumption Ng	Gaz Tüketim Değeri Gas Consumption Lpg
EMP.9LG030-S	2,25 m³/h	2,61 kg/h

Türkçe
GAZLI SULU IZGARA

- Buharlaştırma kabini sayesinde daha verimli pişirme.
- Lpg ve Ng ile çalışabilme özelliği.
- Magnet emniyet ventilli ve pilotlu musluklar.
- Tam modüllerde iki bölgeyi ısıtma.
- Her brülör için piezo çakmak ile kontrol.
- Pisk döküm ızgara.
- Kolay temizlenebilir ve hijyeniktir.
- Paslanmaz çelik gövde.

English
GAS VAPOR GRILL

- Steamer cabinet provides fertile cooking.
- Lpg or Natural Gas.
- Magnet safety gas valve and pilot flame.
- Two separate heating zones.
- Piezoelectric ignition system for each burner.
- Cast iron plate.
- Easy to clean and hygienic.
- Stainless steel body.

Elektrikli Benmariler
Electric Bain maries



Kod Code	Ürün Adı Description	Ebatlar Dimension mm			Ağırlık Weight kg	Net Net m³	Güç Power kw	Fiyatı Price Euro
		a	b	c				
EMP.9SE010	Elektrikli Benmari Electric Bain marie	400	900	850	57	0.10	2	880

Dolaplı / With Cupboard

Kod Code	Elektrik Girişi Electric Input	Kablo Kesiti Cable Cross Section mm²
EMP.9SE010	230 V. AC N PE	3 X 1,5

Kod Code	Ürün Adı Description	Ebatlar Dimension mm			Ağırlık Weight kg	Net Net m³	Güç Power kw	Fiyatı Price Euro
		a	b	c				
EMP.9SE020	Elektrikli Benmari Electric Bain marie	800	900	850	110	0.21	4	1.460

Dolaplı / With Cupboard

Kod Code	Elektrik Girişi Electric Input	Kablo Kesiti Cable Cross Section mm²
EMP.9SE020	230 V. AC N PE	3 X 2,5

Kod Code	Ürün Adı Description	Ebatlar Dimension mm			Ağırlık Weight kg	Net Net m³	Güç Power kw	Fiyatı Price Euro
		a	b	c				
EMP.9SE010-K	Elektrikli Benmari Electric Bain marie	400	900	850	47	0.10	2	845

Dolaplı / With Cupboard

Kod Code	Elektrik Girişi Electric Input	Kablo Kesiti Cable Cross Section mm²
EMP.9SE010-K	230 V. AC N PE	3 X 1,5

Kod Code	Ürün Adı Description	Ebatlar Dimension mm			Ağırlık Weight kg	Net Net m³	Güç Power kw	Fiyatı Price Euro
		a	b	c				
EMP.9SE020-K	Elektrikli Benmari Electric Bain marie	800	900	850	100	0.21	4	1.380

Dolaplı / With Cupboard

Kod Code	Elektrik Girişi Electric Input	Kablo Kesiti Cable Cross Section mm²
EMP.9SE020-K	230 V. AC N PE	3 X 2,5

*Standart üretimimizde küvet bulunmamaktadır.

*Standart product does not have containers.

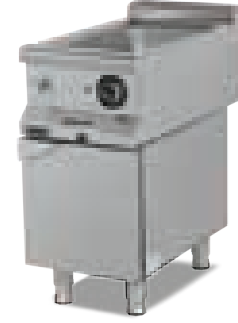

Türkçe

ELEKTRİKLİ BENMARİLER

- Termostatik kumanda.
- Yarım modülde 1 adet GN1/1.
- Tam modülde ise 2 adet GN1/1.
- Tahliye musluğu.
- Su alma musluğu.
- Kolay temizlenebilir ve hijyeniktir.
- Paslanmaz çelik gövde.

English

ELECTRIC BAIN MARIES

- Thermostatic controller.
- Capacity of half modul; 1 piece of GN1/1.
- Capacity of full modul; 2 pieces of GN1/1.
- Drainage valve.
- Water inlet valve.
- Easy to clean and hygienic.
- Stainless steel body.

Ara Tezgahlar
Work Top

Kod Code	Ürün Adı Description	Ebatlar Dimension mm			Ağırlık Weight kg	Net Net m ³	Fiyatı Price Euro
		a	b	c			
EMP.9TN010	Ara Tezgah Work Top	400	900	285	17	0.10	280

Setüstü / Countertop

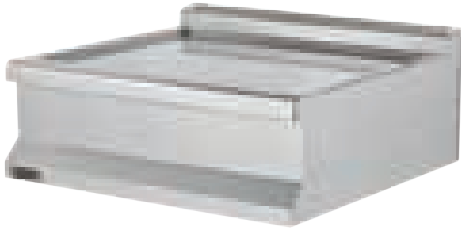

Kod Code	Ürün Adı Description	Ebatlar Dimension mm			Ağırlık Weight kg	Net Net m ³	Fiyatı Price Euro
		a	b	c			
EMP.9TN020	Ara Tezgah Work Top	800	900	285	34	0.21	475

Setüstü / Countertop

Türkçe

ARA TEZGAHLAR

- Tezgah üst yüzeyleri ara ya da ön hazırlıklar için idealdir.
- Kolay temizlenebilir ve hijyeniktir.
- Paslanmaz çelik gövde.

English

WORK TOP WITH CABINET

- Provides preliminary preparation by upper surfaces.
- Easy to clean and hygienic.
- Stainless steel body.



Set Altı Tezgah - Kapaklı
Undercounter Cabinet - With Door



Tablo/Table

Kod Code	Ürün Adı Description	Ebatlar Dimension mm			Ağırlık Weight kg	Net Net m³	Fiyatı Price Euro
		a	b	c			
EMP.9TS010	Set Altı Tezgah Undercounter Cabinet	400x847x565			21	0.10	255



Kod Code	Ürün Adı Description	Ebatlar Dimension mm			Ağırlık Weight kg	Net Net m³	Fiyatı Price Euro
		a	b	c			
EMP.9TS020	Set Altı Tezgah Undercounter Cabinet	800x847x565			30	0.21	365



Kod Code	Ürün Adı Description	Ebatlar Dimension mm			Ağırlık Weight kg	Net Net m³	Fiyatı Price Euro
		a	b	c			
EMP.9TS030	Set Altı Tezgah Undercounter Cabinet	1200x847x565			38	0.31	575



Set Altı Tezgah - Kapaksız
Undercounter Cabinet - Without Door



Kod Code	Ürün Adı Description	Ebatlar Dimension mm			Ağırlık Weight kg	Net Net m ³	Fiyatı Price Euro
		a	b	c			
EMP.9TS010-K	Set Altı Tezgah - Kapaksız Undercounter Cabinet - Without Door	400	847	565	21	0.14	220

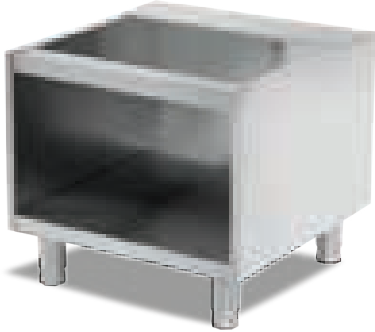

Kod Code	Ürün Adı Description	Ebatlar Dimension mm			Ağırlık Weight kg	Net Net m ³	Fiyatı Price Euro
		a	b	c			
EMP.9TS020-K	Set Altı Tezgah - Kapaksız Undercounter Cabinet - Without Door	800	847	565	30	0.27	290

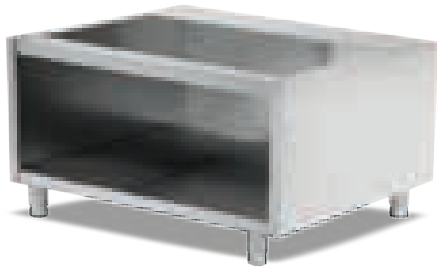

Kod Code	Ürün Adı Description	Ebatlar Dimension mm			Ağırlık Weight kg	Net Net m ³	Fiyatı Price Euro
		a	b	c			
EMP.9TS030-K	Set Altı Tezgah - Kapaksız Undercounter Cabinet - Without Door	1200	847	565	38	0.41	460

Set Altı Fırınlar - Gazlı
Ovens - Gas



Kod Code	Ürün Adı Description	Ebatlar Dimension mm			Ağırlık Weight kg	Net Net m³	Güç Power kw	Fiyatı Price Euro
		a	b	c				
EMP.9FRG01	Set Altı Fırınlar - Gazlı Ovens - Gas	800	847	565	60	0.27	6.46	1.030



Kod Code	Ürün Adı Description	Ebatlar Dimension mm			Ağırlık Weight kg	Net Net m³	Güç Power kw	Fiyatı Price Euro
		a	b	c				
EMP.9FRG02	Set Altı Fırınlar - Gazlı Ovens - Gas	1200	847	565	80	0.41	6.46	1.210



Kod Code	Ürün Adı Description	Ebatlar Dimension mm			Ağırlık Weight kg	Net Net m³	Güç Power kw	Fiyatı Price Euro
		a	b	c				
EMP.9FRG03	Set Altı Maxi Fırınlar - Gazlı Maxi Ovens - Gas	1200	847	565	90	0.41	12.93	1.545



Türkçe

SET ALTI FIRINLAR - GAZLI

- Lpg ve Ng ile çalışabilme özelliği.
- 2xGN 2/1 tepsi kapasiteli paslanmaz çelik fırın iç haznesi.
- Termostatik ayarlı fırın gaz ventilli.

English

OVENS - GAS

- Lpg or Natural Gas
- 2xGN 2/1 capacity, stainless steel internal chamber.
- For oven temperature control with thermostatic gas valve.

Set Altı Fırınlar - Elektrikli
 Ovens - Electric

Kod Code	Ürün Adı Description	Ebatlar Dimension mm			Ağırlık Weight kg	Net Net m ³	Güç Power kw	Fiyatı Price Euro
		a	b	c				
EMP.9FRE01	Set Altı Fırınlar - Elektrikli Ovens - Electric	800	847	565	60	0.27	9	980



Kod Code	Ürün Adı Description	Ebatlar Dimension mm			Ağırlık Weight kg	Net Net m ³	Güç Power kw	Fiyatı Price Euro
		a	b	c				
EMP.9FRE02	Set Altı Fırınlar - Elektrikli Ovens - Electric	1200	847	565	80	0.41	9	1.210



Kod Code	Ürün Adı Description	Ebatlar Dimension mm			Ağırlık Weight kg	Net Net m ³	Güç Power kw	Fiyatı Price Euro
		a	b	c				
EMP.9FRE03	Set Altı Maxi Fırınlar - Elektrikli Maxi Ovens - Electric	1200	847	565	90	0.41	15	1.545

Türkçe
SET ALTI FIRINLAR - ELEKTRİKLİ

- 2xGN 2/1 tepsi kapasiteli paslanmaz çelik fırın iç haznesi.

English
OVENS - ELECTRIC

- 2xGN 2/1 capacity, stainless steel internal chamber.

Kaynatma Tencereleri (İndirekt) Boiling Pans (Indirect)



Kod Code	Ürün Adı Description	Ebatlar Dimension mm			Ağırlık Weight kg	Net Net m³	Güç Power kw	Kapasite Capacity lt	Fiyatı Price Euro
		a	b	c					
EMP.KTG.150	Kaynatma Tenceresi (Gazlı) Boiling Pan (Gas)	800	900	850	155	0.62	16.10	150	4.700
EMP.KTE.150	Kaynatma Tenceresi (Elektrikli) Boiling Pan (Electrical)	800	900	850	100	0.62	18	150	4.700
EMP.KTG.250	Kaynatma Tenceresi (Gazlı) Boiling Pan (Gas)	1200	900	850	250	0.92	32.20	250	6.740
EMP.KTE.250	Kaynatma Tenceresi (Elektrikli) Boiling Pan (Electrical)	1200	900	850	190	0.92	30	250	6.740

Kod Code	Elektrik Girişi Electric Input V	Kablo Kesiti Cable Cross Section mm²
EMP.KTE.150	380	5x6
EMP.KTE.250	380	5x10

Kod Code	Gaz Tüketim Değeri Gas Consumption Ng	Gaz Tüketim Değeri Gas Consumption Lpg
EMP.KTG.150	1,70 m³/h	1,21 kg/h
EMP.KTG.250	3,40 m³/h	2,42 kg/h

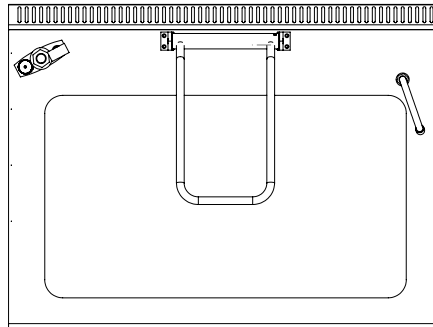

EMP.KTE.250 ve EMP.KTG.250 dikdörtgen modeldir.
EMP.KTE.250 and EMP.KTG.250 are made rectangular type.



Türkçe

KAYNATMA TENCERELERİ (GAZLI)

- Lpg ve Ng ile çalışabilme özelliği.
- Magnet emniyet ventilli termokup ve termostat.
- Aşırı basınç valfi ve manometre.
- Soğuk, sıcak su doldurma musluğu.
- Tahliye Musluğu.
- Karşı ağırlıklı kapak.
- Çift cidarlı ceket.
- Kolay temizlenebilir ve hijyeniktir.
- Paslanmaz çelik gövde.

KAYNATMA TENCERELERİ (ELEKTRİKLİ)

- Aşırı basınç valfi ve manometre.
- Soğuk, sıcak su doldurma musluğu.
- Tahliye Musluğu.
- Karşı ağırlıklı kapak.
- Çift cidarlı ceket.
- Kolay temizlenebilir ve hijyeniktir.
- Paslanmaz çelik gövde.

English

BOILING PANS (GAS)

- Lpg or Natural Gas.
- Safety gas valve thermocouple and thermostat.
- Over pressure safety valve and manometer.
- Cold, hot water inlet valve.
- Drainage valve.
- Counterweighted hinged lid.
- Double jacket pan.
- Easy to clean and hygienic.
- Stainless steel body.

BOILING PANS (ELECTRICAL)

- Over pressure safety valve and manometer.
- Cold, hot water inlet valve.
- Drainage valve.
- Counterweighted hinged lid.
- Double jacket pan.
- Easy to clean and hygienic.
- Stainless steel body.

Devrilir Tavalar
Tilting Pans



Kod Code	Ürün Adı Description	Ebatlar Dimension mm			Ağırlık Weight kg	Net Net m³	Güç Power kw	Kapasite Capacity lt	Fiyatı Price Euro
		a	b	c					
EMP.DTG.80	Devrilir Tava (Gazlı) Tilting Pan (Gas)	800x900x850			145	0.62	11.20	80	3.155
EMP.DTE.80	Devrilir Tava (Elektrikli) Tilting Pan (Electrical)	800x900x850			138	0.62	12	80	3.155
EMP.DTG.120	Devrilir Tava (Gazlı) Tilting Pan (Gas)	1200x900x850			215	0.92	16.10	120	4.225
EMP.DTE.120	Devrilir Tava (Elektrikli) Tilting Pan (Electrical)	1200x900x850			208	0.92	12	120	4.225

Kod Code	Elektrik Girişi Electric Input V	Kablo Kesiti Cable Cross Section mm²
EMP.DTE.80	380	5x4
EMP.DTE.120	380	5x6

Kod Code	Gaz Tüketim Değeri Gas Consumption Ng	Gaz Tüketim Değeri Gas Consumption Lpg
EMP.DTG.80	1,18 m³/h	0,98 kg/h
EMP.DTG.120	1,70 m³/h	1,21 kg/h

Türkçe

DEVİRİLİR TAVALAR (GAZLI)

- Lpg ve Ng ile çalışabilme özelliği.
- Magnet emniyet ventilli termokulp ve termostat.
- Manuel kaldırma mekanizması.
- Karşı ağırlıklı kapak.
- Güvenlik sensörü.
- Kolay temizlenebilir ve hijyeniktir.
- Paslanmaz çelik gövde.

DEVİRİLİR TAVALAR (ELEKTRİKLİ)

- Manuel kaldırma mekanizması.
- Karşı ağırlıklı kapak.
- Güvenlik sensörü.
- Kolay temizlenebilir ve hijyeniktir.
- Paslanmaz çelik gövde.

English

TILTING PANS (GAS)

- Lpg or Natural Gas.
- Safety gas valve thermocouple and thermostat.
- Manuel lift system.
- Counterweighted hinged lid.
- Safety switch.
- Easy to clean and hygienic.
- Stainless steel body.

TILTING PANS (ELECTRICAL)

- Manuel lift system.
- Counterweighted hinged lid.
- Safety switch.
- Easy to clean and hygienic.
- Stainless steel body.





900+ *Serisi*
900+ Serie



1,5' in Mutfak / Kitchen of Business

empero@empero.com.tr

900 Plus Serisi
900 Plus Serie



- * **Gazlı Ocaklar / Gas Cookers**
- * **Gazlı Ocaklar / Gas Cookers**
- * **Gazlı Wok Ocakları / Gas Wok Ranges**
- * **Elektrikli Ocaklar / Electric Cookers**
- * **Elektrikli Fritözler / Electric Fryers**
- * **Gazlı Fritözler / Gas Fryers**
- * **Elektrikli Makarna Haşlama - Patates Dinlendirme / Electric Pasta Cooker - Chips Scuttle**
- * **Gazlı Izgaralar / Gas Grills**
- * **Elektrikli Izgaralar / Electric Grills**
- * **Gazlı Lavataşlı Izgaralar / Gas Lavastone Grills**
- * **Gazlı Sulu Izgara / Gas Vapor Grill**
- * **Elektrikli Benmariler / Electric Bain maries**
- * **Ara Tezgahlar / Undercounter Worktop**
- * **Set Altı Dolaplar / Undercounter Cabinets**
- * **Set Altı Fırınlar - Gazlı / Ovens - Gas**
- * **Set Altı Fırınlar - Elektrikli / Ovens - Electric**
- * **Devrilir Tavalar / Tilting Pans**
- * **Kaynatma Tencereleri (İndirekt) / Boiling Pans (Indirect)**
- * **Cantilever Hat / Cantilever Line**
- * **Paslanmaz Alt Bazalar / Stainless Steel Box Spring**

Gazlı Ocaklar
Gas Cookers



Kod Code	Ürün Adı Description	Ebatlar Dimension mm			Ağırlık Weight kg	Net Net m³	Güç Power kw	Fiyatı Price Euro
		a	b	c				
EMP.PLS.9KG020-O	Kapalı Döküm Gazlı Ocak Solid Top Gas Cooker	800	900	285	60	0.21	11.2	1.610

Setüstü / Countertop

Kod Code	Gaz Tüketim Değeri Gas Consumption Ng	Gaz Tüketim Değeri Gas Consumption Lpg
EMP.PLS.9KG020-O	1,4 m³/h	1,1 kg/h

Kod Code	Ürün Adı Description	Ebatlar Dimension mm			Ağırlık Weight kg	Net Net m³	Güç Power kw	Fiyatı Price Euro
		a	b	c				
EMP.PLS.9KG010	2 Brülör'lü Gazlı Ocak 2 Burner Gas Cooker	400	900	300	40	0.11	11.50	975

Setüstü / Countertop

Kod Code	Gaz Tüketim Değeri Gas Consumption Ng	Gaz Tüketim Değeri Gas Consumption Lpg
EMP.PLS.9KG010	1,21 m³/h	0,90 kg/h



Kod Code	Ürün Adı Description	Ebatlar Dimension mm			Ağırlık Weight kg	Net Net m³	Güç Power kw	Fiyatı Price Euro
		a	b	c				
EMP.PLS.9KG020	4 Brülör'lü Gazlı Ocak 4 Burner Gas Cooker	800	900	300	82	0.22	23	1.780

Setüstü / Countertop

Kod Code	Gaz Tüketim Değeri Gas Consumption Ng	Gaz Tüketim Değeri Gas Consumption Lpg
EMP.PLS.9KG020	2,42 m³/h	1,80 kg/h



EMP.PLS.9KG020+EMP.PLS.9TS020 EMP.PLS.9KG020+EMP.PLS.9FRG01

Türkçe

GAZLI OCAKLAR

- Lpg ve Ng ile çalışabilme özelliği.
- Magnet emniyet ventilli musluklar.
- Darbelere karşı dayanıklı üst döküm.
- Kolay temizlenebilir ve hijyeniktir.
- Paslanmaz çelik gövde.

KAPALI DÖKÜM GAZLI OCAK

- Lpg ve Ng ile çalışabilme özelliği.
- 16 mm üst döküm tabla
- Magnet emniyet ventilli musluklar.
- Piezzo çakmak ile kontrol.
- Kolay temizlenebilir ve hijyeniktir.
- Paslanmaz çelik gövde.

English

GAS COOKERS

- Lpg or Natural Gas
- Magnet safety valves.
- Heavy duty top cast iron.
- Easy to clean and hygienic.
- Stainless steel body.

SOLID TOP GAS COOKER

- Lpg or Natural Gas.
- Magnet safety gas valve .
- 16 mm top cast plate
- Piezoelectric ignition system.
- Easy to clean and hygienic.
- Stainless steel body.

2 mm üst tabla kalınlığı
2 mm top thickness

Gazlı Ocaklar
 Gas Cookers

Kod Code	Ürün Adı Description	Ebatlar Dimension mm			Ağırlık Weight kg	Net Net m³	Güç Power kw	Fiyatı Price Euro
		a	b	c				
EMP.PLS.9KG030	6 Brülör'lü Gazlı Ocak 6 Burner Gas Cooker	1200	900	300	120	0.32	34.5	2.560

Setüstü / Countertop

Kod Code	Gaz Tüketim Değeri Gas Consumption Ng	Gaz Tüketim Değeri Gas Consumption Lpg
EMP.PLS.9KG030	3,63 m³/h	2,70 kg/h



Kod Code	Ürün Adı Description	Ebatlar Dimension mm			Ağırlık Weight kg	Net Net m³	Güç Power kw	Fiyatı Price Euro
		a	b	c				
EMP.PLS.9YRG80	4 Yanırlı Ocak 4 Ring Cooker	800	900	300	90	0.21	31.25	1.425

Setüstü / Countertop

Kod Code	Gaz Tüketim Değeri Gas Consumption Ng	Gaz Tüketim Değeri Gas Consumption Lpg
EMP.PLS.9YRG80	3,3 m³/h	2,25 kg/h

Türkçe
GAZLI OCAKLAR

- Lpg ve Ng ile çalışabilme özelliği.
- Magnet emniyet ventilli musluklar.
- Darbelere karşı dayanıklı üst döküm.
- Kolay temizlenebilir ve hijyeniktir.
- Paslanmaz çelik gövde.

2 mm üst tabla kalınlığı
2 mm top thickness
English
GAS COOKERS

- Lpg or Natural Gas.
- Magnet safety valves.
- Heavy duty top cast iron.
- Easy to clean and hygienic.
- Stainless steel body.

4 YANIŞLI BRULÖR
4 RING HIGH POWER BURNER

EMP.PLS.9KG030+EMP.PLS.9FRG03



EMP.PLS.9YRG80+EMP.PLS.9TS020

Gazlı Wok Ocakları
Gas Wok Cookers



Kod Code	Ürün Adı Description	Ebatlar Dimension mm			Ağırlık Weight kg	Net Net m³	Güç Power kw	Fiyatı Price Euro
		a	b	c				
EMP.PLS.9WK010	1 Brülörlü Gazlı Wok Ocağı 1 Burner Gas Wok Cooker	400	900	300	40	0.11	18	950

Setüstü / Countertop

Kod Code	Gaz Tüketim Değeri Gas Consumption Ng	Gaz Tüketim Değeri Gas Consumption Lpg
EMP.PLS.9WK010	1,9 m³/h	1,05 kg/h



Kod Code	Ürün Adı Description	Ebatlar Dimension mm			Ağırlık Weight kg	Net Net m³	Güç Power kw	Fiyatı Price Euro
		a	b	c				
EMP.PLS.9WK020	2 Brülörlü Gazlı Wok Ocağı 2 Burner Gas Wok Cooker	800	900	300	79	0.22	36	1.600

Setüstü / Countertop

Kod Code	Gaz Tüketim Değeri Gas Consumption Ng	Gaz Tüketim Değeri Gas Consumption Lpg
EMP.PLS.9WK020	3,8 m³/h	2,10 kg/h



Kod Code	Ürün Adı Description	Ebatlar Dimension mm			Ağırlık Weight kg	Net Net m³	Güç Power kw	Fiyatı Price Euro
		a	b	c				
EMP.PLS.9WK030	3 Brülörlü Gazlı Wok Ocağı 3 Burner Gas Wok Cooker	1200	900	300	115	0.32	54	2.300

Setüstü / Countertop

Kod Code	Gaz Tüketim Değeri Gas Consumption Ng	Gaz Tüketim Değeri Gas Consumption Lpg
EMP.PLS.9WK030	5,6 m³/h	3,15 kg/h



EMP.PLS.9WK010+EMP.PLS.9TS010

EMP.PLS.9WK020+EMP.PLS.9TS020

2 mm üst tabla kalınlığı
2 mm top thickness

Elektrikli Ocaklar
 Electric Cookers

Kod Code	Ürün Adı Description	Ebatlar Dimension mm			Ağırlık Weight kg	Net Net m ³	Güç Power kw	Fiyatı Price Euro
		a	b	c				
EMP.PLS.9KE010	2 Pleytli Elektrikli Ocak 2 Hot Plate Electric Cooker	400	900	300	45	0.11	8	1.110

Setüstü / Countertop

Kod Code	Elektrik Girişi Electric Input	Kablo Kesiti Cable Cross Section mm ²
EMP.PLS.9KE010	400 V. AC 3N PE	5 X 2,5



Kod Code	Ürün Adı Description	Ebatlar Dimension mm			Ağırlık Weight kg	Net Net m ³	Güç Power kw	Fiyatı Price Euro
		a	b	c				
EMP.PLS.9KE020	4 Pleytli Elektrikli Ocak 4 Hot Plate Electric Cooker	800	900	300	90	0.22	16	1.855

Setüstü / Countertop

Kod Code	Elektrik Girişi Electric Input	Kablo Kesiti Cable Cross Section mm ²
EMP.PLS.9KE020	400 V. AC 3N PE	5 X 4



Kod Code	Ürün Adı Description	Ebatlar Dimension mm			Ağırlık Weight kg	Net Net m ³	Güç Power kw	Fiyatı Price Euro
		a	b	c				
EMP.PLS.9KE030	6 Pleytli Elektrikli Ocak 6 Hot Plate Electric Cooker	1200	900	300	125	0.32	24	2.920

Setüstü / Countertop

Kod Code	Elektrik Girişi Electric Input	Kablo Kesiti Cable Cross Section mm ²
EMP.PLS.9KE030	400 V. AC 3N PE	5 X 6

Türkçe
ELEKTRİKLİ OCAKLAR

- 6 kademeli şalter.
- Kolay temizlenebilir ve hijyeniktir.
- Paslanmaz çelik gövde.

2 mm üst tabla kalınlığı
2 mm top thickness
English
ELECTRIC COOKERS

- 6 position switch.
- Easy to clean and hygienic.
- Stainless steel body.



EMP.PLS.9KE030+EMP.PLS.9FRE020



EMP.PLS.9KE020+EMP.PLS.9TS020



EMP.PLS.9KE010+EMP.PLS.9TS010

Elektrikli Fritözler Electric Fryers



Kod Code	Ürün Adı Description	Ebatlar Dimension mm			Ağırlık Weight kg	Net Net m ³	Güç Power kw	Kapasite Capacity lt	Fiyatı Price Euro
		a	b	c					
EMP.PLS.9FE010	Elektrikli Fritöz Electric Fryer	400	900	850	70	0.11	18	24	1.550

Dolaplı / With Cupboard

Kod Code	Elektrik Girişi Electric Input	Kablo Kesiti Cable Cross Section mm ²
EMP.PLS.9FE010	400 V. AC 3N PE	5 X 4



Kod Code	Ürün Adı Description	Ebatlar Dimension mm			Ağırlık Weight kg	Net Net m ³	Güç Power kw	Kapasite Capacity lt	Fiyatı Price Euro
		a	b	c					
EMP.PLS.9FE020	Elektrikli Fritöz Electric Fryer	800	900	850	140	0.22	36	2X24	2.645

Dolaplı / With Cupboard

Kod Code	Elektrik Girişi Electric Input	Kablo Kesiti Cable Cross Section mm ²
EMP.PLS.9FE020	400 V. AC 3N PE	5 X 6



2 mm üst tabla kalınlığı
2 mm top thickness

Türkçe

ELEKTRİKLİ FRİTÖZLER

- Termostatik kumanda.
- Paslanmaz çelik sepetler.
- Hareketli ısıtıcılar kolay temizlik imkanı sağlar.
- Boşaltma borusu ile emniyetli yağ boşaltma.
- Limit termostat.
- Kolay temizlenebilir ve hijyeniktir.
- Paslanmaz çelik gövde.

English

ELECTRIC FRYERS

- Thermostatic control.
- Stainless steel baskets.
- Moving heaters provide easy cleaning.
- Safe oil drainage from the bottom via valve.
- Safety thermostat for overheating protection.
- Easy to clean and hygienic.
- Stainless steel body.



Gazlı Fritözler
 Gas Fryers

Kod Code	Ürün Adı Description	Ebatlar Dimension mm			Ağırlık Weight kg	Net Net m ³	Güç Power kw	Kapasite Capacity lt	Fiyatı Price Euro
		a	b	c					
EMP.PLS.9FG010	Gazlı Fritöz Gas Fryer	400	900	850	80	0.31	11.63	24	1.715

Dolaplı / With Cupboard

Kod Code	Gaz Tüketim Değeri Gas Consumption Ng	Gaz Tüketim Değeri Gas Consumption Lpg
EMP.PLS.9FG010	1,22 m ³ /h	0,61 kg/h



Kod Code	Ürün Adı Description	Ebatlar Dimension mm			Ağırlık Weight kg	Net Net m ³	Güç Power kw	Kapasite Capacity lt	Fiyatı Price Euro
		a	b	c					
EMP.PLS.9FG020	Gazlı Fritöz Gas Fryer	800	900	850	155	0.62	23.25	2X24	2.920

Dolaplı / With Cupboard

Kod Code	Gaz Tüketim Değeri Gas Consumption Ng	Gaz Tüketim Değeri Gas Consumption Lpg
EMP.PLS.9FG020	2,45 m ³ /h	1,22 kg/h

Türkçe
GAZLI FRİTÖZLER

- Lpg ve Ng ile çalışabilme özelliği.
- 220 V 50 Hz. çalışma voltajı.
- Termostatik kumanda.
- Paslanmaz çelik sepetler.
- Magnet emniyet ventilli musluklar.
- Boşaltma borusu ile emniyetli yağ boşaltma.
- Limit termostat.
- Kolay temizlenebilir ve hijyeniktir.
- Paslanmaz çelik gövde.

English
GAS FRYERS

- Lpg or Ng.
- Operating voltage: 220V 50 Hz.
- Thermostatic control.
- Stainless steel baskets.
- Magnet safety gas valve and thermocouple.
- Safe oil drainage from the bottom via valve.
- Safety thermostat for overheating protection.
- Easy to clean and hygienic.
- Stainless steel body.

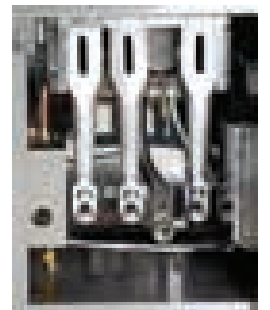
2 mm üst tabla kalınlığı
2 mm top thickness

Elektrikli Makarna Haşlama - Patates Dinlendirme Electric Pasta Cooker - Chips Scuttle



Kod Code	Ürün Adı Description	Ebatlar Dimension mm			Ağırlık Weight kg	Net Net m³	Güç Power kw	Fiyatı Price Euro
		a	b	c				
EMP.PLS.9ME010	Elektrikli Makarna Haşlama Electric Pasta Cooker	400	900	850	80	0.11	12	1.800

Dolaplı / With Cupboard

Kod Code	Elektrik Girişi Electric Input	Kablo Kesiti Cable Cross Section mm²
EMP.PLS.9ME010	400 V. AC 3N PE	5 X 4

Kod Code	Ürün Adı Description	Ebatlar Dimension mm			Ağırlık Weight kg	Net Net m³	Güç Power kw	Fiyatı Price Euro
		a	b	c				
EMP.PLS.9DE010	Patates Dinlendirme Chips Scuttle	400	900	300	25	0.11	0.65	615

Setüstü / Countertop

Kod Code	Elektrik Girişi Electric Input	Kablo Kesiti Cable Cross Section mm²
EMP.PLS.9DE010	230 V. AC N PE	3 X 1,5



2 mm üst tabla kalınlığı
2 mm top thickness



EMP.PLS.9DE010+EMP.PLS.9TS010

Türkçe

ELEKTRİKLİ MAKARNA HAŞLAMA

- Termostatik kontrol.
- Paslanmaz çelik sepetler.
- Su doldurma musluğu.
- Tahliye musluğu ile su boşaltma.
- Taşan su tahliye sistemi.
- Kolay temizlenebilir ve hijyeniktir.
- Paslanmaz çelik gövde.

PATATES DİNLENDİRME

- Kızartılmış patateslerin sıcak bekletilmesinde ve yağların süzülmesinde kullanılır.
- GN 1/1X150 mm küvet kapasitesi.
- Infrared seramik ısıtıcı.
- Havuzda kızartma yağının süzülmesi için maksimum verim sağlayan özel form.
- Kolay temizlenebilir ve hijyeniktir.
- Paslanmaz çelik gövde.

English

ELECTRIC PASTA COOKER

- Thermostatic control.
- Stainless steel baskets.
- Water filling tap.
- Discharge valve.
- Overflow drainage system.
- Easy to clean and hygienic.
- Stainless steel body.

CHIPS SCUTTLE

- Operates in order to keep fried food warm and drain oil.
- Capacity: GN 1/1X150 mm
- Ceramic infrared heater.
- Special form on the container, provides maximum efficiency in order to drain oil.
- Easy to clean and hygienic.
- Stainless steel body.

Gazlı Izgaralar
 Gas Grills

Kod Code	Ürün Adı Description	Ebatlar Dimension mm			Ağırlık Weight kg	Net Net m³	Güç Power kw	Fiyatı Price Euro
		a	b	c				
EMP.PLS.9IG010	Gazlı Izgara-Düz Gas Grill-Smooth	400	900	300	60	0.11	8.30	1.350

Setüstü / Countertop

Kod Code	Gaz Tüketim Değeri Gas Consumption Ng	Gaz Tüketim Değeri Gas Consumption Lpg
EMP.PLS.9IG010	0,87 m³/h	0,55 kg/h



Kod Code	Ürün Adı Description	Ebatlar Dimension mm			Ağırlık Weight kg	Net Net m³	Güç Power kw	Fiyatı Price Euro
		a	b	c				
EMP.PLS.9IG020	Gazlı Izgara-Düz Gas Grill-Smooth	800	900	300	100	0.22	16.60	2.090
EMP.PLS.9IG022	Gazlı Izgara-Düz+Oluklu Gas Grill-Smooth+Ribbed	800	900	300	105	0.22	16.60	2.215

Setüstü / Countertop



Kod Code	Gaz Tüketim Değeri Gas Consumption Ng	Gaz Tüketim Değeri Gas Consumption Lpg
EMP.PLS.9IG020	1,75 m³/h	1,11 kg/h
EMP.PLS.9IG022	1,75 m³/h	1,11 kg/h

Türkçe
GAZLI IZGARALAR

- Lpg ve Ng ile çalışabilme özelliği.
- Magnet emniyet ventilli ve pilotlu musluklar.
- Tam modüllerde iki bölgeyi ısıtma.
- Her brülör için piezzo çakmak ile kontrol.
- Çıkarılabilir yağ toplama haznesi
- Kolay temizlenebilir ve hijyeniktir.
- Paslanmaz çelik gövde.

English
GAS GRILLS

- Lpg or Natural Gas.
- Magnet safety gas valve and pilot flame.
- Two separate heating zones.
- Piezoelectric ignition system for each burner.
- Removable oil collecting drawer.
- Easy to clean and hygienic.
- Stainless steel body.

 2 mm üst tabla kalınlığı
 2 mm top thickness

Krom Tablalı
Chrome Plate

EMP.PLS.9IG020+EMP.PLS.9TS020

EMP.PLS.9IG010+EMP.PLS.9TS010

Elektrikli Izgaralar
Electric Grills



Kod Code	Ürün Adı Description	Ebatlar Dimension mm			Ağırlık Weight kg	Net Net m³	Güç Power kw	Fiyatı Price Euro
		a	b	c				
EMP.PLS.9IE010	Elektrikli Izgara-Düz Electric Grill-Smooth	400	900	300	60	0.11	6	1.445

Setüstü / Countertop

Kod Code	Elektrik Girişi Electric Input	Kablo Kesiti Cable Cross Section mm²
EMP.PLS.9IE010	400 V. AC 3N PE	5 X 2,5



Kod Code	Ürün Adı Description	Ebatlar Dimension mm			Ağırlık Weight kg	Net Net m³	Güç Power kw	Fiyatı Price Euro
		a	b	c				
EMP.PLS.9IE020	Elektrikli Izgara-Düz Electric Grill-Smooth	800	900	300	100	0.22	12	2.250
EMP.PLS.9IE022	Elektrikli Izgara- Düz+Oluklu Electric Grill- Smooth+Ribbed	800	900	300	105	0.22	12	2.355

Setüstü / Countertop

Kod Code	Elektrik Girişi Electric Input	Kablo Kesiti Cable Cross Section mm²
EMP.PLS.9IE020	400 V. AC 3N PE	5 X 4
EMP.PLS.9IE022	400 V. AC 3N PE	5 X 4



2 mm üst tabla kalınlığı
2 mm top thickness

Krom Tablalı
Chrome Plate



EMP.PLS.9IE020+EMP.PLS.9TS020 EMP.PLS.9IE010+EMP.PLS.9TS010

Türkçe

ELEKTRİKLİ IZGARALAR

- Termostatik kumanda.
- Tam modüllerde iki bölgeyi ısıtma.
- Çıkarılabilir yağ toplama haznesi.
- Kolay temizlenebilir ve hijyeniktir.
- Paslanmaz çelik gövde.

English

ELECTRIC GRILLS

- Thermostatic controller.
- Two separate heating zones.
- Removable oil collecting drawer.
- Easy to clean and hygienic.
- Stainless steel body.

Gazlı Lavataşlı Izgaralar
 Gas Lavastone Grills

Kod Code	Ürün Adı Description	Ebatlar Dimension mm			Ağırlık Weight kg	Net Net m³	Güç Power kw	Fiyatı Price Euro
		a	b	c				
EMP.PLS.9LG010	Lavataşlı Izgara - Gazlı Lavastone Grills - Gas	400	900	300	57	0.11	10.3	875

Setüstü / Countertop

Kod Code	Gaz Tüketim Değeri Gas Consumption Ng	Gaz Tüketim Değeri Gas Consumption Lpg
EMP.PLS.9LG010	1,09 m³/h	0,77 kg/h



Kod Code	Ürün Adı Description	Ebatlar Dimension mm			Ağırlık Weight kg	Net Net m³	Güç Power kw	Fiyatı Price Euro
		a	b	c				
EMP.PLS.9LG020	Lavataşlı Izgara - Gazlı Lavastone Grills - Gas	800	900	300	110	0.22	20.60	1.445

Setüstü / Countertop

Kod Code	Gaz Tüketim Değeri Gas Consumption Ng	Gaz Tüketim Değeri Gas Consumption Lpg
EMP.PLS.9LG020	2,18 m³/h	0,86 kg/h

Türkçe
GAZLI LAVATAŞLI IZGARALAR

- Lpg ve Ng ile çalışabilme özelliği.
- Magnet emniyet ventilli ve pilotlu musluklar.
- Tam modüllerde iki bölgeyi ısıtma.
- Her brülör için piezzo çakmak ile kontrol.
- Çıkarılabilir yağ toplama haznesi
- Kolay temizlenebilir ve hijyeniktir.
- Paslanmaz çelik gövde.

English
GAS LAVASTONE GRILLS

- Lpg or Ng.
- Magnet safety gas valve and pilot flame.
- Two separate heating zones.
- Piezoelectric ignition system for each burner.
- Removable oil collecting drawer.
- Easy to clean and hygienic.
- Stainless steel body.

2 mm üst tabla kalınlığı
2 mm top thickness
Döküm üst ızgara
Cast iron top

EMP.PLS.9LG020+EMP.PLS.9TS020



EMP.PLS.9LG010+EMP.PLS.9TS010

Gazlı Sulu Izgara
Gas Vapor Grill



Kod Code	Ürün Adı Description	Ebatlar Dimension mm			Ağırlık Weight kg	Net Net m³	Güç Power kw	Fiyatı Price Euro
		a	b	c				
EMP.PLS.9LG010-S	Gazlı Sulu Izgara Gas Vapor Grill	400	900	300	57	0.11	7	1.010

Setüstü / Countertop

Kod Code	Gaz Tüketim Değeri Gas Consumption Ng	Gaz Tüketim Değeri Gas Consumption Lpg
EMP.PLS.9LG010-S	0,75 m³/h	0,87 kg/h



Kod Code	Ürün Adı Description	Ebatlar Dimension mm			Ağırlık Weight kg	Net Net m³	Güç Power kw	Fiyatı Price Euro
		a	b	c				
EMP.PLS.9LG020-S	Gazlı Sulu Izgara Gas Vapor Grill	800	900	300	110	0.22	14	1.630

Setüstü / Countertop

Kod Code	Gaz Tüketim Değeri Gas Consumption Ng	Gaz Tüketim Değeri Gas Consumption Lpg
EMP.PLS.9LG020-S	1,50 m³/h	1,74 kg/h



Kod Code	Ürün Adı Description	Ebatlar Dimension mm			Ağırlık Weight kg	Net Net m³	Güç Power kw	Fiyatı Price Euro
		a	b	c				
EMP.PLS.9LG030-S	Gazlı Sulu Izgara Gas Vapor Grill	1200	900	300	135	0.32	21	2.330

Setüstü / Countertop

Kod Code	Gaz Tüketim Değeri Gas Consumption Ng	Gaz Tüketim Değeri Gas Consumption Lpg
EMP.PLS.9LG030-S	2,25 m³/h	2,61 kg/h

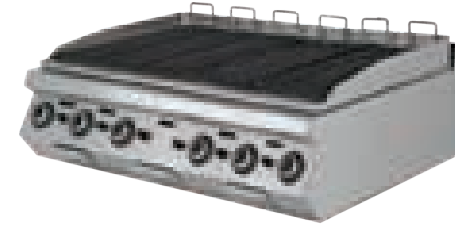

2 mm üst tabla kalınlığı
2 mm top thickness



EMP.PLS.9LG030-S+EMP.PLS.9TS030

Türkçe

GAZLI SULU IZGARA

- Buharlaştırma kabini sayesinde daha verimli pişirme.
- Lpg ve Ng ile çalışabilme özelliği.
- Magnet emniyet ventilli ve pilotlu musluklar.
- Tam modüllerde iki bölgeyi ısıtma.
- Her brülör için piezo çakmak ile kontrol.
- Pık döküm ızgara.
- Kolay temizlenebilir ve hijyeniktir.
- Paslanmaz çelik gövde.

English

GAS VAPOR GRILL

- Steamer cabinet provides fertile cooking.
- Lpg or Natural Gas.
- Magnet safety gas valve and pilot flame.
- Two seperate heating zones.
- Piezoelectric ignition system for each burner.
- Cast iron plate.
- Easy to clean and hygienic.
- Stainless steel body.

Elektrikli Benmariler
 Electric Bain maries

Kod Code	Ürün Adı Description	Ebatlar Dimension mm			Ağırlık Weight kg	Net Net m³	Güç Power kw	Fiyatı Price Euro
		a	b	c				
EMP.PLS.9SE010	Elektrikli Benmari Electric Bain marie	400	900	800	67	0.11	2.5	1.070

Dolaplı / With Cupboard

Kod Code	Elektrik Girişi Electric Input	Kablo Kesiti Cable Cross Section mm²
EMP.PLS.9SE010	230 V. AC N PE	3 X 1,5



Kod Code	Ürün Adı Description	Ebatlar Dimension mm			Ağırlık Weight kg	Net Net m³	Güç Power kw	Fiyatı Price Euro
		a	b	c				
EMP.PLS.9SE020	Elektrikli Benmari Electric Bain marie	800	900	800	120	0.22	4.4	1.765

Dolaplı / With Cupboard

Kod Code	Elektrik Girişi Electric Input	Kablo Kesiti Cable Cross Section mm²
EMP.PLS.9SE020	230 V. AC N PE	3 X 2,5

Türkçe
ELEKTRİKLİ BENMARİLER

- Termostatik kumanda.
- Yarım modülde 1 adet GN1/1.
- Tam modülde ise 2 adet GN1/1.
- Tahliye musluğu.
- Su alma musluğu.
- Kolay temizlenebilir ve hijyeniktir.
- Paslanmaz çelik gövde.

*Standart üretimimizde küvet bulunmamaktadır.

2 mm üst tabla kalınlığı
2 mm top thickness

English
ELECTRIC BAIN MARIES

- Thermostatic controller.
- Capacity of half modul; 1 piece of GN1/1.
- Capacity of full modul; 2 pieces of GN1/1.
- Drainage valve.
- Water inlet valve.
- Easy to clean and hygienic.
- Stainless steel body.

*Standart product does not have containers.

Ara Tezgahlar
Undercounter Worktop



Kod Code	Ürün Adı Description	Ebatlar Dimension mm			Ağırlık Weight kg	Net Net m³	Fiyatı Price Euro
		a	b	c			
EMP.PLS.9TN010	Ara Tezgah 1/2 Mod Worktop 1/2 Module	400	900	300	20	0.11	350

Setüstü / Countertop



Kod Code	Ürün Adı Description	Ebatlar Dimension mm			Ağırlık Weight kg	Net Net m³	Fiyatı Price Euro
		a	b	c			
EMP.PLS.9TN020	Ara Tezgah / 1 Mod Worktop 1 Module	800	900	300	37	0.22	600

Setüstü / Countertop

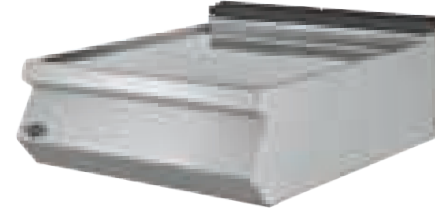

2 mm üst tabla kalınlığı
2 mm top thickness

Türkçe

ARA TEZGAHLAR

- Tezgahlar 60 seri cihazların altına kullanılabilecek uygun modüler ölçülerdedir.
- Kolay temizlenebilir ve hijyeniktir.
- Paslanmaz çelik gövde.

English

UNDERCOUNTER CABINET

- Under-Set Counters are suitable to use under each kind of 60's serie equipments.
- Easy to clean and hygienic.
- Stainless steel body.



EMP.PLS.9TN020+EMP.PLS.9TS020



EMP.PLS.9TN010+EMP.PLS.9TS010

Set Altı Dolaplar
Undercounter Cabinets



Kod Code	Ürün Adı Description	Ebatlar Dimension mm			Ağırlık Weight kg	Net Net m³	Fiyatı Price Euro
		a	b	c			
EMP.PLS.9TS010	Set Altı Tezgah Undercounter Cabinet	400x790x550			21	0.15	375



Kod Code	Ürün Adı Description	Ebatlar Dimension mm			Ağırlık Weight kg	Net Net m³	Fiyatı Price Euro
		a	b	c			
EMP.PLS.9TS020	Set Altı Tezgah Undercounter Cabinet	800x790x550			30	0.22	535



Kod Code	Ürün Adı Description	Ebatlar Dimension mm			Ağırlık Weight kg	Net Net m³	Fiyatı Price Euro
		a	b	c			
EMP.PLS.9TS030	Set Altı Tezgah Undercounter Cabinet	1200x790x550			38	0.33	890

Set Altı Fırınlar - Gazlı
Ovens - Gas



Kod Code	Ürün Adı Description	Ebatlar Dimension mm			Ağırlık Weight kg	Net Net m³	Güç Power kw	Fiyatı Price Euro
		a	b	c				
EMP.PLS.9FRG01	Set Altı Fırınlar - Gazlı Ovens - Gas	800	790	550	70	0.32	6.46	1.070



Kod Code	Ürün Adı Description	Ebatlar Dimension mm			Ağırlık Weight kg	Net Net m³	Güç Power kw	Fiyatı Price Euro
		a	b	c				
EMP.PLS.9FRG02	Set Altı Fırınlar - Gazlı Ovens - Gas	1200	790	550	90	0.52	6.46	1.335



Kod Code	Ürün Adı Description	Ebatlar Dimension mm			Ağırlık Weight kg	Net Net m³	Güç Power kw	Fiyatı Price Euro
		a	b	c				
EMP.PLS.9FRG03	Set Altı Maxi Fırınlar - Gazlı Maxi Ovens - Gas	1200	790	550	100	0.52	12.93	1.685



Türkçe

SET ALTI FIRINLAR - GAZLI

- Lpg ve Ng ile çalışabilme özelliği.
- 2xGN 2/1 tepsi kapasiteli paslanmaz çelik fırın iç haznesi.
- Termostatik ayarlı fırın gaz ventili.

English

OVENS - GAS

- Lpg or Natural Gas.
- 2xGN 2/1 capacity, stainless steel internal chamber.
- For oven temperature control with thermostatic gas valve.

Set Altı Fırınlar - Elektrikli
 Ovens - Electric

Kod Code	Ürün Adı Description	Ebatlar Dimension mm			Ağırlık Weight kg	Net Net m³	Güç Power kw	Fiyatı Price Euro
		a	b	c				
EMP.PLS.9FRE01	Set Altı Fırınlar - Elektrikli Ovens - Electric	800	790	550	70	0.32	9	1.070



Kod Code	Ürün Adı Description	Ebatlar Dimension mm			Ağırlık Weight kg	Net Net m³	Güç Power kw	Fiyatı Price Euro
		a	b	c				
EMP.PLS.9FRE02	Set Altı Fırınlar - Elektrikli Ovens - Electric	1200	790	550	90	0.52	9	1.335



Kod Code	Ürün Adı Description	Ebatlar Dimension mm			Ağırlık Weight kg	Net Net m³	Güç Power kw	Fiyatı Price Euro
		a	b	c				
EMP.PLS.9FRE03	Set Altı Maxi Fırınlar - Elektrikli Maxi Ovens - Electric	1200	790	550	100	0.52	15	1.685

Türkçe
SET ALTI FIRINLAR - ELEKTRİKLİ

- 2xGN 2/1 tepsi kapasiteli paslanmaz çelik fırın iç haznesi.

English
OVENS - ELECTRIC

- 2xGN 2/1 capacity, stainless steel internal chamber.

Devrilir Tavalar
Tilting Pans



Kod Code	Ürün Adı Description	Ebatlar Dimension mm			Ağırlık Weight kg	Net Net m³	Güç Power kw	Kapasite Capacity lt	Fiyatı Price Euro
		a	b	c					
EMP.PLS.DTG.80	Devrilir Tava (Gazlı) Tilting Pan (Gas)	800x900x850			145	0.62	11.20	80	3.460
EMP.PLS.DTE.80	Devrilir Tava (Elektrikli) Tilting Pan (Electrical)	800x900x850			138	0.62	12	80	3.460
EMP.PLS.DTG.120	Devrilir Tava (Gazlı) Tilting Pan (Gas)	1200x900x850			215	0.92	16.10	120	4.635
EMP.PLS.DTE.120	Devrilir Tava (Elektrikli) Tilting Pan (Electrical)	1200x900x850			208	0.92	12	120	4.635

Kod Code	Elektrik Girişi Electric Input v	Kablo Kesiti Cable Cross Section mm²
EMP. PLS. DTE.80	380	5x4
EMP. PLS. DTE.120	380	5x6

Kod Code	Gaz Tüketim Değeri Gas Consumption Ng	Gaz Tüketim Değeri Gas Consumption Lpg
EMP. PLS. DTG.80	1,18 m³/h	0,98 kg/h
EMP. PLS. DTG.120	1,70 m³/h	1,21 kg/h

Türkçe

DEVİRİLİR TAVALAR (GAZLI)

- Lpg ve Ng ile çalışabilme özelliği.
- Magnet emniyet ventilli termokulp ve termostat.
- Manuel kaldırma mekanizması.
- Karşı ağırlıklı kapak.
- Güvenlik sensörü.
- Kolay temizlenebilir ve hijyeniktir.
- Paslanmaz çelik gövde.

DEVİRİLİR TAVALAR (ELEKTRİKLİ)

- Manuel kaldırma mekanizması.
- Karşı ağırlıklı kapak.
- Güvenlik sensörü.
- Kolay temizlenebilir ve hijyeniktir.
- Paslanmaz çelik gövde.

English

TILTING PANS (GAS)

- Lpg or Natural Gas.
- Safety gas valve thermocouple and thermostat.
- Manuel lift system.
- Counterweighted hinged lid.
- Safety switch.
- Easy to clean and hygienic.
- Stainless steel body.

TILTING PANS (ELECTRICAL)

- Manuel lift system.
- Counterweighted hinged lid.
- Safety switch.
- Easy to clean and hygienic.
- Stainless steel body.

Kaynatma Tencereleri (İndirekt)
 Boiling Pans (Indirect)

Kod Code	Ürün Adı Description	Ebatlar Dimension mm			Ağırlık Weight kg	Net Net m³	Güç Power kw	Kapasite Capacity lt	Fiyatı Price Euro
		a	b	c					
EMP.PLS.KTG.150	Kaynatma Tenceresi (Gazlı) Boiling Pan (Gas)	800	900	850	155	0.62	16.10	150	5.170
EMP. PLS.KTE.150	Kaynatma Tenceresi (Elektrikli) Boiling Pan (Electrical)	800	900	850	100	0.62	18	150	5.170
EMP. PLS.KTG.250	Kaynatma Tenceresi (Gazlı) Boiling Pan (Gas)	1200	900	850	250	0.92	32.20	250	8.080
EMP. PLS.KTE.250	Kaynatma Tenceresi (Elektrikli) Boiling Pan (Electrical)	1200	900	850	190	0.92	30	250	8.080

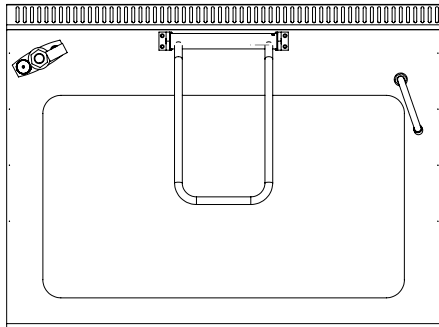

EMP.KTE.250 ve EMP.KTG.250 dikdörtgen modeldir.
 EMP.KTE.250 and EMP.KTG.250 are made rectangular type.

Kod Code	Elektrik Girişi Electric Input v	Kablo Kesiti Cable Cross Section mm²
EMP. PLS.KTE.150	380	5x6
EMP. PLS.KTE.250	380	5x10

Kod Code	Gaz Tüketim Değeri Gas Consumption Ng	Gaz Tüketim Değeri Gas Consumption Lpg
EMP. PLS.KTG.150	1,70 m³/h	1,21 kg/h
EMP. PLS.KTG.250	3,40 m³/h	2,42 kg/h

Türkçe
KAYNATMA TENCERELERİ (GAZLI)

- Lpg ve Ng ile çalışabilme özelliği.
- Magnet emniyet ventilli termokupl ve termostat.
- Aşırı basınç valfi ve manometre.
- Soğuk, sıcak su doldurma musluğu.
- Tahliye Musluğu.
- Karşı ağırlıklı kapak.
- Çift cidarlı ceket.
- Kolay temizlenebilir ve hijyeniktir.
- Paslanmaz çelik gövde.

KAYNATMA TENCERELERİ (ELEKTRİKLİ)

- Aşırı basınç valfi ve manometre.
- Soğuk, sıcak su doldurma musluğu.
- Tahliye Musluğu.
- Karşı ağırlıklı kapak.
- Çift cidarlı ceket.
- Kolay temizlenebilir ve hijyeniktir.
- Paslanmaz çelik gövde.

English
BOILING PANS (GAS)

- Lpg or Natural Gas.
- Safety gas valve thermocouple and thermostat.
- Over pressure safety valve and manometer.
- Cold, hot water inlet valve.
- Drainage valve.
- Counterweighted hinged lid.
- Double jacket pan.
- Easy to clean and hygienic.
- Stainless steel body.

BOILING PANS (ELECTRICAL)

- Over pressure safety valve and manometer.
- Cold, hot water inlet valve.
- Drainage valve.
- Counterweighted hinged lid.
- Double jacket pan.
- Easy to clean and hygienic.
- Stainless steel body.



Cantilever Hat
Cantilever Line



Tablo/Table



Kod Code	Ürün Adı Description	Ebatlar Dimension mm			Fiyatı Price Euro
		a	b	c	
EMP.PLS.9CTV240	Cantilever Hat Cantilever Line	2400	1710	550	3.880

Kod Code	Ürün Adı Description	Ebatlar Dimension mm			Fiyatı Price Euro
		a	b	c	
EMP.PLS.9CTV280	Cantilever Hat Cantilever Line	2800	1710	550	4.775

Kod Code	Ürün Adı Description	Ebatlar Dimension mm			Fiyatı Price Euro
		a	b	c	
EMP.PLS.9CTV320	Cantilever Hat Cantilever Line	3200	1710	550	5.170

Kod Code	Ürün Adı Description	Ebatlar Dimension mm			Fiyatı Price Euro
		a	b	c	
EMP.PLS.9CTV360	Cantilever Hat Cantilever Line	3600	1710	550	6.070

Kod Code	Ürün Adı Description	Ebatlar Dimension mm			Fiyatı Price Euro
		a	b	c	
EMP.PLS.9CTV400	Cantilever Hat Cantilever Line	4000	1710	550	6.475

Gazlı fritözler, Elektrikli fritözler, Elektrikli Benmariler, Elektrikli Makarna Haşlamalar ürünlerinde ALT KISIM dolaplı olarak gelmektedir.

For Gas Fryers , Electrical Fryers , Electrical Bainmaries and Electrical Pasta Cookers BOTTOM SIDE includes Cabinet.

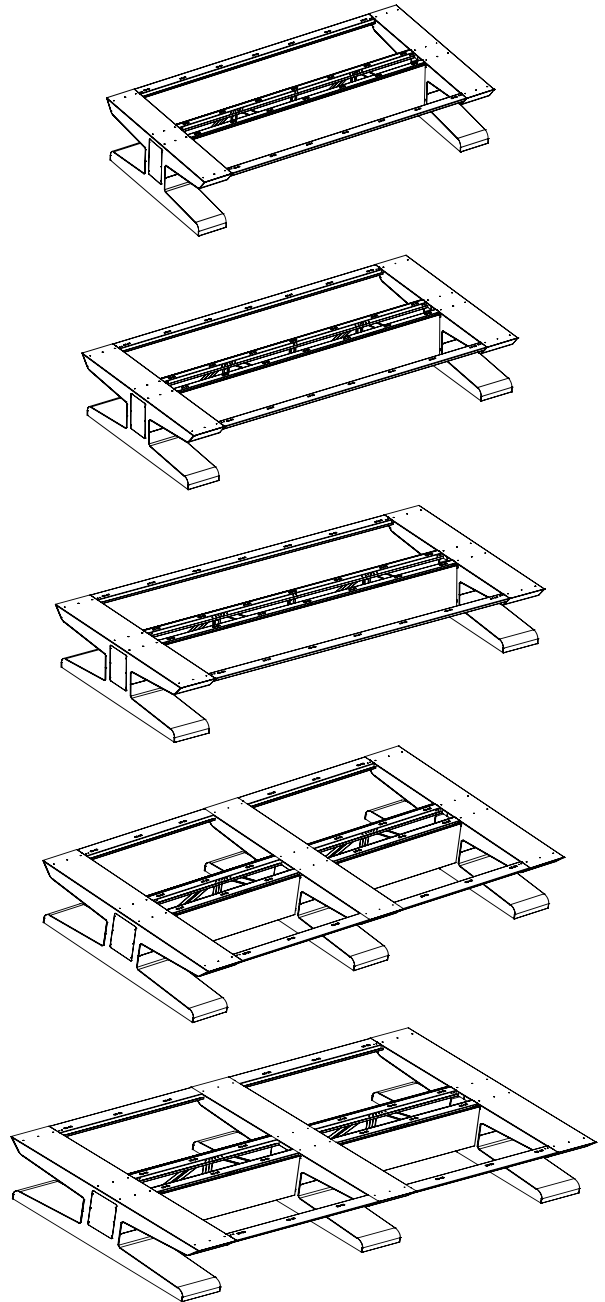

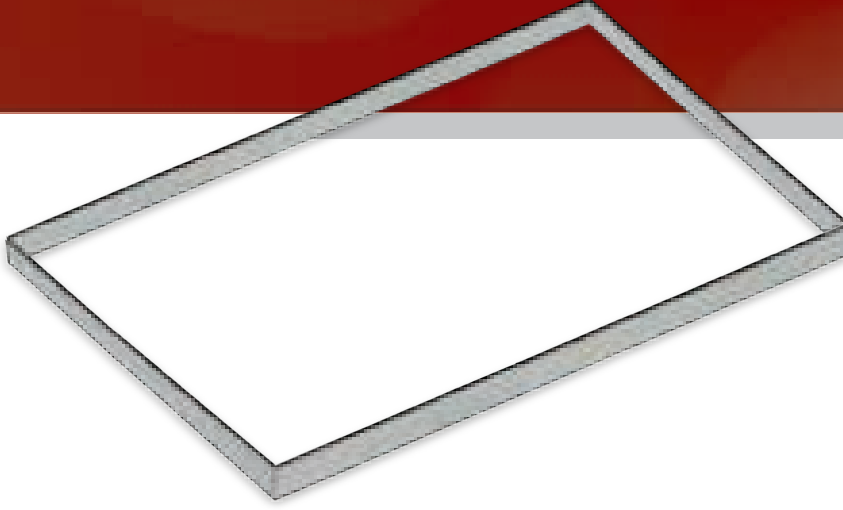
Paslanmaz Alt Bazalar
Stainless Steel Box Spring

Kod Code	Ürün Adı Description	Fiyatı Price Euro
EMP.PLS.9SBP240	Paslanmaz Alt Bazalar - 240 cm Stainless Steel Box Spring - 240 cm	620

Kod Code	Ürün Adı Description	Fiyatı Price Euro
EMP.PLS.9SBP280	Paslanmaz Alt Bazalar - 280 cm Stainless Steel Box Spring - 280 cm	740

Kod Code	Ürün Adı Description	Fiyatı Price Euro
EMP.PLS.9SBP320	Paslanmaz Alt Bazalar - 320 cm Stainless Steel Box Spring - 320 cm	845

Kod Code	Ürün Adı Description	Fiyatı Price Euro
EMP.PLS.9SBP360	Paslanmaz Alt Bazalar - 360 cm Stainless Steel Box Spring - 360 cm	965

Kod Code	Ürün Adı Description	Fiyatı Price Euro
EMP.PLS.9SBP400	Paslanmaz Alt Bazalar - 400 cm Stainless Steel Box Spring - 400 cm	1.070



Firunlar
Ovens



İş'in Mutfakı / Kitchen of Business

empero@empero.com.tr



Plus Fırınlar Plus Ovens

- * **Gazlı Döner Tabanlı Lavaş Makinesi / Rotating Bread Cooker - Gas**
- * **Tandır Fırını (Gazlı) / Gas Tandoori Oven**
- * **Profesyonel Kömürlü Fırın / Professional Charcoal Oven**
- * **Profesyonel Kömürlü Fırın / Professional Charcoal Oven**
- * **Asansörlü Kömürlü Izgara Ünitesi (Bask Tipi) / Lifted Charcoal Grill Unite (Busque Type)**
- * **Hibrid Profesyonel Barbekü Izgara / Hybrid Professional Barbeque Grill**
- * **Plus Konveksiyonlu Fırınlar (Gazlı) / Plus Convection Ovens (Gas)**
- * **Plus Konveksiyonlu Fırınlar (Gazlı) / Plus Convection Ovens (Gas)**
- * **Plus Konveksiyonlu Fırınlar (Elektrikli) / Plus Convection Ovens (Electric)**
- * **Plus Konveksiyonlu Fırınlar (Elektrikli) / Plus Convection Ovens (Electric)**

Tandır Fırını (Gazlı) - Döner Tabanlı Lavaş Makinesi (Gazlı)

Gas - Tandoori Oven - Rotating Bread Cooker - Gas



Gazlı Döner Tabanlı Lavaş Makinesi

Rotating Bread Cooker - Gas

Kod Code	Ürün Adı Description	Ebatlar Dimension mm			Ağırlık Weight kg	Net Net m³	Güç Power kw	Fiyatı Price Euro
		a	b	c				
EMP.RTD.01	Gazlı Döner Tabanlı Lavaş Makinesi Rotating Bread Cooker - Gas	1060	1100	955	220	1.11	12	8.000

Kod Code	Gaz Tüketim Değeri Gas Consumption Ng	Gaz Tüketim Değeri Gas Consumption Lpg
EMP.RTD.01	1,27 m3/h	0,94 kg/h

Türkçe

GAZLI DÖNER TABANLI LAVAS MAKİNESİ

- Ayarlanabilir üst tambur hızı.
- LPG veya NG ile çalışır.
- Musluklar Magnet Emniyet ventillidir.
- 90 cm çapında iç hazne ebatı.
- Saatte 500 lavaş pişirme kapasitesi.
- Dokunmatik kontrol panosu.
- Paslanmaz çelik gövde.

English

ROTATING BREAD COOKER - GAS

- Speed adjustable drum.
- Adaptable LPG or NG
- Magnet Safety valves.
- Cooking surface: 90 cm diameter.
- 500 bread production capacity per hour.
- Touch Control Screen.
- Stainless Steel Body.



Tandır Fırını (Gazlı)

Gas Tandoori Oven

Kod Code	Ürün Adı Description	Ebatlar Dimension mm			Ağırlık Weight kg	Net Net m³	Güç Power kw	Fiyatı Price Euro
		a	b	c				
EMP.TDR.01	Tandır Fırını - Gazlı Gas Tandoori Oven	715	945	1225	90	0.83	64.80	2.400

Kod Code	Gaz Tüketim Değeri Gas Consumption Ng	Gaz Tüketim Değeri Gas Consumption Lpg
EMP.TDR.01	6,85 m3/h	4,63 kg/h

Türkçe

TANDIR FIRINI (GAZLI)

- LPG veya NG ile çalışır.
- Musluklar Magnet Emniyet ventillidir.
- 66 cm iç hazne ebatı.
- İzolasyonlu gövde.
- Çıkarılabilir pislik tavası.
- Paslanmaz çelik gövde.

English

TANDOORI OVEN (GAS)

- Adaptable LPG or NG
- Magnet Safety valves.
- 66 cm dome dimension.
- Insulated body.
- Removable tray for waste collection.
- Stainless Steel Body.

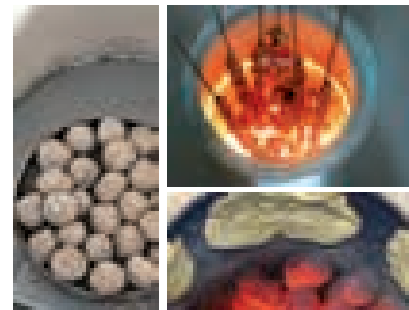

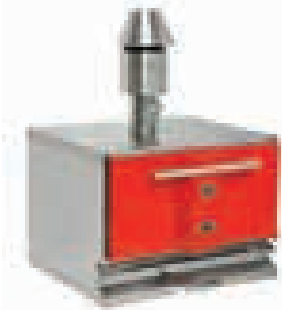
Profesyonel Kömürlü Fırın
Professional Charcoal Oven

Kod Code	Ürün Adı Description	Ebatlar Dimension mm			Ağırlık Weight kg	Net Net m³	Tel Izgara Grill Rack mm	Fiyatı Price Euro
		a	b	c				
EMP.PKF-40-K	Profesyonel Kömürlü Fırın-Kırmızı Professional Charcoal Oven- Red	710	730	666/1271	160	0.93	560x524	4.300



Kod Code	Ürün Adı Description	Ebatlar Dimension mm			Ağırlık Weight kg	Net Net m³	Tel Izgara Grill Rack mm	Fiyatı Price Euro
		a	b	c				
EMP.PKF-40-S	Profesyonel Kömürlü Fırın - Siyah Professional Charcoal Oven - Black	710	730	666/1271	160	0.93	560x524	4.300



Kod Code	Ürün Adı Description	Ebatlar Dimension mm			Ağırlık Weight kg	Net Net m³	Fiyatı Price Euro
		a	b	c			
EMP.PKF-40- US	Üst Dinlendirme Top Grill	704	725	X210	20	0.11	650

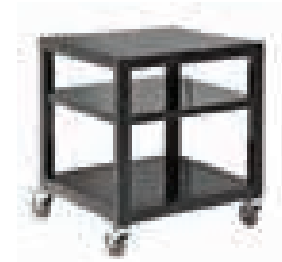

Kod Code	Ürün Adı Description	Ebatlar Dimension mm			Ağırlık Weight kg	Net Net m³	Fiyatı Price Euro
		a	b	c			
EMP.PKF-40-AS	Profesyonel Kömürlü Fırın - Alt Stand Professional Charcoal Oven- Bottom Stand	710	730	X825	20	0.42	500



Kod Code	Ürün Adı Description	Ebatlar Dimension mm			Ağırlık Weight kg	Net Net m³	Fiyatı Price Euro
		a	b	c			
EMP.PKF-40- D	Profesyonel Kömürlü Fırın - Alt Dolap Professional Charcoal Oven- Bottom Cabinet	710	730	X825	65	0.42	650

Türkçe
PROFESYONEL KÖMÜRLÜ FIRIN

- 500°C çalışma ısısı.
- 560x524 mm tel ızgara ebatı.
- Saatte 20 kg et kapasitesi.
- Kül çekmecesi.
- Standart davlumbaz.
- İzolasyonlu gövde.
- Paslanmaz çelik gövde.

English
PROFESSIONAL CHARCOAL OVEN

- 500°C working temperature.
- 560x524 mm grill rack size.
- 20 kg meat / h capacity.
- Ash drawer.
- Standard hood.
- Insulated body.
- Stainless Steel Body.

 EMP.PKF-40-K + EMP.PKF-40-D
+ EMP.PKF-40-US

Profesyonel Kömürlü Fırın
Professional Charcoal Oven



Kod Code	Ürün Adı Description	Ebatlar Dimension mm			Ağırlık Weight kg	Net Net m³	Tel Izgara Grill Rack mm	Fiyatı Price Euro
		a	b	c				
EMP.PKF-50- K	Profesyonel Kömürlü Fırın-Kırmızı Professional Charcoal Oven- Red	890X825X648/1271			190	0.93	740x650	5.800

Kod Code	Ürün Adı Description	Ebatlar Dimension mm			Ağırlık Weight kg	Net Net m³	Tel Izgara Grill Rack mm	Fiyatı Price Euro
		a	b	c				
EMP.PKF-50- S	Profesyonel Kömürlü Fırın - Siyah Professional Charcoal Oven - Black	890X825X648/1271			190	0.93	740x650	5.800

Kod Code	Ürün Adı Description	Ebatlar Dimension mm			Ağırlık Weight kg	Net Net m³	Fiyatı Price Euro
		a	b	c			
EMP.PKF-50- US	Üst Dinlendirme Top Grill	890x825x210			25	0.15	800

Kod Code	Ürün Adı Description	Ebatlar Dimension mm			Ağırlık Weight kg	Net Net m³	Fiyatı Price Euro
		a	b	c			
EMP.PKF-50- AS	Profesyonel Kömürlü Fırın - Alt Stand Professional Charcoal Oven- Bottom Stand	890x825x825			65	0.61	675

Kod Code	Ürün Adı Description	Ebatlar Dimension mm			Ağırlık Weight kg	Net Net m³	Fiyatı Price Euro
		a	b	c			
EMP.PKF-50- D	Profesyonel Kömürlü Fırın - Alt Dolap Professional Charcoal Oven- Bottom Cabinet	890x825x825			70	0.61	750



Türkçe

PROFESYONEL KÖMÜRLÜ FIRIN

- 500°C çalışma ısısı.
- 740x650 mm tel ızgara ebatı.
- Saatte 20 kg et kapasitesi.
- Kül çekmecesesi.
- Standart davlumbaz.
- İzolasyonlu gövde.
- Paslanmaz çelik gövde.

English

PROFESSIONAL CHARCOAL OVEN

- 500°C working temperature.
- 740x650 mm grill rack size.
- 20 kg meat / h capacity.
- Ash drawer.
- Standard hood.
- Insulated body.
- Stainless Steel Body.

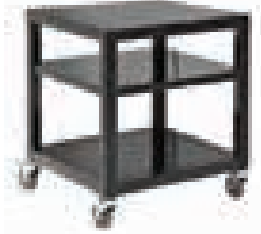
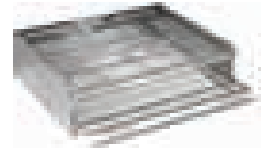

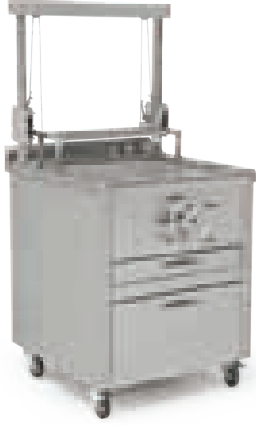
NEW**Fırınlar**
Ovens**Asansörlü Kömürlü Izgara Ünitesi (Bask Tipi)**
Lifted Charcoal Grill Unite (Busque Type)

Kod Code	Ürün Adı Description	Ebatlar Dimension mm			Ağırlık Weight kg	Net Net m³	Fiyatı Price Euro
		a	b	c			
EMP.BTG.01	Asansörlü Kömürlü Izgara Ünitesi Lifted Charcoal Grill Unite	800	746	1550	120	0.93	1.950



Kod Code	Ürün Adı Description	Ebatlar Dimension mm			Ağırlık Weight kg	Net Net m³	Fiyatı Price Euro
		a	b	c			
EMP.BTG.02	Asansörlü Kömürlü Izgara Ünitesi Lifted Charcoal Grill Unite	1200	746	1550	180	1.38	2.900



Kod Code	Ürün Adı Description	Ebatlar Dimension mm			Ağırlık Weight kg	Net Net m³	Fiyatı Price Euro
		a	b	c			
EMP.BTG.03	Asansörlü Kömürlü Izgara Ünitesi Lifted Charcoal Grill Unite	1600	746	1550	240	1.85	3.500

Türkçe**ASANSÖRLÜ KÖMÜRLÜ IZGARA ÜNİTESİ**

- EMP.BTG.01 için;
- 670x470 mm tel ızgara ebatı, 670x170 mm ebatında dinlendirme ızgarası
EMP.BTG.02 için;
- 1070x470 mm tel ızgara ebatı, 1070x170 mm ebatında dinlendirme ızgarası
EMP.BTG.03 için;
- 1470x470 mm tel ızgara ebatı, 1470x170 mm ebatında dinlendirme ızgarası
- Isıya dayanıklı paslanmaz çelik halatlar.
- Kül Haznesi.
- Kömür depolama dolabı.
- Hızlı ateşleme için hava kanalı.
- Paslanmaz çelik gövde.

English**LIFTED CHARCOAL GRILL UNITE**

- For EMP.BTG.01;
- 670x470 mm grill rack size, 670x170 mm over grill size.
For EMP.BTG.02;
- 1070x470 mm grill rack size, 1070x170 mm over grill size.
For EMP.BTG.03;
- 1470x470 mm grill rack size, 1470x170 mm over grill size.
- Heatproof stainless steel ropes.
- Ash drawer.
- Charcoal storage cabinet.
- Air flap.
- Stainless steel body.



Hibrid Profesyonel Barbekü Izgara
Hybrid Professional Barbeque Grill

Kod Code	Ürün Adı Description	Ebatlar Dimension mm			Ağırlık Weight kg	Net Net m³	Güç Power kw	Fiyatı Price Euro
		a	b	c				
EMP.PBK.01	Hibrid Profesyonel Barbekü Izgara Hybrid Professional Barbeque Grill	1045	775	1325	120	1.07	30	3.750

800x500 Pişirme Izgarası Ebatı

Kod Code	Gaz Tüketim Değeri Gas Consumption Ng	Gaz Tüketim Değeri Gas Consumption Lpg
EMP.PBK.01	3,1 m3/h	2,2 kg/h

Kod Code	Ürün Adı Description	Ebatlar Dimension mm			Ağırlık Weight kg	Net Net m³	Güç Power kw	Fiyatı Price Euro
		a	b	c				
EMP.PBK.02	Hibrid Profesyonel Barbekü Izgara Hybrid Professional Barbeque Grill	1345	775	1325	140	1.38	32+6	4.500

1000x500 Pişirme Izgarası Ebatı

Kod Code	Gaz Tüketim Değeri Gas Consumption Ng	Gaz Tüketim Değeri Gas Consumption Lpg
EMP.PBK.02	3,9 m3/h	2,9 kg/h

Kod Code	Ürün Adı Description	Ebatlar Dimension mm			Ağırlık Weight kg	Net Net m³	Güç Power kw	Fiyatı Price Euro
		a	b	c				
EMP.PBK010	Hibrid Barbekü Izgara Gazlı Ocağı Hybrid Barbeque Grill Cooker	500	810	880	50	0.35	13	900

Kod Code	Gaz Tüketim Değeri Gas Consumption Ng	Gaz Tüketim Değeri Gas Consumption Lpg
EMP.PBK.02	1,4 m3/h	1 kg/h



Türkçe

HİBRİD PROFESYONEL BARBEKÜ IZGARA

- LPG ve NG ile çalışmaya uygundur.
- EMP.PBK.01 için ızgara alan ebatı : 800x500
- EMP.PBK.02 için ızgara alan ebatı : 1000x500
- Katlanabilir çalışma tezgahı ebatı : 400x700
- 500c çalışma ısısı.
- Kömürlü kullanıma uygundur.
- Yatay döner şiş ve piliç çevirme aparatı fiyata dahildir.
- Paslanmaz çelik gövde.

English

HYBRID PROFESSIONAL BARBEQUE GRILL

- Adaptable to NG or LPG
- Grill dimension for EMP.PBK.01:800x500
- Grill dimension for EMP.PBK.02:1000x500
- Foldable working table surface dimension : 400x700
- 500c working temperature.
- Adaptable to operate with charcoal
- Skewer for horizontal shawarma meat and chicken is included in price.
- Stainless steel body.

Plus Konveksiyonlu Fırınlar (Gazlı)
Plus Convection Ovens (Gas)

Kod Code	Ürün Adı Description	Ebatlar Dimension mm			Ağırlık Weight kg	Net Net m³	Güç Power kw	Kapasite Capacity	Fiyatı Price Euro
		a	b	c					
EMP.GKF-10	Plus Konveksiyonlu Fırınlar-Gazlı Plus Convection Ovens-Gas	1040	1050	1160	120	1.24	35 Kw 380	10 GN-1/1	4.830
EMP. GKF-20	Plus Konveksiyonlu Fırınlar-Gazlı Plus Convection Ovens-Gas	1250	1150	1160	130	1.58	35 Kw 380	20 GN-1/1 / 10 GN-2/1	5.565
EMP.AS-10	EMP.PLS-G.10 Alt Stand EMP.PLS-G.10 Bottom Stand	1060	910	640	34	0.61			420
EMP.AS-20	EMP.PLS-G 20 Alt Stand EMP.PLS-G 20 Bottom Stand	1260	980	640	32	0.79			530

Kod Code	Gaz Tüketim Değeri Gas Consumption Ng	Gaz Tüketim Değeri Gas Consumption Lpg
EMP.GKF-10	3,70 m3/h	2,74 kg/h
EMP. GKF-20	3,70 m3/h	2,74 kg/h

Türkçe
PLUS KONVEKSİYONLU FIRINLAR (GAZLI)

- 7 inç renkli LCD ekran kontrol paneli.
- Aydınlatmalı dokunmatik buton.
- Çok adımlı pişirebilme özelliği.
- Harici bellek ile hafızaya yemek menüsü yükleyebilme özelliği.
- 99 çeşit program hafıza kapasitesi.
- Ekran üzerinden yemek ismi tanımlama özelliği.
- Manuel veya otomatik nemlendirme özelliği.
- Ekran üzerinden kullanım kılavuzuna ulaşabilme özelliği.
- Ayarlanabilir pişirme süresi ve dijital göstergesi.
- 0° C- 300° C arasında ayarlanabilir pişirme sıcaklığı ve dijital göstergesi.
- 360° C lik limit termostat.
- Paslanmaz çelik kapalı sistem ısı transfer boruları.
- Lpg ve Ng ile çalışabilme özelliği.
- Fırın içi temizlik duş sprey ünitesi.
- 2 hızlı paslanmaz çelik fan.
- Çift yöne dönebilen fan ile eşit ısı dağılımı.
- Silikon contalı temperlenmiş cam.
- Kolay temizlik imkanı sağlayan açılabilir iç cam.
- Sensörlü kapı sistemi.
- Paslanmaz çelik gövde.

English
PLUS CONVECTION OVENS (GAS)

- 7 inch touch screen LCD control panel.
- Illustrated food menu upload option through external memory.
- 99 different kind of programme upload options.
- Food name defining option through touch screen.
- Manual and periodic steamer.
- User manuel accessibility through touch screen.
- Adjustable cooking time.
- Adjustable cooking temperature between 0° C- 300° C
- Safety thermostat for overheating protection (360° C).
- Stainless steel heat exchanger sealed system pipes.
- Lpg or Natural Gas.
- Retractable shower.
- 2 speed stainless steel fan.
- Dual direction fan provides homogenous heat distribution.
- Silicone sealed tempered glass.
- Easy-access interior glass in order to provide cleanning.
- Door switch system.
- Stainless steel body.

Tüm modellerde tepsi kitleri fiyata dahildir.

Tray kits are included in the price for each model.



Su geçirmez touch kontrol paneli
Water proof touch panel control

Plus Konveksiyonlu Fırınlar (Gazlı)
Plus Convection Ovens (Gas)



Kod Code	Ürün Adı Description	Ebatlar Dimension mm			Ağırlık Weight kg	Net Net m³	Güç Power kw	Kapasite Capacity	Fiyatı Price Euro
		a	b	c					
EMP.GKF.40	Plus Konveksiyonlu Fırınlar-Gazlı Plus Convection Ovens-Gas	1250	1150	1900	250	2.63	46.5 Kw 380 V	40 GN-1/1 / 20 GN-2/1	8.085
EMP.TA.12-40X60	Patisserie Tepsi Taşıma Arabası ve Tepsi Kiti Patisserie Tray Carrying Trolley and Tray Kit	670	911	1746	60	1.06		12x(40x60)	900
EMP.TA.12.Y	Tepsi Taşıma Arabası ve Tepsi Kiti Tray Carrying Trolley and Tray Kit	670	911	1746	60	1.06		24 GN-1/1 / 12 GN-2/1	900
EMP.TA.16.Y	Tepsi Taşıma Arabası ve Tepsi Kiti Tray Carrying Trolley and Tray Kit	670	911	1746	60	1.06		32 GN-1/1 / 16 GN-2/1	900
EMP.TA.20.Y	Tepsi Taşıma Arabası ve Tepsi Kiti Tray Carrying Trolley and Tray Kit	670	911	1746	60	1.06		40 GN-1/1 / 20 GN-2/1	900

Kod Code	Gaz Tüketim Değeri Gas Consumption Ng	Gaz Tüketim Değeri Gas Consumption Lpg
EMP.GKF.40	4,92 m³/h	3,65 kg/h

Türkçe

PLUS KONVEKSİYONLU FIRINLAR (GAZLI)

- 7 inç renkli LCD ekran kontrol paneli.
- Aydınlatmalı dokunmatik buton.
- Çok adımlı pişirebilme özelliği.
- Harici bellek ile hafızaya yemek menüsü yükleyebilme özelliği.
- 99 çeşit program hafıza kapasitesi.
- Ekran üzerinden yemek ismi tanımlama özelliği.
- Manuel veya otomatik nemlendirme özelliği.
- Ekran üzerinden kullanım kılavuzuna ulaşabilme özelliği.
- Ayarlanabilir pişirme süresi ve dijital göstergesi.
- 0° C- 300° C arasında ayarlanabilir pişirme sıcaklığı ve dijital göstergesi.
- 360° C lik limit termostat.
- Paslanmaz çelik kapalı sistem ısı transfer boruları.
- Lpg ve Ng ile çalışabilme özelliği.
- Fırın içi temizlik duş sprey ünitesi.
- 2 hızlı paslanmaz çelik fan.
- Çift yöne dönebilen fan ile eşit ısı dağılımı.
- Silikon contalı temperlenmiş cam.
- Kolay temizlik imkanı sağlayan açılabilir iç cam.
- Sensörlü kapı sistemi.
- Paslanmaz çelik gövde.

English

PLUS CONVECTION OVENS (GAS)

- 7 inch touch screen LCD control panel.
- Illustrated food menu upload option through external memory.
- 99 different kind of programme upload options.
- Food name defining option through touch screen.
- Manual and periodic steamer.
- User manuel accessibility through touch screen.
- Adjustable cooking time.
- Adjustable cooking temperature between 0° C- 300° C
- Safety thermostat for overheating protection (360° C).
- Stainless steel heat exchanger sealed system pipes.
- Lpg or Natural Gas.
- Retractable shower.
- 2 speed stainless steel fan.
- Dual direction fan provides homogenous heat distribution.
- Silicone sealed tempered glass.
- Easy-access interior glass in order to provide cleanning.
- Door switch system.
- Stainless steel body.

- Unlu mamüller pişirmek için EMP.TA.12-40x60 tepsi taşıma arabasını ve tepsi kitini kullanınız.

- Please use EMP.TA.12-40X60 patisserie tray carrying trolley and tray kit in purpose of cooking bakery products

- Bir adet 40GN-1/1 tepsi taşıma arabasına tepsi kiti fiyata dahildir.

- One piece of 40GN-1/1 tray carrying trolley and tray kit is included in the price



Su geçirmez touch kontrol paneli
Water proof touch panel control



EMP.TA-20.Y

Plus Konveksiyonlu Fırınlar (Elektrikli)
Plus Convection Ovens (Electric)

EMP.EKF-6
Konveksiyonlu Fırın - Elektrikli
Convection Oven - Electrical

Kod Code	Ürün Adı Description	Ebatlar Dimension mm			Ağırlık Weight kg	Net Net m ³	Güç Power kw	Kapasite Capacity	Fiyatı Price Euro
		a	b	c					
EMP.EKF-6	Konveksiyonlu Fırın - Elektrikli Convection Oven - Electrical	800	855	700	85	0.47	10 Kw - 380 V	6 GN-1/1	2.200
EMP.EKF-10	Plus Konveksiyonlu Fırınlar - Elektrikli Plus Convection Ovens - Electrical	1040	1050	1160	135	1.22	16,5 Kw 380V 3-50 Hz	10 GN-1/1	4.850
EMP.EKF-20	Plus Konveksiyonlu Fırınlar - Elektrikli Plus Convection Ovens - Electrical	1250	1150	1160	130	1.55	24 Kw 380V 3-50 Hz	20 GN-1/1 / 10 GN-2/1	5.575
EMP.AS-10	EMP.PLS-E.10 Alt Stand EMP.PLS-E.10 Bottom Stand	1060	910	640	28	0.61			420
EMP.AS-20	EMP.PLS-E 20 Alt Stand EMP.PLS-E 20 Bottom Stand	1255	980	640	32	0.79			530
EMP.ASK-6	EMP.EKF-6 Alt Stand EMP.EKF-6 Bottom Stand	865	815	850	24	0.60			320

Türkçe
PLUS KONVEKSİYONLU FIRINLAR (ELEKTRİKLİ)

- 7 inç renkli LCD ekran kontrol paneli.
- Aydınlatmalı dokunmatik buton.
- Çok adımlı pişirebilme özelliği.
- Harici bellek ile hafızaya yemek menüsü yükleyebilme özelliği.
- 99 çeşit program hafıza kapasitesi.
- Ekran üzerinden yemek ismi tanımlama özelliği.
- Manuel veya otomatik nemlendirme özelliği.
- Ekran üzerinden kullanım kılavuzuna ulaşabilme özelliği.
- Ayarlanabilir pişirme süresi ve dijital göstergesi.
- 0° C- 300° C arasında ayarlanabilir pişirme sıcaklığı ve dijital göstergesi.
- 360° C lik limit termostat.
- PID sistemiyle hassas ısı kontrolü. (SSR röleli)
- Fırın içi temizlik duş sprey ünitesi.
- 2 hızlı paslanmaz çelik fan.
- Çift yöne dönebilen fan ile eşit ısı dağılımı.
- Silikon contalı temperlenmiş cam.
- Kolay temizlik imkanı sağlayan açılabilir iç cam.
- Sensörlü kapı sistemi.
- Paslanmaz çelik gövde.

EMP.EKF-6

- 2.4 inç renkli LCD ekran kontrol paneli.
- Aydınlatmalı dokunmatik buton.
- 99 çeşit program hafıza kapasitesi.
- Çift yöne dönebilen fan ile eşit ısı dağılımı.
- Manuel buhar verme.
- Silikon contalı temperlenmiş cam.
- Sensörlü kapı sistemi.
- Paslanmaz çelik gövde.

English
PLUS CONVECTION OVENS (ELECTRIC)

- 7 inch touch screen LCD control panel.
- Illustrated food menu upload option through external memory.
- 99 different kind of programme upload options.
- Food name defining option through touch screen.
- Manual and periodic steamer.
- User manuel accessibility through touch screen.
- Adjustable cooking time.
- Adjustable cooking temperature between 0° C- 300° C
- Safety thermostat for overheating protection (360° C).
- PID system provide sensitive heating (SSR relay)
- Retractable shower.
- 2 speed stainless steel fan.
- Dual direction fan provides homogenous heat distribution.
- Silicone sealed tempered glass.
- Easy-access interior glass in order to provide cleanning.
- Door switch system.
- Stainless steel body.

EMP.EKF-6

- 2.4 inch touch screen LCD control panel.
- Illustrated food menu upload option through external memory.
- 99 different kind of programme upload options.
- Dual direction fan provides homogenous heat distribution.
- Manuel steamer.
- Silicone sealed tempered glass.
- Switch system on the door.
- Stainless steel body.

Kod Code	Elektrik Girişi Electric Input V	Kablo Kesiti Cable Cross Section mm ²
EMP.EKF-10	380	5x6
EMP.EKF-20	380	5x6
EMP.EKF-6	380	5x2.5

**Tüm modellerde tepsi kitleri
fiyata dahildir.
Tray kits are included in the
price for each model.**



**Su geçirmez touch kontrol paneli
Water proof touch panel control**

Plus Konveksiyonlu Fırınlar (Elektrikli)
Plus Convection Ovens (Electric)



Kod Code	Ürün Adı Description	Ebatlar Dimension mm			Ağırlık Weight kg	Net Net m³	Güç Power kw	Kapasite Capacity	Fiyatı Price Euro
		a	b	c					
EMP.EKF-40	Plus Konveksiyonlu Fırınlar - Elektrikli Plus Convection Ovens - Electrical	1250x1150x1900			250	2.58	47,5 Kw 380V 3-50 Hz	40 GN-1/1 / 20 GN-2/1	8.300
EMP.TA.12- 40X60	Patisserie Tepsi Taşıma Arabası ve Tepsi Kiti Patisserie Tray Carrying Trolley and Tray Kit	670x911x1746			60	1.06		12x(40x60)	900
EMP.TA-12.Y	Tepsi Taşıma Arabası ve Tepsi Kiti Tray Carrying Trolley and Tray Kit	670x911x1746			60	1.06		24 GN-1/1 / 12 GN-2/1	900
EMP.TA-16.Y	Tepsi Taşıma Arabası ve Tepsi Kiti Tray Carrying Trolley and Tray Kit	670x911x1746			60	1.06		32 GN-1/1 / 16 GN-2/1	900
EMP.TA-20.Y	Tepsi Taşıma Arabası ve Tepsi Kiti Tray Carrying Trolley and Tray Kit	670x911x1746			60	1.06		40 GN-1/1 / 20 GN-2/1	900

Kod Code	Elektrik Girişi Electric Input V	Kablo Kesiti Cable Cross Section mm²
EMP.EKF-40	380	5x10

- Unlu mamüller pişirmek için EMP.TA.12-40x60 tepsi taşıma arabasını ve tepsi kitini kullanınız.

- Please use EMP.TA.12-40X60 patisserie tray carrying trolley and tray kit in purpose of cooking bakery products

- Bir adet 40GN-1/1 tepsi taşıma arabası ve tepsi kiti fiyata dahildir.

- One piece of 40GN-1/1 tray carrying trolley and tray kit is included in the price



Su geçirmez touch kontrol paneli
Water proof touch panel control

Türkçe

PLUS KONVEKSİYONLU FIRINLAR (ELEKTRİKLİ)

- 7 inç renkli LCD ekran kontrol paneli.
- Aydınlatmalı dokunmatik buton.
- Çok adımlı pişirebilme özelliği.
- Harici bellek ile hafızaya yemek menüsü yükleyebilme özelliği.
- 99 çeşit program hafıza kapasitesi.
- Ekran üzerinden yemek ismi tanımlama özelliği.
- Manuel veya otomatik nemlendirme özelliği.
- Ekran üzerinden kullanım kılavuzuna ulaşabilme özelliği.
- Ayarlanabilir pişirme süresi ve dijital göstergesi.
- 0° C- 300° C arasında ayarlanabilir pişirme sıcaklığı ve dijital göstergesi.
- 360° C lik limit termostat.
- PID sistemiyle hassas ısı kontrolü. (SSR rölesi)
- Fırın içi temizlik duş sprey ünitesi.
- 2 hızlı paslanmaz çelik fan.
- Çift yöne dönebilen fan ile eşit ısı dağılımı.
- Silikon contalı temperlenmiş cam.
- Kolay temizlik imkanı sağlayan açılabilir iç cam.
- Sensörlü kapı sistemi.
- Paslanmaz çelik gövde.

English

PLUS CONVECTION OVENS (ELECTRIC)

- 7 inch touch screen LCD control panel.
- Illustrated food menu upload option through external memory.
- 99 different kind of programme upload options.
- Food name defining option through touch screen.
- Manual and periodic steamer.
- User manual accessibility through touch screen.
- Adjustable cooking time.
- Adjustable cooking temperature between 0° C- 300° C
- Safety thermostat for overheating protection (360° C).
- PID system provide sensitive heating (SSR relay)
- Retractable shower.
- 2 speed stainless steel fan.
- Dual direction fan provides homogenous heat distribution.
- Silicone sealed tempered glass.
- Easy-access interior glass in order to provide cleaning.
- Door switch system.
- Stainless steel body.



EMP.TA-20.Y



supported by ANGELO PO

İthal Kombi Fırınlar Imported Combi Ovens

- * Gazlı Kombi Fırınlar / Gas Combi Ovens
- * Gazlı Kombi Fırınlar / Gas Combi Ovens
- * Elektrikli Kombi Fırınlar / Electric Combi Ovens
- * Elektrikli Kombi Fırınlar / Electric Combi Ovens
- * Şok Dondurucu / Blast Freezer / Chiller
- * Şok Dondurucu / Blast Freezer / Chiller

Gazlı Kombi Fırınlar
Gas Combi Ovens



Kod Code	Ürün Adı Description	Ebatlar Dimension mm			Ağırlık Weight kg	Net Net m³	Güç Power kw	Yükleme Kapasite Loading Capacity porsiyon	Fiyatı Price Euro
		a	b	c					
EMPCBG6	Gazlı Kombi Fırınlar 6 Gn 1/1 Gas Combi Oven 6 Gn 1/1	920	874	730	185	1	13.5	85	9.800
EMPCBG6-AS	Alt Stand 6 Gn 1/1 Bottom Stand 6 Gn 1/1	740	850	700	25	0.45			320



Kod Code	Ürün Adı Description	Ebatlar Dimension mm			Ağırlık Weight kg	Net Net m³	Güç Power kw	Yükleme Kapasite Loading Capacity porsiyon	Fiyatı Price Euro
		a	b	c					
EMPCBG10	Gazlı Kombi Fırınlar 10 Gn 1/1 Gas Combi Oven 10 Gn 1/1	920	874	975	213	1.2	19.5	140	10.975
EMPCBG10-AS	Alt Stand 10 Gn 1/1 Bottom Stand 10 Gn 1/1	700	860	600	30	0.3			420



Tütsüleme Kiti
Smoking Kit

Kod Code	Ürün Adı Description	Ebatlar Dimension mm			Ağırlık Weight kg	Net Net m³	Güç Power kw	Fiyatı Price Euro
		a	b	c				
EMPTTK01	Tütsüleme Kiti Smoking Kit	230	355	120	5.2	0.01	0.15	1.200



Türkçe

GAZLI KOMBİ FIRINLAR

- 230 V. 50 Hz çalışma gücü.
- LPG ve NG ile çalışabilme özelliği.
- Pişirme sırasında enerji sarfiyatını düşüren ECO fonksiyonu.
- PLUS ekstra güç fonksiyonu (gaz).
- SC2 yarı otomatik yıkama.
- 99 programlı pişirme hafızası : 4 fazlı; 3 ısıtma, 4 düşük dereceli pişirme ve 1 delta T programı.
- Tek noktalı pişirme probu.
- UR2 pişirme esnasında otomatik nem kontrolü.
- RDC ekonomik buhar jenerasyonu sistemi.
- Ters yönlü 2 kademeli AWC fan.
- Dijital kontrol.
- Manuel buhar enjeksiyonu.
- Alarmla uyarı verebilen arıza teşhis özelliği.
- IPX5 koruma derecesi.
- Çift temperli camlı kapı.
- 304 kalite paslanmaz dış gövde, 316 kalite fırın iç yapısı.
- Ergonomik kapı kulbu.
- Kapalı kapı ile fırın içi soğutma fonksiyonu.
- Pişirme başlangıç saatini ayarlayabilme özelliği.
- Set edilen ve ölçülen sıcaklık değerlerini ayrı ayrı gösterebilme özelliği.
- Düşük sıcaklıklı veya yüksek sıcaklıklı buhar üretebilme özelliği.
- Kendi kendini yıkayabilme özelliği.

English

GAS COMBI OVENS

- 230 V. 50 Hz operation power.
- Lpg or Natural Gas.
- ECO function for consumption reduction in cooking.
- PLUS extra power function (gas).
- SC2 semi automatic washing.
- Cooking modes: manual or programmable selection, 99 programs with 4 phases of whom 7 are standard, 3 re-heating programs, 5 smoking, 4 Low Temperature and 1 Delta T.
- Single-point temperature core probe.
- UR2 automatic humidity control while cooking.
- RDC steam generator with low management cost.
- Automatic fan reverse AWC, 2 fan speeds.
- Digital controls.
- Manual steam injection.
- Self-diagnosis with malfunction alarms.
- IPX5 protection degree.
- Door double tempered glazing.
- AISI 304 stainless steel polished cooking chamber ,with AISI 316L (1,2 mm) top and bottom and rounded edges without joints.
- Handle with double handgrip, easier opening also with hands full.
- Automatic Cooling and Preheating.
- Start-up time selection.
- Display of set and current cooking values.
- Low temperature steam and Superheated steam.
- Self cleaning system.

Tüm modellerde tepsi kitleri
fiyatlara dahildir.
Tray kits are included in the price
for each model.

Gazlı Kombi Fırınlar
Gas Combi Ovens

Kod Code	Ürün Adı Description	Ebatlar Dimension mm			Ağırlık Weight kg	Net Net m³	Güç Power kw	Yükleme Kapasite Loading Capacity porsiyon	Fiyatı Price Euro
		a	b	c					
EMPCBG24	Gazlı Kombi Fırınlar 12 Gn 2/1 Gas Combi Oven 12 Gn 2/1	1178	1064	1190	283	2.9	32	335	13.850
EMPCBG24-AS	Alt Stand 12 Gn 2/1 Bottom Stand 12 Gn 2/1	1210	860	600	32	0.6			530



Kod Code	Ürün Adı Description	Ebatlar Dimension mm			Ağırlık Weight kg	Net Net m³	Güç Power kw	Yükleme Kapasite Loading Capacity porsiyon	Fiyatı Price Euro
		a	b	c					
EMPCBG40	Gazlı Kombi Fırınlar 40 Gn 1/1 Gas Combi Oven 40 Gn 1/1	1190	1074	1795	449	3.4	55	560	26.180
EMPCBG40-TA-16	Tepsi Taşıma Arabası ve Tepsi Kiti Tray Carrying Trolley and Tray Kit	590	750	1700	77	1.5		15 40x60	2.350
EMPCBG40-TA-20	Tepsi Taşıma Arabası ve Tepsi Kiti Tray Carrying Trolley and Tray Kit	820	920	1710	77	1.5		20 GN-2/1	2.450

Tütsüleme Kiti
Smoking Kit

Kod Code	Ürün Adı Description	Ebatlar Dimension mm			Ağırlık Weight kg	Net Net m³	Güç Power kw	Fiyatı Price Euro
		a	b	c				
EMPTTK01	Tütsüleme Kiti Smoking Kit	230	355	120	5.2	0.01	0.15	1.200

Türkçe
GAZLI KOMBİ FIRINLAR

- 230 V. 50 Hz çalışma gücü.
- LPG ve NG ile çalışabilme özelliği.
- Pişirme sırasında enerji sarfiyatını düşüren ECO fonksiyonu.
- PLUS ekstra güç fonksiyonu (gaz).
- SC2 yarı otomatik yıkama.
- 99 programlı pişirme hafızası : 4 fazlı; 3 ısıtma, 4 düşük dereceli pişirme ve 1 delta T programı.
- Tek noktalı pişirme probu.
- UR2 pişirme esnasında otomatik nem kontrolü.
- RDC ekonomik buhar jenerasyonu sistemi.
- Ters yönlü 2 kademeli AWC fan.
- Dijital kontrol.
- Manuel buhar enjeksiyonu.
- Alarmla uyarı verebilen arıza teşhis özelliği.
- IPX5 koruma derecesi.
- Çift temperli camlı kapı.
- 304 kalite paslanmaz dış gövde, 316 kalite fırın iç yapısı.
- Ergonomik kapı kulbu.
- Kapalı kapı ile fırın içi soğutma fonksiyonu.
- Pişirme başlangıç saatini ayarlayabilme özelliği.
- Set edilen ve ölçülen sıcaklık değerlerini ayrı ayrı gösterebilme özelliği.
- Düşük sıcaklıklı veya yüksek sıcaklıklı buhar üretebilme özelliği.
- Kendi kendini yıkayabilme özelliği.

English
GAS COMBI OVENS

- 230 V. 50 Hz operation power.
- Lpg or Natural Gas.
- ECO function for consumption reduction in cooking.
- PLUS extra power function (gas).
- SC2 semi automatic washing.
- Cooking modes: manual or programmable selection, 99 programs with 4 phases of whom 7 are standard, 3 re-heating programs, 5 smoking, 4 Low Temperature and 1 Delta T.
- Single-point temperature core probe.
- UR2 automatic humidity control while cooking.
- RDC steam generator with low management cost.
- Automatic fan reverse AWC, 2 fan speeds.
- Digital controls.
- Manual steam injection.
- Self-diagnosis with malfunction alarms.
- IPX5 protection degree.
- Door double tempered glazing.
- AISI 304 stainless steel polished cooking chamber ,with AISI 316L (1,2 mm) top and bottom and rounded edges without joints.
- Handle with double handgrip, easier opening also with hands full.
- Automatic Cooling and Preheating.
- Start-up time selection.
- Display of set and current cooking values.
- Low temperature steam and Superheated steam.
- Self cleaning system.

Tüm modellerde tepsi kitleri fiyatlara dahildir. Tray kits are included in the price for each model.

- Bir adet 40GN-1/1 tepsi taşıma arabasıve tepsi kiti fiyata dahildir.

- One piece of 40GN-1/1 tray carrying trolley and tray kit is included in the price

Elektrikli Kombi Fırınlar
Electric Combi Ovens

Kod Code	Ürün Adı Description	Ebatlar Dimension mm			Ağırlık Weight kg	Net Net m³	Güç Power kw	Yükleme Kapasite Loading Capacity porsiyon	Fiyatı Price Euro
		a	b	c					
EMPCBE6	Elektrikli Kombi Fırınlar 6 Gn 1/1 Electric Combi Oven 6 Gn 1/1	920	874	730	160	1	10.1	85	8.300
EMPCBE6-AS	Alt Stand 6 Gn 1/1 Bottom Stand 6 Gn 1/1	740	850	700	25	0.45			320



Kod Code	Ürün Adı Description	Ebatlar Dimension mm			Ağırlık Weight kg	Net Net m³	Güç Power kw	Yükleme Kapasite Loading Capacity porsiyon	Fiyatı Price Euro
		a	b	c					
EMPCBE10	Elektrikli Kombi Fırınlar 10 Gn 1/1 Electric Combi Oven 10 Gn 1/1	920	874	975	198	1.2	17.3	140	9.570
EMPCBE10-AS	Alt Stand 10 Gn 1/1 Bottom Stand 10 Gn 1/1	700	860	600	30	0.3			420

Tütsüleme Kiti
Smoking Kit

Kod Code	Ürün Adı Description	Ebatlar Dimension mm			Ağırlık Weight kg	Net Net m³	Güç Power kw	Fiyatı Price Euro
		a	b	c				
EMPTTK01	Tütsüleme Kiti Smoking Kit	230	355	120	5.2	0.01	0.15	1.200



**Tüm modellerde tepsi kitleri
fiyatlara dahildir.
Tray kits are included in the price
for each model.**

Türkçe

ELEKTRİKLİ KOMBİ FIRINLAR

- 400 V. 50 Hz çalışma gücü.
- Pişirme sırasında enerji sarfiyatını düşüren ECO fonksiyonu.
- SC2 yarı otomatik yıkama.
- 99 programlı pişirme hafızası : 4 fazlı; 3 ısıtma, 4 düşük dereceli pişirme ve 1 delta T programı.
- Tek noktalı pişirme probu.
- UR2 pişirme esnasında otomatik nem kontrolü.
- RDC ekonomik buhar jenerasyonu sistemi.
- Ters yönlü 2 kademeli AWC fan.
- Dijital kontrol.
- Manuel buhar enjeksiyonu.
- Alarmla uyarı verebilen arıza teşhis özelliği.
- IPX5 koruma derecesi.
- Çift temperli camlı kapı.
- 304 kalite paslanmaz dış gövde, 316 kalite fırın iç yapısı.
- Ergonomik kapı kulbu.
- Kapalı kapı ile fırın içi soğutma fonksiyonu.
- Pişirme başlangıç saatini ayarlayabilme özelliği.
- Set edilen ve ölçülen sıcaklık değerlerini ayrı ayrı gösterebilme özelliği.
- Düşük sıcaklıklı veya yüksek sıcaklıklı buhar üretebilme özelliği.
- Kendi kendini yıkayabilme özelliği.

English

ELECTRIC COMBI OVENS

- 400 V. 50 Hz operation power.
- ECO function for consumption reduction in cooking.
- SC2 semi automatic washing.
- Cooking modes: manual or programmable selection, 99 programs with 4 phases of whom 7 are standard, 3 re-heating programs, 5 smoking, 4 Low Temperature and 1 Delta T.
- Single-point temperature core probe.
- UR2 automatic humidity control while cooking.
- RDC steam generator with low management cost.
- Automatic fan reverse AWC, 2 fan speeds.
- Digital controls.
- Manual steam injection.
- Self-diagnosis with malfunction alarms.
- IPX5 protection degree.
- Door double tempered glazing.
- AISI 304 stainless steel polished cooking chamber ,with AISI 316L (1,2 mm) top and bottom and rounded edges without joints.
- Handle with double handgrip, easier opening also with hands full.
- Automatic Cooling and Preheating.
- Start-up time selection.
- Display of set and current cooking values.
- Low temperature steam and Superheated steam.
- Self cleaning system.

Elektrikli Kombi Fırınlar
Electric Combi Ovens

Kod Code	Ürün Adı Description	Ebatlar Dimension mm			Ağırlık Weight kg	Net Net m³	Güç Power kw	Yükleme Kapasite Loading Capacity porsiyon	Fiyatı Price Euro
		a	b	c					
EMPCBE24	Elektrikli Kombi Fırınlar 12 Gn 2/1 Electric Combi Oven 12 Gn 2/1	1178	1064	1190	278	2.9	27.5	335	11.825
EMPCBE24-AS	Alt Stand 12 Gn 2/1 Bottom Stand 12 Gn 2/1	1210	860	600	32	0.6			530



Kod Code	Ürün Adı Description	Ebatlar Dimension mm			Ağırlık Weight kg	Net Net m³	Güç Power kw	Yükleme Kapasite Loading Capacity porsiyon	Fiyatı Price Euro
		a	b	c					
EMPCBE40	Elektrikli Kombi Fırınlar 40 Gn 1/1 Electric Combi Oven 40 Gn 1/1	1190	1074	1795	449	3.4	55.5	560	21.450
EMPCBG40. TA-16	Tepsi Taşıma Arabası ve Tepsi Kiti Tray Carrying Trolley and Tray Kit	590	750	1700	77	1.5		15 40x60	2.350
EMPCBG40. TA-20	Tepsi Taşıma Arabası ve Tepsi Kiti Tray Carrying Trolley and Tray Kit	820	920	1710	77	1.5		20 GN-2/1	2.450

Tütsüleme Kiti
Smoking Kit

Kod Code	Ürün Adı Description	Ebatlar Dimension mm			Ağırlık Weight kg	Net Net m³	Güç Power kw	Fiyatı Price Euro
		a	b	c				
EMPTTK01	Tütsüleme Kiti Smoking Kit	230	355	120	5.2	0.01	0.15	1.200

Türkçe
ELEKTRİKLİ KOMBİ FIRINLAR

- 400 V. 50 Hz çalışma gücü.
- Pişirme sırasında enerji sarfiyatını düşüren ECO fonksiyonu.
- SC2 yarı otomatik yıkama.
- 99 programlı pişirme hafızası : 4 fazlı; 3 ısıtma, 4 düşük dereceli pişirme ve 1 delta T programı.
- Tek noktalı pişirme probu.
- UR2 pişirme esnasında otomatik nem kontrolü.
- RDC ekonomik buhar jenerasyonu sistemi.
- Ters yönlü 2 kademeli AWC fan.
- Dijital kontrol.
- Manuel buhar enjeksiyonu.
- Alarmla uyarı verebilen arıza teşhis özelliği.
- IPX5 koruma derecesi.
- Çift temperli camlı kapı.
- 304 kalite paslanmaz dış gövde, 316 kalite fırın iç yapısı.
- Ergonomik kapı kulbu.
- Kapalı kapı ile fırın içi soğutma fonksiyonu.
- Pişirme başlangıç saatinin ayarlanabilme özelliği.
- Set edilen ve ölçülen sıcaklık değerlerini ayrı ayrı gösterebilme özelliği.
- Düşük sıcaklıklı veya yüksek sıcaklıklı buhar üretebilme özelliği.
- Kendi kendini yıkayabilme özelliği.

- Kendi kendini yıkayabilme özelliği.

English
ELECTRIC COMBI OVENS

- 400 V. 50 Hz operation power.
- ECO function for consumption reduction in cooking.
- SC2 semi automatic washing.
- Cooking modes: manual or programmable selection, 99 programs with 4 phases of whom 7 are standard, 3 re-heating programs, 5 smoking, 4 Low Temperature and 1 Delta T.
- Single-point temperature core probe.
- UR2 automatic humidity control while cooking.
- RDC steam generator with low management cost.
- Automatic fan reverse AWC, 2 fan speeds.
- Digital controls.
- Manual steam injection.
- Self-diagnosis with malfunction alarms.
- IPX5 protection degree.
- Door double tempered glazing.
- AISI 304 stainless steel polished cooking chamber ,with AISI 316L (1,2 mm) top and bottom and rounded edges without joints.
- Handle with double handgrip, easier opening also with hands full.
- Automatic Cooling and Preheating.
- Start-up time selection.
- Display of set and current cooking values.
- Low temperature steam and Superheated steam.
- Self cleaning system.

Tüm modellerde tepsi kitleri fiyatlarına dahildir.

Tray kits are included in the price for each model.

- Bir adet 40GN-1/1 tepsi taşıma arabası ve tepsi kiti fiyata dahildir.

- One piece of 40GN-1/1 tray carrying trolley and tray kit is included in the price

Şok Dondurucu
Blast Freezer / Chiller

Kod Code	Ürün Adı Description	Ebatlar Dimension mm			Ağırlık Weight kg	Güç Power kw	Tepsi Kapasitesi Tray Capacity Gn 1/1-60x40	Fiyatı Price Euro
		a	b	c				
EMP.BL-7	Şok Dondurucu Blast Freezer / Chiller	800x750x1410			201	2.2	7	3.700



Kod Code	Ürün Adı Description	Ebatlar Dimension mm			Ağırlık Weight kg	Güç Power kw	Tepsi Kapasitesi Tray Capacity Gn 1/1-60x40	Fiyatı Price Euro
		a	b	c				
EMP.BL-10	Şok Dondurucu Blast Freezer / Chiller	800x750x1410			201	2.2	10	3.850



Kod Code	Ürün Adı Description	Ebatlar Dimension mm			Ağırlık Weight kg	Güç Power kw	Tepsi Kapasitesi Tray Capacity Gn 1/1-60x40	Fiyatı Price Euro
		a	b	c				
EMP.BL-15	Şok Dondurucu Blast Freezer / Chiller	800x850x2010			263	3.5	15	7.690



Kod Code	Ürün Adı Description	Fiyatı Price Euro
EMP.BL-T	1 Tekerlek 1 Wheel	30



Türkçe

ŞOK DONDURUCU

EMP.BL-7 için;
- 30 kg 90 dakikada + 3 °C düşürme kapasitesi.
- 25 kg 90 dakikada - 22 °C düşürme kapasitesi.

EMP.BL-10 ve EMP.BL-15 için;
- 35 kg 90 dakikada + 3 °C düşürme kapasitesi.
- 30 kg 90 dakikada - 22 °C düşürme kapasitesi.
- Soğutma sıcaklığı +90 °C ,+3 °C.
- Dondurma sıcaklığı +90 °C , -18 °C.
- 380 V -1 +N - 50 Hz elektrik gücü.
- "CFC Free" , 404A soğutucu gaz.
- 60 mm izolasyon kalınlığı.
- 40 kg/m3 yoğunluk.
- Defrost esnasında otomatik su buharlaştırma.
- Özel kapı menteşe sistemi.
- Temizlenebilir ve sökülebilir manyetik kapı contası.
- Paslanmaz çelik gövde.

English

BLAST FREEZER / CHILLER

EMP.BL-7;
- +3 °C Chilling temperature for 30 kg in 90 minutes.
- -22 °C Freezing temperature for 25 kg in 90 minutes.

EMP.BL-10 and EMP.BL-15;
- +3 °C Chilling temperature for 35 kg in 90 minutes.
- -22 °C Freezing temperature for 30 kg in 90 minutes.
- Chilling temperature +90 °C ,+3 °C.
- Freezing temperature +90 °C , -18 °C.
- 380 V -1 +N - 50 Hz electrical power.
- "CFC Free" , 404A gas.
- 60 mm insulation thickness.
- 40 kg/m3 density.
- Automatic evaporation of water during defrosting.
- Special door and hinge system.
- Removable and easy cleaning magnetic gaskets.
- Stainless steel body.

Şok Dondurucu
Blast Freezer / Chiller

Kod Code	Ürün Adı Description	Ebatlar Dimension mm			Ağırlık Weight kg	Güç Power kw	Tepsi Kapasitesi Tray Capacity Gn 1/1-60x40	Fiyatı Price Euro
		a	b	c				
EMP.BL-5	Şok Dondurucu Blast Freezer / Chiller	800	750	850	132	1.2	5	3.200



Kod Code	Ürün Adı Description	Ebatlar Dimension mm			Ağırlık Weight kg	Güç Power kw	Tepsi Kapasitesi Tray Capacity Gn 1/1-60x40	Fiyatı Price Euro
		a	b	c				
EMP.BL-5F	Şok Dondurucu Blast Freezer / Chiller	900	1010	1060	150	1.2	5	4.800

Fırın altı kullanıma uygundur. / Suitable to use underneath the oven.



Kod Code	Ürün Adı Description	Fiyatı Price Euro
EMP.BL-T	1 Tekerlek 1 Wheel	30

Türkçe

ŞOK DONDURCU

- 20 kg 90 dakikada +3 °C düşürme kapasitesi.
- 15 kg 90 dakikada -22 °C düşürme kapasitesi.
- Soğutma sıcaklığı +90 °C ,+3 °C.
- Dondurma sıcaklığı +90 °C , -18 °C.
- 380 V -1 +N - 50 Hz elektrik gücü.
- "CFC Free" , 404A soğutucu gaz.
- 60 mm izolasyon kalınlığı.
- 40 kg/m3 yoğunluk.
- Defrost esnasında otomatik su buharlaştırma.
- Özel kapı menteşe sistemi.
- Temizlenebilir ve sökülebilir manyetik kapı contası.
- Paslanmaz çelik gövde.

English

BLAST FREEZER / CHILLER

- +3 °C Chilling temperature for 20 kg in 90 minutes.
- -22 °C Freezing temperature for 15 kg in 90 minutes.
- Chilling temperature +90 °C ,+3 °C.
- Freezing temperature +90 °C , -18 °C.
- 380 V -1 +N - 50 Hz electrical power.
- "CFC Free" , 404A gas.
- 60 mm insulation thickness.
- 40 kg/m3 density.
- Automatic evaporation of water during defrosting.
- Special door and hinge system.
- Removable and easy cleaning magnetic gaskets.
- Stainless steel body.



**Fırınlar (Pastane)
Ovens (Patisserie)**

Fırınlar
Ovens

- Mini Konveksiyonlu Fırınlar (Elektrikli) / Mini Convection Ovens (Electric) ***
- Konveksiyonlu Patisserie Fırınları (Elektrikli) / Convection Patisserie Ovens (Electric) ***
- Plus Konveksiyonlu Patisserie Fırınları (Gazlı) / Plus Convection Patisserie Ovens (Gas) ***
- Plus Konveksiyonlu Patisserie Fırınları (Elektrikli) / Plus Convection Patisserie Ovens (Electric) ***
- Kombi Fırın (Büyük - Küçük) Model / Combi Oven (Big - Small) Model ***
- Elektrikli Modüler Fırın (Dijital Kumandalı) / Electric Deck Oven (Digital Control) ***
- Döner Konveksiyonlu Fırınlar - Elektrikli / Convection Rotary Ovens-Electrical ***
- Döner Konveksiyonlu Fırınlar - Gazlı / Convection Rotary Ovens-Gas ***
- Profesyonel Mayalandırma Kabini / Proofer ***

Mini Konveksiyonlu Fırınlar (Elektrikli)
Mini Convection Ovens (Electric)

EMP.PFE423-U
Mini Konveksiyonlu Fırın-Üstten Açılır
Mini Convection Ovens-Top Opening

EMP.PFE423-Y
Mini Konveksiyonlu Fırın-Yana Açılır
Mini Convection Ovens-Side Opening

Kod Code	Ürün Adı Description	Ebatlar Dimension mm			Ağırlık Weight kg	Net Net m³	Güç Power kw	Kapasite Capacity	Fiyatı Price Euro
		a	b	c					
EMP.PFE423-U	Mini Konveksiyonlu Fırın-Üstten Açılır - Elektrikli Mini Convection Ovens-Top Opening - Electrical	510	702	560	45	0.2	3 Kw - 220 V	4 x (2/3 GN)	975
EMP.PFE423-Y	Mini Konveksiyonlu Fırın-Yana Açılır - Elektrikli Mini Convection Ovens-Side Opening - Electrical	510	702	560	55	0.2	3 Kw - 220 V	4 x (2/3 GN)	1.350

Kod Code	Elektrik Girişi Electric Input V	Kablo Kesiti Cable Cross Section mm²
EMP.PFE423-U	220	3x1,5
EMP.PFE423-Y	220	3x2,5

Türkçe
MINİ KONVEKSİYONLU FIRINLAR (ELEKTRİKLİ)
EMP.PFE423-Y;

- Çift yöne dönebilen fan ile eşit ısı dağılımı.
- Manuel buhar verme.
- Silikon contalı temperlenmiş cam.
- Sensörlü kapı sistemi.
- Paslanmaz çelik gövde.

EMP.PFE423-U

- Tek yöne dönüşlü fan.
- Silikon contalı temperlenmiş cam.
- Sensörlü kapı sistemi.
- Paslanmaz çelik gövde.

English
MINI CONVECTION OVENS (ELECTRIC)
EMP.PFE423-Y;

- Dual direction fan provides homogenous heat distribution.
- Manuel steamer.
- Silicone sealed tempered glass.
- Switch system on the door.
- Stainless steel body.

EMP.PFE423-U

- Single direction fan.
- Silicone sealed tempered glass.
- Switch system on the door.
- Stainless steel body.

EMP.PFE423-Y

EMP.PFE423-U

Konveksiyonlu Patisserie Fırınları (Elektrikli) Convection Patisserie Ovens (Electric)



EMP.PFE4-U
Konveksiyonlu Patisserie Fırını-Üstten Açılır
Convection Patisserie Ovens-Top Opening



EMP.PFE4-Y
Konveksiyonlu Patisserie Fırını-Yana Açılır
Convection Patisserie Ovens-Side Opening

Kod Code	Ürün Adı Description	Ebatlar Dimension mm			Ağırlık Weight kg	Net Net m³	Güç Power kw	Kapasite Capacity	Fiyatı Price Euro
		a	b	c					
EMP.PFE4-U	Konveksiyonlu Patisserie Fırını-Üstten Açılır - Elektrikli Convection Patisserie Ovens-Top Opening - Electrical	800	845	560	75	0.36	7 Kw- 220 V	4-40x60	1.680
EMP.PFE4-Y	Konveksiyonlu Patisserie Fırını-Yana Açılır - Elektrikli Convection Patisserie Ovens-Side Opening - Electrical	800	855	565	75	0.4	7 Kw - 220 V	4-40x60	1.890
EMP.PFE6-Y	Konveksiyonlu Patisserie Fırını-Yana Açılır - Elektrikli Convection Patisserie Ovens-Side Opening - Electrical	800	855	700	85	0.5	10 Kw- 380 V	6-40x60	2.200
EMP.MF4-6	Mayalandırma Kabini Fermentation Cabinet	800	790	850	65	0.6	1.6	8-40x60	800

Kod Code	Elektrik Girişi Electric Input V	Kablo Kesiti Cable Cross Section mm²
EMP.PFE4-U	220	5x2,5
EMP.PFE4-Y	220	5x2,5
EMP.PFE6-Y	380	5x2,5
EMP.MF4-6	220	3x2,5

Türkçe

KONVEKSİYONLU PATISSERIE FIRINLARI (ELEKTRİKLİ)

- Aydınlatmalı dokunmatik buton.
- 99 çeşit program hafıza kapasitesi.
- Çift yöne dönebilen fan ile eşit ısı dağılımı.
- Manuel buhar verme.
- Silikon contalı temperlenmiş cam.
- Sensörlü kapı sistemi.
- Paslanmaz çelik gövde.
- Adımlı Pişirme Özelliği.

English

CONVECTION PATISSERIE OVENS (ELECTRIC)

- Illustrated food menu upload option through external memory.
- 99 different kind of programme upload options.
- Dual direction fan provides homogenous heat distribution.
- Manuel steamer.
- Silicone sealed tempered glass.
- Switch system on the door.
- Stainless steel body.
- Step Cooking Option



EMP.MF4-6
Mayalandırma Kabini
Fermentation Cabinet

Su geçirmez touch kontrol paneli
Water proof touch panel control



Plus Konveksiyonlu Patisserie Fırınları (Gazlı) Plus Convection Patisserie Ovens (Gas)



Kod Code	Ürün Adı Description	Ebatlar Dimension mm			Ağırlık Weight kg	Net Net m³	Güç Power kw	Kapasite Capacity	Fiyatı Price Euro
		a	b	c					
EMP.PFG8	P.Konveksiyonlu Patisserie Fırını - Gazlı P.Convection Patisserie Oven - Gas	1050	1010	1350	220	1.43	35 Kw 380 V 3-50 Hz	8-40x60	5.100
EMP.MF8	Mayalandırma Kabini Fermentation Cabinet	1030	950	850	110	0.72	2.5 Kw 220 V 3-50 Hz	8-40x60	800
EMP.AS8	Alt Stand Bottom Stand	1030	950	850	28	0.72			420

Kod Code	Gaz Tüketim Değeri Gas Consumption Ng	Gaz Tüketim Değeri Gas Consumption Lpg
EMP.PFG8	3,70 m³/h	2,74 kg/h

Türkçe

PLUS KONVEKSİYONLU PATISSERIE FIRINLARI (GAZ)

- 7 inç renkli LCD ekran kontrol paneli.
- Aydınlatmalı dokunmatik buton.
- Çok adımlı pişirebilme özelliği.
- Harici bellek ile hafızaya yemek menüsü yükleyebilme özelliği.
- 99 çeşit program hafıza kapasitesi.
- Ekran üzerinden program ismi tanımlama özelliği.
- Manuel veya otomatik nemlendirme özelliği.
- Ekran üzerinden kullanım kılavuzuna ulaşabilme özelliği.
- Ayarlanabilir pişirme süresi ve dijital göstergesi.
- 0° C- 300° C arasında ayarlanabilir pişirme sıcaklığı ve dijital göstergesi.
- 360° C lik limit termostat.
- Paslanmaz çelik kapalı sistem ısı transfer boruları.
- Lpg ve Ng ile çalışabilme özelliği.
- Fırın içi temizlik duş sprey ünitesi.
- 2 hızlı paslanmaz çelik fan.
- Çift yöne dönebilen fan ile eşit ısı dağılımı.
- Silikon contalı temperlenmiş cam.
- Kolay temizlik imkanı sağlayan açılabilir iç cam.
- Sensörlü kapı sistemi.
- Paslanmaz çelik gövde.

English

PLUS CONVECTION PATISSERIE OVENS (GAS)

- 7 inch touch screen LCD control panel.
- Illustrated food menu upload option through external memory.
- 99 different kind of programme upload options.
- Programme name defining option through touch screen.
- Manual and periodic steamer.
- User manuel accessibility through touch screen.
- Adjustable cooking time.
- Adjustable cooking temperature between 0° C- 300° C
- Safety thermostat for overheating protection (360° C).
- Stainless steel heat exchanger sealed system pipes.
- Lpg or Natural Gas.
- Retractable shower.
- 2 speed stainless steel fan.
- Dual direction fan provides homogenous heat distribution.
- Silicone sealed tempered glass.
- Easy-access interior glass in order to provide cleaning.
- Door switch system.
- Stainless steel body.



Su geçirmez touch kontrol paneli
Water proof touch panel control

Plus Konveksiyonlu Patisserie Fırınları (Elektrikli)
Plus Convection Patisserie Ovens (Electric)



Kod Code	Ürün Adı Description	Ebatlar Dimension mm			Ağırlık Weight kg	Net Net m³	Güç Power kw	Kapasite Capacity	Fiyatı Price Euro
		a	b	c					
EMP.PFE8	P.Konveksiyonlu Patisserie Fırını - Elektrikli P.Convection Patisserie Oven - Electrical	1040	1050	1350	202	1.42	19.5 Kw 380 V 3-50 Hz	8-40x60	5.100
EMP.MF8	Mayalandırma Kabini Fermantation Cabinet	1030	950	850	62	0.72	2.5 Kw 220 V 3-50 Hz	8-40x60	800
EMP.AS8	Alt Stand Bottom Stand	1030	950	850	28	0.72			420

Kod Code	Elektrik Girişi Electric Input V	Kablo Kesiti Cable Cross Section mm²
EMP.PFE8	380	5x6
EMP.MF8	220	3x2,5

Türkçe

PLUS KONVEKSİYONLU PATISSERIE FIRINLAR
(ELEKTRİKLİ)

- 7 inç renkli LCD ekran kontrol paneli.
- Aydınlatmalı dokunmatik buton.
- Çok adımlı pişirebilme özelliği.
- Harici bellek ile hafızaya yemek menüsü yükleyebilme özelliği.
- 99 çeşit program hafıza kapasitesi.
- Ekran üzerinden program ismi tanımlama özelliği.
- Manuel veya otomatik nemlendirme özelliği.
- Ekran üzerinden kullanım kılavuzuna ulaşabilme özelliği.
- Ayarlanabilir pişirme süresi ve dijital göstergesi.
- 0° C- 300° C arasında ayarlanabilir pişirme sıcaklığı ve dijital göstergesi.
- 360° C lik limit termostat.
- PID sistemiyle hassas ısı kontrolü. (SSR rölesi)
- Fırın içi temizlik duş sprey ünitesi.
- 2 hızlı paslanmaz çelik fan.
- Çift yöne dönebilen fan ile eşit ısı dağılımı.
- Silikon contalı temperlenmiş cam.
- Kolay temizlik imkanı sağlayan açılabilir iç cam.
- Sensörlü kapı sistemi.
- Paslanmaz çelik gövde.

English

PLUS CONVECTION PATISSERIE OVENS
(ELECTRIC)

- 7 inch touch screen LCD control panel.
- Illustrated food menu upload option through external memory.
- 99 different kind of programme upload options.
- Programme name defining option through touch screen.
- Manual and periodic steamer.
- User manuel accessibility through touch screen.
- Adjustable cooking time.
- Adjustable cooking temperature between 0° C- 300° C
- Safety thermostat for overheating protection (360° C).
- PID system provide sensitive heating (SSR relay)
- Retractable shower.
- 2 speed stainless steel fan.
- Dual direction fan provides homogenous heat distribution.
- Silicone sealed tempered glass.
- Easy-access interior glass in order to provide cleaning.
- Door switch system.
- Stainless steel body.



Su geçirmez touch kontrol paneli
Water proof touch panel control

Kombi Fırın (Büyük - Küçük) Model
Combi Oven (Big - Small) Model

Su geçirmez touch kontrol paneli
Water proof touch panel control

Kod Code	Ürün Adı Description	Ebatlar Dimension mm			Ağırlık Weight kg	Net Net m³	Güç Power kw	Fiyatı Price Euro
		a	b	c				
EMP.PFE.4+5-Y-B	Kombi Fırın Büyük Model Combi Oven Big Model	1030x1151x1202			182	1.42	14.5 Kw	3.860
EMP.MF8-B	Mayalandırma Kabini Fermentation Cabinet	1030x984x850			90	0.86	2.5 Kw	1.050
EMP.PFE.4+5.Y-K	Kombi Fırın Küçük Model Combi Oven Small Model	1030x961x1202			162	1.19	13 Kw	3.500
EMP.MF8-K	Mayalandırma Kabini Fermentation Cabinet	1030x794x850			80	0.69	2.5 Kw	945

Türkçe
KOMBİ FIRIN BÜYÜK MODEL

- 14.5 Kw makine toplam gücü.
- Konveksiyonlu fırın için;400x600 mm 4 tepsi kapasitesi.
- Pizza fırını için ;400x600 mm 2 tepsi kapasitesi.
- Ø 250 mm'lik 7 adet pizza kapasitesi.
- Termostatik sıcaklık kontrol ayarı.
- Dijital kontrollü pişirme süresi ve dijital kontrollü pişirme sıcaklığı.
- Çift yöne dönebilen fan ile eşit ısı dağılımı.
- Silikon contalı temperlenmiş cam.
- Manuel buhar verme.
- Sensörlü kapı sistemi.
- Dijital iç sıcaklık göstergesi.
- Ayarlanabilir üst ve alt ısı verimleri.
- Paslanmaz çelik gövde.

KOMBİ FIRIN KÜÇÜK MODEL

- 13 Kw makine toplam gücü.
- Konveksiyonlu fırın için;400x600 mm 4 tepsi kapasitesi.
- Pizza fırını için ;400x600 mm 1 tepsi kapasitesi.
- Ø 250 mm'lik 5 adet pizza kapasitesi.
- Termostatik sıcaklık kontrol ayarı.
- Dijital kontrollü pişirme süresi ve dijital kontrollü pişirme sıcaklığı.
- Çift yöne dönebilen fan ile eşit ısı dağılımı.
- Silikon contalı temperlenmiş cam.
- Manuel buhar verme.
- Sensörlü kapı sistemi.
- Dijital iç sıcaklık göstergesi.
- Ayarlanabilir üst ve alt ısı verimleri.
- Paslanmaz çelik gövde.

English
COMBI OVEN BIG MODEL

- 14.5 Kw total power.
- Tray capacity for convection oven ; 4 trays of 400x600 mm
- Tray capacity for pizza oven; 2 tray of 400x600 mm
- Pizza capacity: 7 pieces Ø 250 mm
- Thermostatic electronic heating control setting.
- Digital controlled cooking time and temperature.
- Dual direction fan provides homogenous heat distribution
- Silicon sealed tempered glass.
- Manuel steamer.
- Switch system on the door.
- Digital interior temperature indicator.
- Adjustable top and bottom heating output.
- Stainless steel body.

COMBI OVEN SMALL MODEL

- 13 Kw total power.
- Tray capacity for convection oven ; 4 trays of 400x600 mm
- Tray capacity for pizza oven; 1 tray of 400x600 mm
- Pizza capacity:5 pieces Ø 250 mm
- Thermostatic electronic heating control setting.
- Digital controlled cooking time and temperature.
- Dual direction fan provides homogenous heat distribution.
- Silicon sealed tempered glass.
- Manuel steamer.
- Switch system on the door.
- Digital interior temperature indicator.
- Adjustable top and bottom heating output.
- Stainless steel body.



Elektrikli Modüler Fırın (Dijital Kumandalı)
Electric Deck Oven (Digital Control)



Kod Code	Ürün Adı Description	Ebatlar Dimension mm			İç Ebatlar Interior Dimensions mm	Ağırlık Weight kg	Net Net m³	Güç Power kw	Fiyatı Price Euro
		a	b	c					
EMP.3545-6	Elektrikli Modüler Fırın (Tek Kat) Deck Oven (Single Layer)	1720	1280	350	1225x915x213	279	0.88	12 Kw 380 V 3-50 Hz	4.620
EMP.3545-6D	Elektrikli Modüler Fırın Davlumbazı Hood	1720	1460	350		33	0.68		290
EMP.3545-6M	Elektrikli Modüler Fırın Mayalandırma Kabini Fermentation Cabinet	1720	1280	1011		180	1.85	2 Kw 220 V 3-50 Hz	2.100
EMP.3545-6S	Elektrikli Modüler Fırın Alt Stand Bottom Stand	1720	1280	1011		66	1.75		1.155
EMP.3545-6A	Elektrikli Modüler Fırın Ara Kat Middle Layer	1720	1280	300		23	0.60		685

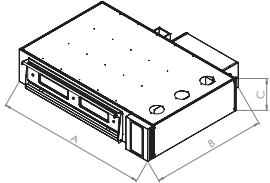

EMP.3545-6

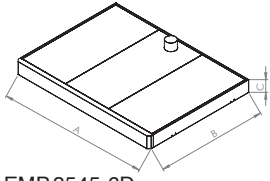

EMP.3545-6D

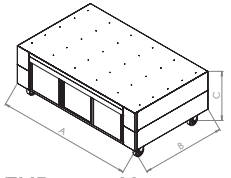

EMP.3545-6M



Su geçirmez touch kontrol paneli
Water proof touch panel control

Türkçe

ELEKTRİKLİ MODÜLER FIRIN
(DİJİTAL KUMANDALI)

- 4.3 inç renkli LCD ekran kontrol paneli.
- Harici bellek ile hafızaya yemek menüsü yükleyebilme özelliği.
- 99 ayrı program özelliği.
- Ekran üzerinden yemek ismi tanımlama özelliği.
- Manuel veya otomatik nemlendirme özelliği.
- Ekran üzerinden kullanım kılavuzuna ulaşabilme özelliği.
- Ayarlanabilir pişirme süresi ve dijital göstergesi.
- 0° C- 300° C arasında ayarlanabilir pişirme sıcaklığı ve dijital göstergesi.
- 360° C lik limit termostat.
- 12 Kw 380 V fırın gücü.
- 350x450 mm'lik 6 tepsi veya 400x600 mm'lik 4 tepsili fırın kapasitesi.
- 1225 mm x 920 mm fırın iç ölçüsü.
- Ayarlanabilir alt ve üst ısı sıcaklıkları.
- Eşit ısı dağılımı.
- Paslanmaz çelik boru rezistans.
- Paslanmaz çelik gövde.
- İsteğe göre tek, iki veya üç kat yapılabilir.

Mayalandırma Kabini

- 2.5 Kw güç.
- 2x5 bölmeli. (400 mm x 600 mm)
- Ayrı ayrı ayarlanabilir ısı ve nem seviyeleri.

Buhar jeneratörü standarttır.

English

ELECTRIC DECK OVEN (DIGITAL CONTROL)

- 4.3 inch touch screen LCD control panel.
- Illustrated food menu upload option through external memory.
- 99 different cooking programme.
- Food name defining option through touch screen.
- Manual and periodic steamer.
- User manual accessibility through touch screen.
- Adjustable cooking time.
- Adjustable cooking temperature between 0° C- 300° C
- Safety thermostat for overheating protection (360° C).
- Power:12 Kw 380 V
- Capacity. 6 no's of 350x450 mm trays or 4 no's of 400x600 mm trays .
- Interior dimension:1225 mm x 920 mm
- Adjustable top and bottom heating output.
- Homogenous heat distribution.
- Stainless steel pipe resistance.
- Stainless steel body.
- According to demand single,double or triple layer options.

Fermentation Cabinet

- 2.5 Kw power.
- 2x5 layers. (400 mm x 600 mm)
- Adjustable temperature and humidity levels.

Steam generator is standard.

Döner Konveksiyonlu Fırınlar - Elektrikli
Convection Rotary Ovens-Electrical

Kod Code	Ürün Adı Description	Ebatlar Dimension mm			Ağırlık Weight kg	Net Net m ³	Güç Power kw	Kapasite Capacity	Fiyatı Price Euro
		a	b	c					
EMP.EDKF-10	Döner Konv. Fırınlar Convection Rotary Ovens	990	960	2240	350	1.20	26.5 Kw 380 V 50-60 Hz	10-40x60	9.900



Kod Code	Ürün Adı Description	Ebatlar Dimension mm			Ağırlık Weight kg	Net Net m ³	Güç Power kw	Kapasite Capacity	Fiyatı Price Euro
		a	b	c					
EMP.EDKF-10-B	Döner Konv. Fırınlar Convection Rotary Ovens	990	960	2240	350	1.20	26.5 Kw 380 V 50-60 Hz	10-40x60	10.900

Türkçe
DÖNER KONVEKSİYONLU FIRINLAR - ELEKTRİKLİ

- 10x(40x60) tava kapasitesi.
- 7 inç renkli LCD ekran kontrol paneli.
- Aydınlatmalı dokunmatik buton.
- Farklı motor hızlarında çalışabilme özelliği.
- Harici bellek ile hafızaya menü yükleyebilme özelliği.
- Ayarlanabilir pişirme süresi ve dijital göstergesi.
- 0° C- 300° C arasında ayarlanabilir pişirme sıcaklığı ve dijital göstergesi.
- 360° C lik limit termostat.
- Dönerli sistem sayesinde tüm tavalarda ve tavaların her bölgesinde eşit pişirme imkanı.
- Ayarlanabilir hava kanalları ile eşit ısı kanalları.
- Kaset sistemi ile yüksek yoğunlukta buhar elde edebilme imkanı.
- Yüksek verimli elektrik rezistansları ile minimum maliyetli pişirme.
- Halojenli aydınlatma özelliği
- **Standart fermantasyon kabini ve davlumbaz.**
- Kolay temizlik imkanı sağlayan açılabilir iç cam.
- Sensörlü kapı sistemi.
- Paslanmaz çelik gövde.

Türkçe
MAYALANDIRMA KABİNİ

- 12x(40x60) tava kapasitesi.
- 4 Kw elektrik gücü.
- Paslanmaz çelik gövde.

English
CONVECTION ROTARY OVENS - ELECTRICAL

- 10x(40x60) tray capacity.
- 7 inch touch screen LCD control panel.
- Illustrated menu upload option through external memory.
- Adjustable cooking time.
- Adjustable cooking temperature between 0° C- 300° C
- Safety thermostat for overheating protection (360° C).
- Provide homogenic cooking due to rotary system.
- Homogenic heating due to adjustable air system.
- Casette system provides high density evaporation.
- Due to high efficiency resistance.
- Halogenic lighting.
- **Equipped with proofing cabinet and hood.**
- Easy-access interior glass in order to provide cleaning.
- Door switch system.
- Stainless steel body.

English
PROOFING CABINET

- 12x(40x60) tray capacity.
- 4 Kw electric power.
- Stainless steel body.

Döner Konveksiyonlu Fırınlar - Gazlı
Convection Rotary Ovens-Gas



Kod Code	Ürün Adı Description	Ebatlar Dimension mm			Ağırlık Weight kg	Net Net m³	Güç Power kw	Kapasite Capacity	Fiyatı Price Euro
		a	b	c					
EMP.GDKF-10	Döner Konv. Fırınlar Convection Rotary Ovens	990	960	2240	350	1.20	46.43 Kw 220 V 50-60 Hz	10-40x60	9.900



Kod Code	Ürün Adı Description	Ebatlar Dimension mm			Ağırlık Weight kg	Net Net m³	Güç Power kw	Kapasite Capacity	Fiyatı Price Euro
		a	b	c					
EMP.GDKF-10-B	Döner Konv. Fırınlar Convection Rotary Ovens	990	960	2240	350	1.20	46.50 Kw 220 V 50-60 Hz	10-40x60	10.900



Türkçe

DÖNER KONVEKSİYONLU FIRINLAR - GAZLI

- LPG ve Doğalgaz ile çalışabilme özelliği.
- 10x(40x60) tava kapasitesi.
- 7 inç renkli LCD ekran kontrol paneli.
- Aydınlatmalı dokunmatik buton.
- Farklı motor hızlarında çalışabilme özelliği.
- Harici bellek ile hafızaya menü yükleyebilme özelliği.
- Ayarlanabilir pişirme süresi ve dijital göstergesi.
- 0° C- 300° C arasında ayarlanabilir pişirme sıcaklığı ve dijital göstergesi.
- 360° C lik limit termostat.
- Dönerli sistem sayesinde tüm tavalarda ve tavaların her bölgesinde eşit pişirme imkanı.
- Ayarlanabilir hava kanalları ile eşit ısı kanalları.
- Kaset sistemi ile yüksek yoğunlukta buhar elde edebilme imkanı.
- Yüksek verimli elektrik rezistanları ile minimum maliyetli pişirme.
- Halojenli aydınlatma özelliği
- Standart fermantasyon kabini ve davlumbaz.
- Kolay temizlik imkanı sağlayan açılabilir iç cam.
- Sensörlü kapı sistemi.
- Paslanmaz çelik gövde.

Türkçe

MAYALANDIRMA KABİNİ

- 12x(40x60) tava kapasitesi.
- 4 Kw elektrik gücü.
- Paslanmaz çelik gövde.

English

CONVECTION ROTARY OVENS - GAS

- LPG or Natural gas.
- 10x(40x60) tray capacity.
- 7 inch touch screen LCD control panel.
- Illustrated menu upload option through external memory.
- Adjustable cooking time.
- Adjustable cooking temperature between 0° C- 300° C
- Safety thermostat for overheating protection (360° C).
- Provide homogenic cooking due to rotary system.
- Homogenic heating due to adjustable air system.
- Cassette system provides high density evaporation.
- Due to high efficiency resistance.
- Halogenic lighting.
- Equipped with proofing cabinet and hood.
- Easy-access interior glass in order to provide cleaning.
- Door switch system.
- Stainless steel body.

English

PROOFING CABINET

- 12x(40x60) tray capacity.
- 4 Kw electric power.
- Stainless steel body.



EMP.MF.20

Profesyonel Mayalandırma Kabini
Proofer

Kod Code	Ürün Adı Description	Ebatlar Dimension mm			Ağırlık Weight kg	Net Net m ³	Güç Power kw	Kapasite Capacity	Fiyatı Price Euro
		a	b	c					
EMP.MF.20	Profesyonel Mayalandırma Kabini (Tek Cidarlı) Proofer (Single Jacket)	500x720x1800			80	0.7	3 Kw- 220 V	16-40x60	1.300
EMP.MF.20-T	Profesyonel Mayalandırma Kabini - Tekerlekli (Tek Cidarlı) Proofer - With Wheel (Single Jacket)	500x720x1800			83	0.7	3 Kw- 220 V	16-40x60	1.400
EMP.MFI.20	Profesyonel Mayalandırma Kabini (İzolasyonlu) Proofer (Isolated)	630x850x1900			93	1.02	3 Kw- 220 V	16-40x60	1.630
EMP.MFI.20-T	Profesyonel Mayalandırma Kabini - Tekerlekli (İzolasyonlu) Proofer - With Wheel (Isolated)	630x850x1900			96	1.02	3 Kw- 220 V	16-40x60	1.730

Türkçe

PROFESYONEL MAYALANDIRMA KABİNİ

- İzolasyonlu kabinler için;
- 40 kg/m³ yoğunluk.
- 0°C - 90°C çalışma ısısı.
- 16-40x60 tepsi kapasitesi.
- Termostatik sıcaklık kontrol ayarı.
- Buhar Rezistansı.
- Paslanmaz çelik gövde.

English

PROOFER

- For Isolated cabinet;
- 40 kg/m³ density.
- 0°C - 90°C operating temperature.
- 16-40x60 tray capacity.
- Thermostatic electronic heating control setting.
- Steam resistance.
- Stainless steel body.



EMP.MF.20-T



Pizza Fırınları Pizza Ovens

Fırınlar
Ovens

- Döner Tabanlı Elektrikli ve Gazlı Pizza Fırınları / Rotating Electric and Gas Pizza Ovens ***
- Döner Tabanlı & Sabit Gazlı Pizza Fırınları / Rotating & Non Rotating Gas Pizza Ovens ***
- Gazlı Pizza & Pide Fırını / Gas Pizza Ovens ***
- Pide Lahmacun Fırınları (Ventilli) / Pitta and Turkish Pizza Ovens (With Valve) ***
- Gold Midi ve Maxi Pizza Fırınları (Elektrikli) / Gold Midi and Maxi Pizza Ovens (Electrical) ***
- Pizza Fırınları-Tek Katlı / Single Layer Pizza Ovens ***
- Pizza Fırınları-Çift Katlı / Two Layers Pizza Ovens ***
- Pizza Fırınları (Gazlı) / Pizza Ovens (Gas) ***

Döner Tabanlı Elektrikli ve Gazlı Pizza Fırınlr
Rotating Electric and Gas Pizza Ovens

Kod Code	Ürün Adı Description	Ebatlar Dimension mm			Ağırlık Weight kg	Net Net m³	Güç Power kw	Kapasite Capacity	Fiyatı Price Euro
		a	b	c					
EMP.SPO.01	Döner Tabanlı Elektrikli Pizza Fırını Rotating Electric Pizza Oven	1200x1368x2000			330	3.32	16	Ø 300 mm 6 pizza 75 pizza / saat 75 Pizza / Hour	7.875

Kod Code	Elektrik Girişi Electric Input v	Kablo Kesiti Cable Cross Section mm²
EMP.SPO.01	380	5x4

Türkçe
DÖNER TABANLI ELEKTRİKLİ PIZZA FIRINI

- 4.3 inç renkli LCD ekran kontrol paneli.
- Harici bellek ile hafızaya menü yükleyebilme özelliği.
- 99 ayrı program özelliği.
- Ekran üzerinden program ismi tanımlama özelliği.
- Ekran üzerinden kullanım kılavuzuna ulaşabilme özelliği.
- Ayarlanabilir pişirme süresi ve dijital göstergesi.
- 0° C- 400° C arasında ayarlanabilir pişirme sıcaklığı ve dijital göstergesi.
- 450° C lik limit termostat.
- PID sistemiyle hassas ısı kontrolü. (SSR rölesi)
- 16 KW / 380 V 50 Hz. Güç.
- 170 mm fırın iç yüksekliği.
- 1000 mm fırın pişirme taşı.
- 500x140 mm kapı ölçüsü.
- Homojen pişirme sağlayan döner taban.
- Refraktör pişirme taşı.
- Paslanmaz çelik iç hazne.
- Dijital iç sıcaklık göstergesi.
- Ø 300 mm 6 pizza 75 pizza / saat.

English
ROTATING ELECTRIC PIZZA OVEN

- 4.3 inch touch screen LCD control panel.
- Illustrated menu upload option through external memory.
- 99 different cooking programme.
- Programme name defining option through touch screen.
- User manuel accessibility through touch screen.
- Adjustable cooking time.
- Adjustable cooking temperature between 0° C- 400° C
- Safety thermostat for overheating protection (450° C).
- PID system provide sensitive heating (SSR relay).
- 16 KW / 380 V 50 Hz. Power.
- Internal high : 170 mm
- Internal diameter : 1000 mm
- Door dimension : 500x140 mm
- Rotating bedplate provides homogeneous cooking.
- Baking bedplate made by refractory material.
- Stainless steel internal reservoir.
- Digital interior temperature indicator.
- Ø 300 mm 6 pizza 75 pizza / hour.

NEW

Kod Code	Ürün Adı Description	Ebatlar Dimension mm			Ağırlık Weight kg	Net Net m³	Güç Power kw	Kapasite Capacity	Fiyatı Price Euro
		a	b	c					
EMP.SPO.04	Döner Tabanlı Gazlı Pizza Fırını Rotating Gas Pizza Oven	1482x1720x1835			800	4.67	48 kw 220V 50 Hz	Ø 300 mm 6 pizza 75 pizza / saat 75 Pizza / Hour	8.900

Türkçe
DÖNER TABANLI GAZLI PIZZA FIRINI

- 4.3 inç renkli LCD ekran kontrol paneli.
- 0° C- 400° C arasında ayarlanabilir pişirme sıcaklığı ve dijital göstergesi.
- 450° C lik limit termostat.
- 220 V. 50/60 Hz. Çalışma gücü.
- LPG ve NG ile çalışabilme özelliği.
- 450 mm fırın iç yüksekliği.
- 1000 mm fırın pişirme taşı.
- **Homojen pişirme sağlayan döner taban.**
- Termostatik ısıtma.
- Refraktör pişirme taşı.
- Taş iç hazne.
- Ø 300 mm 9 pizza kapasitesi,saatte 130 pizza.

English
ROTATING GAS PIZZA OVEN

- 4.3 inch touch screen LCD control panel.
- Adjustable cooking temperature between 0° C- 400° C
- Safety thermostat for overheating protection (450° C).
- 220 V. 50/60 Hz. Operating power.
- Adaptable to LPG or NG.
- Internal high : 450 mm
- Internal diameter : 1000 mm
- **Rotating bedplate provides homogeneous cooking.**
- Thermostatic heating.
- Baking bedplate made by refractory material.
- Stone interior reservoir.
- Pizza capacity : 9 pieces of Ø 300 mm,130 pizza / hour.



Krem Cream Kahverengi Brown Siyah Black

Lütfen ürün rengini belirleyiniz.
Please specify the product colour.

Döner Tabanlı & Sabit Gazlı Pizza Fırınları Rotating & Non Rotating Gas Pizza Ovens



Hibrid / Hybrid

Kod Code	Ürün Adı Description	Ebatlar Dimension mm			Ağırlık Weight kg	Net Net m ³	Güç Power kw	Kapasite Capacity	Fiyatı Price Euro
		a	b	c					
EMP.SPO.02	Döner Tabanlı Gazlı Pizza Fırını Rotating Gas Pizza Oven	1965x2127x2000			1200	8.4	48 kw 220 V 50 Hz	Ø 300 mm 9 pizza 130 pizza / saat 130 Pizza / Hour	12.000



Türkçe

DÖNER TABANLI GAZLI PIZZA FIRINI

- 4.3 inç renkli LCD ekran kontrol paneli.
- Harici bellek ile hafızaya menü yükleyebilme özelliği.
- 99 ayrı program özelliği.
- Ekran üzerinden program ismi tanımlama özelliği.
- Ekran üzerinden kullanım kılavuzuna ulaşabilme özelliği.
- Ayarlanabilir pişirme süresi ve dijital göstergesi.
- 0° C- 400° C arasında ayarlanabilir pişirme sıcaklığı ve dijital göstergesi.
- 450° C lik limit termostat.
- PID sistemiyle hassas ısı kontrolü. (SSR röleli)
- 220 V. 50/60 Hz. Çalışma gücü.
- LPG ve NG ile çalışabilme özelliği.
- **Gazlı veya odunlu çalışabilme olanağı.**
- 450 mm fırın iç yüksekliği.
- 1200 mm fırın pişirme taşı.
- 500x250 mm kapı ölçüsü.
- Hızlı ve verimli pişirme olanağı sağlayan termal sabitleme olanağı.
- Termostatik ısıtma.
- Homojen pişirme sağlayan döner taban.
- Refraktör pişirme taşı.
- Taş iç hazne.
- Ø 300 mm 9 pizza kapasitesi,saatte 130 pizza.

English

ROTATING GAS PIZZA OVEN

- 4.3 inch touch screen LCD control panel.
- Illustrated menu upload option through external memory.
- 99 different cooking programme.
- Programme name defining option through touch screen.
- User manuel accessibility through touch screen.
- Adjustable cooking time.
- Adjustable cooking temperature between 0° C- 400° C
- Safety thermostat for overheating protection (450° C).
- PID system provide sensitive heating (SSR relay)
- 220 V. 50/60 Hz. Operating power.
- Adaptable to LPG or NG.
- **Adaptable to operate with gas or wood.**
- Internal high : 450 mm
- Internal diameter : 1200 mm
- Door dimension : 500x250 mm
- Fast and best cooking process through thermal stability.
- Thermostatic heating.
- Rotating bedplate provides homogeneous cooking.
- Baking bedplate made by refractory material.
- Stone interior reservoir.
- Pizza capacity : 9 pieces of Ø 300 mm,130 pizza / hour.



**Su geçirmez touch kontrol paneli
Water proof touch panel control**



Krem
Cream
Kahverengi
Brown
Siyah
Black

**Lütfen ürün rengini belirleyiniz.
Please specify the product colour.**

Kod Code	Ürün Adı Description	Ebatlar Dimension mm			Ağırlık Weight kg	Net Net m ³	Güç Power kw	Kapasite Capacity	Fiyatı Price Euro
		a	b	c					
EMP.SPO.03	Sabit Tabanlı Gazlı Pizza Fırını Non Rotating Gas Pizza Oven	1482x1720x1835			800	4.67	28.70 kw 220V 50 Hz	Ø 300 mm 9 pizza 130 pizza / saat 130 Pizza / Hour	7.350

Türkçe

SABİT TABANLI GAZLI PIZZA FIRINI

- 0° C- 400° C arasında ayarlanabilir pişirme sıcaklığı ve dijital göstergesi.
- 450° C lik limit termostat.
- 220 V. 50/60 Hz. Çalışma gücü.
- LPG ve NG ile çalışabilme özelliği.
- 450 mm fırın iç yüksekliği.
- 1200 mm fırın pişirme taşı.
- Termostatik ısıtma.
- Refraktör pişirme taşı.
- Taş iç hazne.
- Ø 300 mm 9 pizza kapasitesi,saatte 130 pizza.

English

NON ROTATING GAS PIZZA OVEN

- Adjustable cooking temperature between 0° C- 400° C
- Safety thermostat for overheating protection (450° C).
- 220 V. 50/60 Hz. Operating power.
- Adaptable to LPG or NG.
- Internal high : 450 mm
- Internal diameter : 1200 mm
- Thermostatic heating.
- Baking bedplate made by refractory material.
- Stone interior reservoir.
- Pizza capacity : 9 pieces of Ø 300 mm,130 pizza / hour.

Gazlı Pizza & Pide Fırını
Gas Pizza Ovens

Kod Code	Ürün Adı Description	Ebatlar Dimension mm			Ağırlık Weight kg	İç Ebatlar Interior Dimensions mm	Net Net m³	Güç Power kw	Fiyatı Price Euro
		a	b	c					
PLF.PLS.D1	Gazlı Pizza & Pide Fırını Gas Pizza Oven	1270x1500x800			270	1000x950	2.3	34	3.950
PLF.PLS.D2	Gazlı Pizza & Pide Fırını Gas Pizza Oven	1270x1750x800			315	950x1250	2.7	34	4.350
PLF.PLS.D3	Gazlı Pizza & Pide Fırını Gas Pizza Oven	1062x1037x800			180	750x600	0.78	30.40	3.250
PLF.PLS.D4	Gazlı Pizza & Pide Fırını Gas Pizza Oven	1062x1237x800			200	750x800	0,93	30.40	3.450
AS.PLF.D1	Alt Stand Bottom Stand	1180x1080x930			75		1.6		840
AS.PLF.D2	Alt Stand Bottom Stand	1180x1330x930			85		1.9		945
AS.PLF.D4	Alt Stand Bottom Stand	977x827x930			60		0,75		540
AS.PLF.D3	Alt Stand Bottom Stand	977x1027x930			68		0,93		640

Türkçe

GAZLI PİZZA & PİDE FIRINLARI

- LPG veya NG ile çalışır.
- 400° C sıcaklığa kadar çalışır.
- Alt ve üst brülörler birbirinden bağımsız çalışır.
- Musluklar Magnet Emniyet ventillidir.
- Fırın taş tabanlıdır.
- Fırın içi komple paslanmaz çeliktir.
- 4 Farklı renk seçeneği vardır.

English

GAS PIZZA OVENS

- Adaptable LPG or NG
- Working temperature: 400° C
- Independent top and bottom burners.
- Magnet Safety valves.
- Special stone floor.
- Stainless Steel oven inside.
- 4 different color options.

Kod
CodeGaz Tüketim Değeri
Gas Consumption
Ng

PLF.PLS.D1	3,59 m³/h
PLF.PLS.D2	3,59 m³/h
PLF.PLS.D3	3,20 m³/h
PLF.PLS.D4	3,20 m³/h

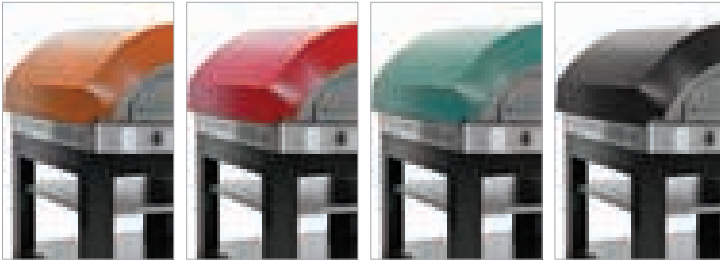
Renk Seçenekleri
Color OptionsTuruncu
OrangeKırmızı
RedYeşil
GreenSiyah
Black

Lütfen ürün rengini belirleyiniz.
Please specify the product colour.

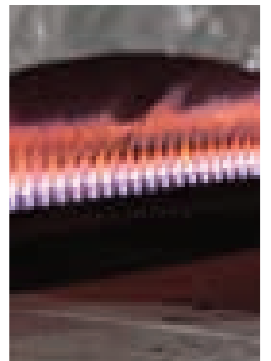

Pide Lahmacun Fırınları (Ventilli)
Pitta and Turkish Pizza Ovens (With Valve)

Kod Code	Ürün Adı Description	Ebatlar Dimension mm			İç Ebatlar Interior Dimensions mm	Net Net m ³	Güç Power kw	Fiyatı Price Euro
		a	b	c				
PLF.D1	Pide Lahmacun Fırını LPG - NG Emniyet Ventilli Pitta and Turkish Pizza LPG - NG Safety Valve	1200x1200x1720/2020			1000x1000	2.5	22	3.350
PLF.D2	Pide Lahmacun Fırını LPG - NG Emniyet Ventilli Pitta and Turkish Pizza LPG - NG Safety Valve	1200x1400x1720/2020			1000x1200	2.9	27	3.600
PLF.D4	Pide Lahmacun Fırını LPG - NG Emniyet Ventilli Pitta and Turkish Pizza LPG - NG Safety Valve	1400x1600x1720/2020			1200x1400	3.9	30	4.150
PLF.D5	Pide Lahmacun Fırını LPG - NG Emniyet Ventilli Pitta and Turkish Pizza LPG - NG Safety Valve	1600x1800x1720/2020			1400x1600	4.9	35	4.950
FÖT.00	Fırın Önü Tezgah Marble top Counter	1400x1000x1000				1.4		680

Kod Code	Gaz Tüketim Değeri Gas Consumption Ng
PLF.D1	1,72 m ³ /h
PLF.D2	2,11 m ³ /h
PLF.D4	2,27 m ³ /h
PLF.D5	2,35 m ³ /h

Türkçe

PİDE VE LAHMACUN
FIRINLARI (VENTİLLİ)

- Doğalgaz ile çalışan pide ve lahmacun fırınlarında ; magnet emniyet ventilli musluklar.
- 180° C -200° C sıcaklığında çalışabilme.
- İç kısımda 300 mm x 300 mm x 35 mm ateş tuğlası.
- Alt kısım galvanizli sactır.
- Üst kısım tamamen izolasyonludur.
- İstenilen renkte seramik dış kaplama

English

PITTA AND TURKISH PIZZA OVENS
(WITH VALVE)

- Magnet safety valves on Ng operated ovens.
- Working temperature: 180° C -200° C .
- 300 mm x 300 mm x 35 mm firebrick coated into the oven.
- Galvanised sheet at the bottom of oven.
- Pearlitized rock wool isolation at the top of oven.
- Exterior area made by glazed tile and colour may change according to demand.

Gold Midi ve Maxi Pizza Fırınları (Elektrikli)
Gold Midi and Maxi Pizza Ovens (Electrical)

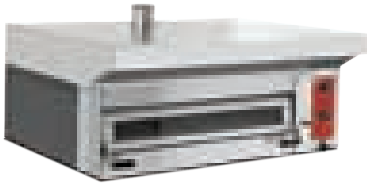
Gold Midi - Maxi Pizza Fırınları - Tek Kat / Gold Midi - Maxi Pizza Ovens - Single Layer

Kod Code	Ürün Adı Description	Ebatlar Dimension mm			İç Ebatlar Interior Dimensions mm	Ağırlık Weight kg	Net Net m³	Güç Power kw	Kapasite Capacity	Fiyatı Price Euro
		a	b	c						
EMP.GF.01-S	Gold Midi Pizza Fırını - Tek Kat Gold Midi Pizza Oven - Single Layer	1050x990x560			700x700x164	75	0.40	7.5	Ø 340 mmx4 Pizza	1.600
EMP.GF.02-S	Gold Maxi Pizza Fırını - Tek Kat Gold Maxi Pizza Oven - Single Layer	1490x1090x560			1055x700x164	150	0.50	10	Ø 340 mmx6 Pizza	1.900

Gold Midi - Maxi Pizza Fırınları - İki Kat / Gold Midi - Maxi Pizza Ovens - Double Layer

Kod Code	Ürün Adı Description	Ebatlar Dimension mm			İç Ebatlar Interior Dimensions mm	Ağırlık Weight kg	Net Net m³	Güç Power kw	Kapasite Capacity	Fiyatı Price Euro
		a	b	c						
EMP.GF.01-D	Gold Midi Pizza Fırını - İki Kat Gold Midi Pizza Oven - Double Layer	1050x990x930			700x700x164	150	0.90	15	Ø 340 mmx4+4 Pizza	3.300
EMP.GF.02-D	Gold Maxi Pizza Fırını - İki Kat Gold Maxi Pizza Oven - Double Layer	1490x1090x930			1055x700x164	300	1.50	20	Ø 340 mmx6+6 Pizza	3.900

Gold Midi - Maxi Pizza Fırınları - Alt Stand / Gold Midi - Maxi Pizza Ovens - Bottom Stand

Kod Code	Ürün Adı Description	Ebatlar Dimension mm			Ağırlık Weight kg	Net Net m³	Fiyatı Price Euro
		a	b	c			
EMP.GS.01	Gold Midi Pizza Fırını - Alt Standı Gold Midi Pizza Oven - Bottom Stand	1050x900x900			70	0.85	630
EMP.GF.02	Gold Maxi Pizza Fırını - Alt Standı Gold Maxi Pizza Oven - Bottom Stand	1490x1000x900			90	1.34	850

Türkçe
GOLD MİDİ PİZZA FIRINLARI

- 7.5,15 Kw / 3 Ph. 380 V güç.
- Dijital iç sıcaklık göstergesi.
- 400° C maksimum sıcaklık.
- Ayarlanabilir üst ve alt ısı dereceleri.
- Eşit ısı dağılımı.
- Dijital termostat.
- Refraktör pişirme taşı.
- Ø 340 mm'lik 4 pizza kapasitesi.

GOLD MAXİ PİZZA FIRINLARI

- 10,20 Kw / 3 Ph. 380 V güç.
- 400° C maksimum sıcaklık.
- Ayarlanabilir üst ve alt ısı dereceleri.
- Eşit ısı dağılımı.
- Dijital termostat.
- Refraktör pişirme taşı.
- Ø 340 mm'lik 6 pizza kapasitesi.

English
GOLD MİDİ PİZZA OVENS

- 7.5,15 Kw / 3 Ph. 380 V power.
- Digital interior temperature indicator.
- Max temperature:400° C
- Adjustable top and bottom heating degree for each layer.
- Homogenous heat distribution.
- Digital thermostat.
- Baking bedplate made by refractory material.
- Pizza capacity: 4 pieces of Ø 340 mm

GOLD MAXİ PİZZA OVENS

- 10,20 Kw / 3 Ph. 380 V power.
- Max temperature:400° C
- Adjustable top and bottom heating degree for each layer
- Homogenous heat distribution
- Digital thermostat.
- Baking bedplate made by refractory material.
- Pizza capacity: 6 pieces of Ø 340 mm

Pizza Fırınları-Tek Katlı
Single Layer Pizza Ovens

Kod Code	Ürün Adı Description	Ebatlar Dimension mm			İç Ebatlar Interior Dimensions mm	Ağırlık Weight kg	Net Net m³	Güç Power kw	Kapasite Capacity	Fiyatı Price Euro
		a	b	c						
EMP.4	Pizza Fırını Pizza Oven	825x710x390			525x525x145	56	0,23	5.4	Ø 250 mmx4 Pizza	770
EMP.5	Pizza Fırını Pizza Oven	890x810x435			620x620x174	67	0.31	5.7	Ø 300 mmx4 Pizza	890
EMP.6	Pizza Fırını Pizza Oven	1190x810x435			920x620x174	102	0.41	7.5	Ø 300 mmx5 Pizza	1.155
EMP.9	Pizza Fırını Pizza Oven	1190x1100x435			920x920x174	120	0.78	15	Ø 300 mmx9 Pizza	1.550
EMP.AS.4	Alt Stand Bottom Stand	825x610x850				18	0.43			250
EMP.AS.5	Alt Stand Bottom Stand	890x730x850				21	0.55			270
EMP.AS.6	Alt Stand Bottom Stand	1190x730x850				26	0.74			315
EMP.AS.9	Alt Stand Bottom Stand	1250x1120x850				32	1.17			420

Kod Code	Elektrik Girişi Electric Input v	Kablo Kesiti Cable Cross Section mm²
EMP.4	380	5x2.5
EMP.5	380	5x2.5
EMP.6	380	5x2.5
EMP.9	380	5x4



Türkçe

4'LÜ PİZZA FIRINLARI

- 5.4 Kw / 3 Ph. 380 V güç.
- Ayarlanabilir üst ve alt ısı verimleri.
- Refraktör pişirme taşı.
- Ø 250 mm 4 pizza kapasitesi.

5'Lİ PİZZA FIRINLARI

- 5.7 Kw / 3 Ph. 380 V güç.
- Ayarlanabilir üst ve alt ısı verimleri.
- Refraktör pişirme taşı.
- Ø 300 mm x 4 pizza kapasitesi.

6'Lİ PİZZA FIRINLARI

- 7.5 Kw / 3 Ph. 380 V güç.
- Ayarlanabilir üst ve alt ısı verimleri.
- Refraktör pişirme taşı.
- Ø 300 mm x 5 pizza kapasitesi.

9'LU PİZZA FIRINLARI

- 15 Kw / 3 Ph. 380 V güç.
- Ayarlanabilir üst ve alt ısı verimleri.
- Refraktör pişirme taşı.
- Ø 300 mm x 9 Pizza kapasitesi.

English

PIZZA OVENS-4

- 5.4 Kw / 3 Ph. 380 V power.
- Adjustable top and bottom heating output.
- Baking bedplate made by refractory material.
- Pizza capacity: 4 pieces of Ø 250 mm

PIZZA OVENS-5

- 5.7 Kw / 3 Ph. 380 V power.
- Adjustable top and bottom heating output.
- Baking bedplate made by refractory material.
- Pizza capacity : 4 pieces of Ø 300 mm

PIZZA OVENS-6

- 7.5 Kw / 3 Ph. 380 V power.
- Adjustable top and bottom heating output.
- Baking bedplate made by refractory material.
- Pizza capacity : 5 pieces of Ø 300 mm

PIZZA OVENS-9

- 15 Kw / 3 Ph. 380 V power.
- Adjustable top and bottom heating output.
- Baking bedplate made by refractory material.
- Pizza capacity : 9 pieces of Ø 300 mm

Pizza Fırınları-Çift Katlı
Two Layer Pizza Ovens

Kod Code	Ürün Adı Description	Ebatlar Dimension mm			İç Ebatlar Interior Dimensions mm	Ağırlık Weight kg	Net Net m ²	Güç Power kw	Kapasite Capacity	Fiyatı Price Euro
		a	b	c						
EMP.4+4	Pizza Fırını Pizza Oven	825	710	670	525x525x145	95	0.40	10.9	Ø 250 mm x 4+4 Pizza	1.260
EMP.5+5	Pizza Fırını Pizza Oven	890	810	760	620x620x174	115	0.53	11.4	Ø 300 mm x 4+4 Pizza	1.470
EMP.6+6	Pizza Fırını Pizza Oven	1190	810	760	920x620x174	170	0.70	15	Ø 300 mm x 5+5 Pizza	2.100
EMP.9+9	Pizza Fırını Pizza Oven	1190	1110	760	920x920x174	220	1.25	30	Ø 300 mm x 9+9 Pizza	2.595
EMP.AS.4	Alt Stand Bottom Stand	825	610	850		18	0.43			250
EMP.AS.5	Alt Stand Bottom Stand	890	730	850		21	0.55			270
EMP.AS.6	Alt Stand Bottom Stand	1190	730	850		26	0.74			315
EMP.AS.9	Alt Stand Bottom Stand	1250	1120	850		32	1.19			420

Türkçe
4+4 PIZZA FIRINLARI

- 10.9 Kw / 3 Ph. 380 V güç.
- Her bir fırın için, ayarlanabilir üst ve alt ısı dereceleri.
- Refraktör pişirme taşı.
- Ø 250 mm 8 pizza kapasitesi.

5+5 PIZZA FIRINLARI

- 11.4 Kw / 3 Ph. 380 V güç.
- Her bir fırın için, ayarlanabilir üst ve alt ısı dereceleri.
- Refraktör pişirme taşı.
- Ø 300 mm x 8 pizza kapasitesi.

6+6 PIZZA FIRINLARI

- 15 KW / 3 Ph. 380 V güç.
- Her bir fırın için, ayarlanabilir üst ve alt ısı dereceleri.
- Refraktör pişirme taşı.
- Ø 300 mm x 10 Pizza kapasitesi.

9+9 PIZZA FIRINLARI

- 30 KW / 3 Ph. 380 V güç.
- Her bir fırın için, ayarlanabilir üst ve alt ısı dereceleri.
- Refraktör pişirme taşı.
- Ø 300 mm x 18 Pizza kapasitesi.

English
PIZZA OVENS-4+4

- 10.9 KW / 3 Ph. 380 V power.
- Adjustable top and bottom heating degree for each oven.
- Baking bedplate made by refractory material.
- Pizza capacity: 8 pieces of Ø 250 mm

PIZZA OVENS-5+5

- 11.4 KW / 3 Ph. 380 V power.
- Adjustable top and bottom heating degree for each oven.
- Baking bedplate made by refractory material.
- Pizza capacity : 8 pieces of Ø 300 mm

PIZZA OVENS-6+6

- 15 KW / 3 Ph. 380 V power.
- Adjustable top and bottom heating degree for each oven.
- Baking bedplate made by refractory material.
- Pizza capacity : 10 pieces of Ø 300 mm

PIZZA OVENS-9+9

- 30 KW / 3 Ph. 380 V power.
- Adjustable top and bottom heating degree for each oven.
- Baking bedplate made by refractory material.
- Pizza capacity : 18 pieces of Ø 300 mm

Kod Code	Elektrik Girişi Electric Input V	Kablo Kesiti Cable Cross Section mm ²
EMP.4+4	380	5x2.5
EMP.5+5	380	5x2.5
EMP.6+6	380	5x2.5
EMP.9+9	380	5x6

Pizza Fırınları (Gazlı)
Pizza Ovens (Gas)



EMP.4G

EMP.4+4G

Kod Code	Ürün Adı Description	Ebatlar Dimension mm			İç Ebatlar Interior Dimensions mm	Ağırlık Weight kg	Net Net m ³	Güç Power kw	Kapasite Capacity	Fiyatı Price Euro
		a	b	c						
EMP.4G	Pizza Fırını - Gazlı Pizza Oven - Gas	1100x950x520			615x615x150	125	0,54	16.10	Ø 300 mmx4 Pizza	1.680
EMP.4+4G	Pizza Fırını - Gazlı Pizza Oven - Gas	1100x950x1040			615x615x150	250	1.08	32.20	Ø 300 mmx4+4 Pizza	3.360
EMP.6G	Pizza Fırını - Gazlı Pizza Oven - Gas	1400x950x520			915x615x150	161	0.69	16.2	Ø 300 mmx6 Pizza	2.000
EMP.6+6G	Pizza Fırını - Gazlı Pizza Oven - Gas	1400x950x1040			915x615x150	322	1.38	32.2	Ø 300 mmx6+6 Pizza	4.000
EMP.9G	Pizza Fırını - Gazlı Pizza Oven - Gas	1400x1250x520			915x915x150	200	0.91	22	Ø 300 mmx9 Pizza	2.400
EMP.9+9G	Pizza Fırını - Gazlı Pizza Oven - Gas	1400x1250x1040			915x915x150	400	1.82	48	Ø 300 mmx9+9 Pizza	4.800
EMP.4G-S	Alt Stand Bottom Stand	910x865x850				22	0.67			315
EMP.6G-S	Alt Stand Bottom Stand	1210x865x850				36	0.89			370
EMP.9G-S	Alt Stand Bottom Stand	1210x1165x850				34	1.2			420

Kod Code	Gaz Tüketim Değeri Gas Consumption Ng	Gaz Tüketim Değeri Gas Consumption Lpg
EMP.4G	1,70 m ³ /h	1,21 kg/h
EMP.6G	2,30 m ³ /h	1,21 kg/h
EMP.9G	2,30 m ³ /h	1,9 kg/h
EMP.4+4G	2,40 m ³ /h	2,42 kg/h
EMP.6+6G	4,60 m ³ /h	2,42 kg/h
EMP.9+9G	5,07 m ³ /h	3,80 kg/h

Türkçe

4'LÜ PİZZA FIRINLARI

- LPG ve Ng ile çalışabilme özelliği.
- Magnet emniyet ventilli musluklar.
- Dijital iç sıcaklık göstergesi.
- İç sıcaklık göstergesi ile dijital termostat kontrolü.
- 2 veya daha fazla kat yapmaya imkan sağlayan modüler sistem.
- Elektronik ateşleme sistemi.
- Sürekli alev denetimi.
- Refraktör pişirme taşı.
- Ø 300 mm'lik 4 pizza kapasitesi.

6'LI PİZZA FIRINLARI

- LPG ve Ng ile çalışabilme özelliği.
- Magnet emniyet ventilli musluklar.
- Dijital iç sıcaklık göstergesi.
- İç sıcaklık göstergesi ile dijital termostat kontrolü.
- 2 veya daha fazla kat yapmaya imkan sağlayan modüler sistem.
- Elektronik ateşleme sistemi.
- Sürekli alev denetimi.
- Refraktör pişirme taşı.
- Ø 300 mm'lik 6 pizza kapasitesi.

9'LU PİZZA FIRINLARI

- LPG ve Ng ile çalışabilme özelliği.
- Magnet emniyet ventilli musluklar.
- Dijital iç sıcaklık göstergesi.
- İç sıcaklık göstergesi ile dijital termostat kontrolü.
- 2 veya daha fazla kat yapmaya imkan sağlayan modüler sistem.
- Elektronik ateşleme sistemi.
- Sürekli alev denetimi.
- Refraktör pişirme taşı.
- Ø 300 mm'lik 9 pizza kapasitesi.

English

PIZZA OVENS-4

- Adaptable to LPG or Ng.
- Magnet safety valves.
- Digital interior temperature indicator.
- Modular deck system, pizza oven can be available with 2 or more decks.
- Electronic burner ignition.
- Constant flame control.
- Baking bedplate made by refractory material.
- Pizza capacity: 4 pieces of Ø 300 mm

PIZZA OVENS-6

- Adaptable to LPG or Ng.
- Magnet safety valves.
- Digital interior temperature indicator.
- Digital thermostat control by the interior temperature indicator.
- Modular deck system, pizza oven can be available with 2 or more decks.
- Electronic burner ignition.
- Constant flame control.
- Baking bedplate made by refractory material.
- Pizza capacity: 6 pieces of Ø 300 mm

PIZZA OVENS-9

- Adaptable to LPG or Ng.
- Magnet safety valves.
- Digital interior temperature indicator.
- Digital thermostat control by the interior temperature indicator.
- Modular deck system, pizza oven can be available with 2 or more decks.
- Electronic burner ignition.
- Constant flame control.
- Baking bedplate made by refractory material.
- Pizza capacity: 9 pieces of Ø 300 mm



Fırınlar (Pide ve Lahmacun)
Ovens (Classic)

* Pasta Börek Fırınları (Gazlı) / Pastry Ovens (Gas)

* Börek Pişirme Ocağı / Pastry Cooker

Pasta Börek Fırınları (Gazlı)
Pastry Ovens (Gas)



Kod Code	Ürün Adı Description	Ebatlar Dimension mm			Net Net m ³	Güç Power kw	Kapasite Capacity Izgara Raf / Rack Shelf	Fiyatı Price Euro
		a	b	c				
PBF.D1	Pasta Börek Fırını NG (Emniyet Ventilli) Pastry Oven NG (With Safety Valve)	970x920x1700			1.5	18.78	5 Sıra	1.700

Kod Code	Gaz Tüketim Değeri Gas Consumption Ng	Gaz Tüketim Değeri Gas Consumption Lpg
PBF.D1	1,98 m ³ /h	

Türkçe

PASTA BÖREK FIRINLARI

- LPG ve Ng ile çalışabilme özelliği.
- Doğalgaz ile çalışan pasta börek fırınlarında ; magnet emniyet ventilli musluklar.
- Paslanmaz çelik gövde.

English

PASTRY OVENS

- Adaptable to LPG or Ng.
- Magnet safety valves provide security on Ng operated ovens.
- Stainless steel body.

Börek Pişirme Ocağı
Pastry Cooker

BP.01



BP.03



Kod Code	Ürün Adı Description	Ebatlar Dimension mm			Net Net m³	Güç Power kw	Fiyatı Price Euro
		a	b	c			
BP.01	Börek Pişirme Ocağı - Taban Rafı Pastry Cooker - Bottom Shelf	700x700x850			0.4	9.5	1.330
BP.02	Börek Pişirme Ocağı - Paslanmaz Çelik Kaplı Pastry Cooker - Stainless Steel Covered	700x700x850			0.4	9.5	1.785
BP.03	Börek Pişirme Ocağı - Ahşap Kaplı Pastry Cooker - Wooden Decorated	700x700x850			0.4	9.5	1.950

Türkçe

BÖREK PİŞİRME OCAĞI

- LPG ve NG ile çalışabilme özelliği.
- Magnet emniyet ventilli musluklar.
- Dönen üst pişirici.
- 60 cm çapında tepsi haznesi.
- Paslanmaz çelik gövde.

English

PASTRY COOKER

- Adaptable to LPG or Ng
- Magnet safety valves provide security on Ng operated ovens.
- Rotating top.
- Tray reservoir capacity: 60 cm.
- Stainless steel body.





Sogutma ❄️
Ekipmanlari
Cooling Equipments



The Magic / Kitchen of Business

empero@empero.com.tr



- * **Tezgah Tipi Buzdolapları (Fanlı) / Refrigerated Counters (Fan Cooling)**
- * **Çekmeceli Tezgah Tipi Buzdolapları (Fanlı) / Refrigerated Counters with Drawer (Fan Cooling)**
- * **Tezgah Tipi Derin Dondurucu (Fanlı Soğutma) / Freezer Counters (Fan Cooling)**
- * **Camlı Tezgah Tipi Buzdolapları / Glass Door Refrigerated Counters**
- * **Evyeli Tezgah Tipi Buzdolapları / Refrigerated Counters With Sink**
- * **Set Altı Buzdolapları (Fanlı Soğutma) / Refrigerated Under Counters (Fan Cooling)**
- * **Pizza ve Salata Hazırlık Buzdolapları / Refrigerated Pizza and Salad Preparation Counters**
- * **Pizza ve Salata Hazırlık Buzdolapları / Refrigerated Pizza and Salad Preparation Counters**
- * **Pizza ve Salata Hazırlık Buzdolapları / Refrigerated Pizza and Salad Preparation Counters**
- * **Set Üstü Saladbarlar / Refrigerated Countertop Saladbars**
- * **Granit Tablalı Hamur Hazırlık Dolapları / Granite Top Refrigerated Counter**
- * **Granit Tablalı Hamur Hazırlık Dolapları / Refrigerated Pizza Preparation Counter with Granite Top**
- * **Dik Tip Buzdolapları (Fanlı) / Refrigerated Cabinets (Fan Cooling)**
- * **Dik Tip Buzdolapları (Fanlı) / Refrigerated Cabinets (Fan Cooling)**
- * **Dik Tip Derin Dondurucu (Fanlı) / Freezer Cabinets (Fan Cooling)**
- * **Dik Tip Buzdolapları (Pastane) / Refrigerated Cabinets (Patisserie)**
- * **Dik Tip Derin Dondurucu (Pastane) / Freezer Cabinets (Patisserie)**
- * **Dik Tip Buzdolapları (Pastane) / Refrigerated Cabinets (Patisserie)**
- * **Dik Tip Derin Dondurucu (Pastane) / Freezer Cabinets (Patisserie)**
- * **Soğuk Oda Depoları (0° C /+8° C) / Cold Room (0° C / +8° C)**
- * **Soğuk Oda Depoları (0° C /+8° C) / Cold Room (0° C / +8° C)**
- * **Soğuk Oda Depoları (0° C /-20° C) / Cold Room (0° C / -20° C)**
- * **Soğuk Oda Depoları (0° C /-20° C) / Cold Room (0° C / -20° C)**
- * **Modüler Soğuk Odalar / Modular Cold Room**

Tezgah Tipi Buzdolapları (Fanlı)
Refrigerated Counters (Fan Cooling)



Kod Code	Ürün Adı Description	Ebatlar Dimension mm			Ağırlık Weight kg	Net Net m³	Güç Power kw	Kapasite Capacity lt	Fiyatı Price Euro
		a	b	c					
EMP.150.60.01	Tezgah Tipi Buzdolabı (İki Kapılı) Refrigerated Counter (Double Doors)	1500	600	850	85	0.8	0.35	250	1.450
EMP.150.70.01	Tezgah Tipi Buzdolabı (İki Kapılı) Refrigerated Counter (Double Doors)	1500	700	850	95	0.9	0.35	300	1.525
EMP.200.60.01	Tezgah Tipi Buzdolabı (Üç Kapılı) Refrigerated Counter (Triple Doors)	2000	600	850	110	1	0.35	400	1.680
EMP.200.70.01	Tezgah Tipi Buzdolabı (Üç Kapılı) Refrigerated Counter (Triple Doors)	2000	700	850	120	1.2	0.35	500	1.785
EMP.255.60.01	Tezgah Tipi Buzdolabı (Dört Kapılı) Refrigerated Counter (Four Doors)	2550	600	850	135	1.3	0.50	550	2.150
EMP.255.70.01	Tezgah Tipi Buzdolabı (Dört Kapılı) Refrigerated Counter (Four Doors)	2550	700	850	145	1.5	0.50	700	2.260

Türkçe

TEZGAH TİPİ BUZDOLAPLARI (FANLI)

- Çalışma aralığı; +0° C, + 5° C (tropikal 43° C)
- 220 V-230 V -1 +N -50 60 Hz elektrik gücü.
- "CFC Free", R-134 A soğutucu gaz.
- 40 kg/m3 yoğunluk.
- Elektronik, sıcaklık ve defrost kontrollü gösterge.
- Defrost esnasında otomatik su buharlaştırma.
- Sökülebilir havalandırmalı kompresör.
- Fanlı soğutma.
- 48 mm kalınlığında "ozon dostu" poliüretan izolasyon.
- 45 derecede sabit kendiliğinden kapanan kapılar.
- Alüminyum panelli,bakır borulu evaporatör.
- Ayarlanabilir , paslanmaz çelik raf yuvaları,plastik kaplama iç raf.
- Paslanmaz çelik gövde.

English

REFRIGERATED COUNTERS (FAN COOLING)

- Working temperature; 0° C, + 5° C (at ambient temp. 43° C)
- 220 V-230 V -1 +N -50 60 Hz electrical power.
- "CFC Free", R-134 A refrigerant gas.
- 40 kg/m3 density.
- Electronic temperature and defrosting control and display.
- Automatic evaporation of water during defrosting.
- Removable, conditioning compressor.
- Cooling with fan.
- "Ozone-friendly" 48 mm thickness polyurethane isolation.
- Self closing doors .
- Copper tube evaporator with aluminum fins.
- Adjustable, stainless steel shelf housing, plastic coated shelves.
- Stainless steel body.

R-290 Soğutucu Gaz Tipi için %3 fiyat farkı ekleyiniz.
Please add %3 price difference for R-290 refrigerant gas.



Çekmeceli Tezgah Tipi Buzdolapları (Fanlı) Refrigerated Counters with Drawer (Fan Cooling)



Kod Code	Ürün Adı Description	Ebatlar Dimension mm			Ağırlık Weight kg	Net Net m³	Güç Power kw	Kapasite Capacity lt	Fiyatı Price Euro
		a	b	c					
EMP.150.70.01-2C	Tezgah Tipi Buzdolabı 2 Çekmece+1 Kapı (Fanlı) Refrigerated Counter, 2 Drawers+1 Door (With Fan)	1500	700	850	95	0.9	0.35	300	1.925
EMP.150.70.01-4C	Tezgah Tipi Buzdolabı 4 Çekmece Refrigerated Counter 4 Drawers	1500	700	850	95	0.9	0.35	300	2.325
EMP.200.70.01-2C	Tezgah Tipi Buzdolabı 2 Çekmece+2 Kapı (Fanlı) Refrigerated Counter, 2 Drawers+2 Doors (With Fan)	2000	700	850	120	1.2	0.35	500	2.180
EMP.200.70.01-4C	Tezgah Tipi Buzdolabı 4 Çekmece+1 Kapı (Fanlı) Refrigerated Counter, 4 Drawers+1 Door (With Fan)	2000	700	850	120	1.2	0.35	500	2.575
EMP.200.70.01-6C	Tezgah Tipi Buzdolabı 6 Çekmece Refrigerated Counter 6 Drawers	2000	700	850	120	1.2	0.35	500	2.975
EMP.255.70.01-2C	Tezgah Tipi Buzdolabı 2 Çekmece + 3 Kapı (Fanlı) Refrigerated Counter, 2 Drawers + 3 Doors (With Fan)	2550	700	850	145	1.5	0.50	700	2.680
EMP.255.70.01-4C	Tezgah Tipi Buzdolabı 4 Çekmece + 2 Kapı (Fanlı) Refrigerated Counter, 4 Drawers + 2 Doors (With Fan)	2550	700	850	145	1.5	0.50	700	3.100
EMP.255.70.01-6C	Tezgah Tipi Buzdolabı 6 Çekmece + 1 Kapı (Fanlı) Refrigerated Counter, 6 Drawers + 1 Door (With Fan)	2550	700	850	145	1.5	0.50	700	3.400
EMP.255.70.01-8C	Tezgah Tipi Buzdolabı 8 Çekmece Refrigerated Counter 8 Drawers	2550	700	850	145	1.5	0.50	700	3.800

Türkçe

ÇEKMECELİ TEZGAH TİPİ BUZDOLAPLARI (FANLI)

- GN 1/1 1500 mm kapasiteli çekmeceler.
- Çalışma aralığı; +0 °C , + 5 °C (tropikal 43° C)
- 220 V-230 V -1 +N -50 60 Hz elektrik gücü.
- "CFC Free" , R-134 A soğutucu gaz.
- 40 kg/m3 yoğunluk.
- Elektronik, sıcaklık ve defrost kontrollü gösterge.
- Defrost esnasında otomatik su buharlaştırma.
- Sökülebilir havalandırmalı kompresör.
- Fanlı soğutma.
- 48 mm kalınlığında "ozon dostu" poliüretan izolasyon.
- 45 derecede sabit kendiliğinden kapanan kapılar.
- Alüminyum paneli,bakır borulu evaporatör.
- Paslanmaz çelik gövde.

English

REFRIGERATED COUNTERS WITH DRAWER (FAN COOLING)

- Drawer capacity : GN 1/1 1500 mm.
- Working temperature; 0° C , + 5° C (at ambient temp. 43° C)
- 220 V-230 V -1 +N -50 60 Hz electrical power.
- "CFC Free" , R-134 A refrigerant gas.
- 40 kg/m3 density.
- Electronic temperature and defrosting control and display.
- Automatic evaporation of water during defrosting.
- Removable,conditioning compressor.
- Fan cooling.
- "Ozone-friendly" 48 mm thickness polyurethane isolation.
- Self closing doors .
- Copper tube evaporator with aluminum fins.
- Stainless steel body.

**R-290 Soğutucu Gaz Tipi için %3 fiyat farkı ekleyiniz.
Please add %3 price difference for R-290 refrigerant gas.**



Tezgah Tipi Derin Dondurucu (Fanlı Soğutma)
Freezer Counters (Fan Cooling)



Kod Code	Ürün Adı Description	Ebatlar Dimension mm			Ağırlık Weight kg	Net Net m³	Güç Power kw	Kapasite Capacity lt	Fiyatı Price Euro
		a	b	c					
EMP.150.60.02	Tezgah Tipi Derin Dondurucu (İki Kapılı) Freezer Counters (Double Doors)	1500	600	850	95	0.8	1	250	2.150
EMP.150.70.02	Tezgah Tipi Derin Dondurucu (İki Kapılı) Freezer Counters (Double Doors)	1500	700	850	105	0.9	1	300	2.260
EMP.200.60.02	Tezgah Tipi Derin Dondurucu (Üç Kapılı) Freezer Counters (Triple Doors)	2000	600	850	120	1	1	400	2.500
EMP.200.70.02	Tezgah Tipi Derin Dondurucu (Üç Kapılı) Freezer Counters (Triple Doors)	2000	700	850	130	1.2	1	500	2.625
EMP.255.60.02	Tezgah Tipi Derin Dondurucu (Dört Kapılı) Freezer Counters (Four Doors)	2550	600	850	145	1.3	1	550	2.900
EMP.255.70.02	Tezgah Tipi Derin Dondurucu (Dört Kapılı) Freezer Counters (Four Doors)	2550	700	850	155	1.5	1	700	3.200

Türkçe

TEZGAH TİPİ DERİN DONDURUCU
(FANLI SOĞUTMA)

- Derin dondurucu için çalışma aralığı: -18 ° C , -20 ° C .
- 220 V-230 V -1 +N -50 60 Hz elektrik gücü.
- "CFC Free", 404A soğutucu gaz.
- 40 kg/m3 yoğunluk.
- Elektronik, sıcaklık ve defrost kontrollü gösterge.
- Defrost esnasında otomatik su buharlaştırma.
- Sökülebilir havalandırmalı kompresör.
- Fanlı soğutma.
- 48 mm kalınlığında "ozon dostu" poliüretan izolasyon.
- 45 derecede sabit kendiliğinden kapanan kapılar.
- Alüminyum panelli, bakır borulu evaporatör.
- Ayarlanabilir , paslanmaz çelik raf yuvaları, plastik kaplama iç raf.
- Paslanmaz çelik gövde.

English

FREEZER COUNTERS (FAN COOLING)

- Working temperature for freezers: -18° C, -20° C
- 220 V-230 V -1 +N -50 60 Hz electrical power.
- "CFC Free", 404A refrigerant gas.
- 40 kg/m3 density.
- Electronic temperature and defrosting control and display.
- Automatic evaporation of water during defrosting.
- Removable, conditioning compressor.
- Fan cooling.
- "Ozone-friendly" 48 mm thickness polyurethane isolation.
- Self closing doors.
- Copper tube evaporator with aluminum fins.
- Adjustable, stainless steel shelf housing, plastic coated shelves.
- Stainless steel body.

R-290 Soğutucu Gaz Tipi için %3 fiyat farkı ekleyiniz.
Please add %3 price difference for R-290 refrigerant gas.



Camlı Tezgah Tipi Buzdolapları Glass Door Refrigerated Counters



Kod Code	Ürün Adı Description	Ebatlar Dimension mm			Ağırlık Weight kg	Net Net m³	Güç Power kw	Kapasite Capacity lt	Fiyatı Price Euro
		a	b	c					
EMP.150.60.03	Camlı Tezgah Tipi Buzdolabı (İki Kapılı) Glass Door Refrigerated Counter (Double Doors)	1500x600x850			90	0.8	0.35	250	1.575
EMP.150.70.03	Camlı Tezgah Tipi Buzdolabı (İki Kapılı) Glass Door Refrigerated Counter (Double Doors)	1500x700x850			95	0.9	0.35	300	1.665
EMP.200.60.03	Camlı Tezgah Tipi Buzdolabı (Üç Kapılı) Glass Door Refrigerated Counter (Triple Doors)	2000x600x850			115	1	0.35	400	1.900
EMP.200.70.03	Camlı Tezgah Tipi Buzdolabı (Üç Kapılı) Glass Door Refrigerated Counter (Triple Doors)	2000x700x850			125	1.2	0.35	500	2.000
EMP.255.60.03	Camlı Tezgah Tipi Buzdolabı (Dört Kapılı) Glass Door Refrigerated Counter (Four Doors)	2550x600x850			145	1.3	0.50	550	2.400
EMP.255.70.03	Camlı Tezgah Tipi Buzdolabı (Dört Kapılı) Glass Door Refrigerated Counter (Four Doors)	2550x700x850			155	1.5	0.50	700	2.500

Türkçe

CAMLIL TEZGAH TİPİ BUZDOLAPLARI

- Çalışma aralığı; 0° C , + 5° C (tropikal 43° C)
- 220 V-230 V -1 +N -50 60 Hz elektrik gücü.
- "CFC Free" , R-134 A soğutucu gaz.
- 40 kg/m³ yoğunluk.
- Elektronik, sıcaklık ve defrost kontrollü gösterge.
- Defrost esnasında otomatik su buharlaştırma.
- Sökülebilir havalandırılmalı kompresör.
- Fanlı soğutma.
- 48 mm kalınlığında "ozon dostu" poliüretan izolasyon.
- 45 derecede sabit kendiliğinden kapanan kapılar.
- Alüminyum panelli, bakır borulu evaporatör.
- Ayarlanabilir , paslanmaz çelik raf yuvaları, plastik kaplama iç raf.
- Paslanmaz çelik gövde.

English

GLASS DOOR REFRIGERATED COUNTERS

- Working temperature; 0° C , + 5° C (at ambient temp.43° C)
- 220 V-230 V -1 +N -50 60 Hz electrical power.
- "CFC Free" , R-134 A refrigerant gas.
- 40 kg/m³ density.
- Electronic temperature and defrosting control and display.
- Automatic evaporation of water during defrosting.
- Removable, conditioning compressor.
- Fan cooling.
- "Ozone-friendly" 48 mm thickness polyurethane isolation.
- Self closing doors.
- Copper tube evaporator with aluminum fins.
- Adjustable, stainless steel shelf housing, plastic coated shelves.
- Stainless steel body.

**R-290 Soğutucu Gaz Tipi için %3 fiyat farkı ekleyiniz.
Please add %3 price difference for R-290 refrigerant gas.**

Evyeli Tezgah Tipi Buzdolapları
Refrigerated Counters With Sink



Kod Code	Ürün Adı Description	Ebatlar Dimension mm			Ağırlık Weight kg	Net Net m³	Güç Power kw	Kapasite Capacity lt	Evyeye Ölçüleri Sink Dimension mm	Fiyatı Price Euro
		a	b	c						
EMP.150.70.01-EV	Evyeli Tezgah Tipi Buzdolabı (İki Kapılı) Refrigerated Counter With Sink (Double Doors)	1500	700	850	95	0.9	0.35	300	350x400	1.850
EMP.200.70.01-EV	Evyeli Tezgah Tipi Buzdolabı (Üç Kapılı) Refrigerated Counter With Sink (Triple Doors)	2000	700	850	120	1.2	0.35	500	350x400	2.075
EMP.255.70.01-EV	Evyeli Tezgah Tipi Buzdolabı (Dört Kapılı) Refrigerated Counter With Sink (Four Doors)	2550	700	850	145	1.5	0.50	700	350x400	2.675

Türkçe

EVYELİ TEZGAH TİPİ BUZDOLAPLARI

- Çalışma aralığı; +0 ° C , + 5 ° C (tropikal 43° C)
- 220 V-230 V -1 +N -50 60 Hz elektrik gücü.
- "CFC Free" , R-134 A soğutucu gaz.
- 40 kg/m3 yoğunluk.
- Elektronik, sıcaklık ve defrost kontrollü gösterge.
- Defrost esnasında otomatik su buharlaştırma.
- Sökülebilir havalandırılmalı kompresör.
- Fanlı soğutma.
- 48 mm kalınlığında "ozon dostu" poliüretan izolasyon.
- 45 derecede sabit kendiliğinden kapanan kapılar.
- Düz üst tabla önü.
- Alüminyum panelli, bakır borulu evaporatör.
- Ayarlanabilir , paslanmaz çelik raf yuvaları, plastik kaplama iç raf.
- Paslanmaz çelik gövde.

English

REFRIGERATED COUNTERS WITH SINK

- Working temperature; 0° C , + 5° C (at ambient temp. 43° C)
- 220 V-230 V -1 +N -50 60 Hz electrical power.
- "CFC Free" , R-134 A refrigerant gas.
- 40 kg/m3 density.
- Electronic temperature and defrosting control and display.
- Automatic evaporation of water during defrosting.
- Removable, conditioning compressor.
- Fan cooling.
- "Ozone-friendly" 48 mm thickness polyurethane isolation.
- Self closing doors.
- Smooth front top edges.
- Copper tube evaporator with aluminum fins.
- Adjustable, stainless steel shelf housing, plastic coated shelves.
- Stainless steel body.

**R-290 Soğutucu Gaz Tipi için %3 fiyat farkı ekleyiniz.
Please add %3 price difference for R-290 refrigerant gas.**



Set Altı Buzdolapları (Fanlı Soğutma) Refrigerated Under Counters (Fan Cooling)



Kod Code	Ürün Adı Description	Ebatlar Dimension mm			Ağırlık Weight kg	Net Net m³	Güç Power kw	Kapasite Capacity Gn / Container	Fiyatı Price Euro
		a	b	c					
EMP.160.60.01-S	Set Altı Buzdolapları Refrigerated Under Counter	1600	600	550	95	0.5	0.35	4x2/3 100	1.815
EMP.200.60.01-S	Set Altı Buzdolapları Refrigerated Under Counter	2000	600	550	110	0.6	0.35	6x2/3 100	2.060
EMP.160.70.01-S	Set Altı Buzdolapları Refrigerated Under Counter	1600	700	550	90	0.6	0.35	4x1/1 100	1.925
EMP.200.70.01-S	Set Altı Buzdolapları Refrigerated Under Counter	2000	700	550	120	0.8	0.35	6x1/1 100	2.180

Türkçe

SET ALTI BUZDOLAPLARI

- Çalışma aralığı; +0 ° C , + 5° C (tropikal 43° C)
- 220 V-230 V -1 +N -50 60 Hz elektrik gücü.
- "CFC Free", R-134 A, soğutucu gaz.
- 40 kg/m3 yoğunluk.
- Elektronik, sıcaklık ve defrost kontrollü gösterge.
- Defrost esnasında sökülebilir havalandırmalı kompresör.
- Fanlı soğutma.
- 48 mm kalınlığında "ozon dostu" poliüretan izolasyon.
- Düz üst tabla.
- Alüminyum panelli, bakır borulu evaporatör.
- Paslanmaz çelik gövde.

English

REFRIGERATED UNDER COUNTERS

- Working temperature; 0° C , + 5° C (at ambient temp. 43° C)
- 220 V-230 V -1 +N -50 60 Hz electrical power.
- "CFC Free", R-134 A gas.
- 40 kg/m3 density.
- Electronic temperature and defrosting control and display.
- Automatic evaporation of water during defrosting.
- Removable, conditioning compressor.
- Fan Cooling.
- "Ozone-friendly" 48 mm thickness polyurethane isolation.
- Smooth front top edges.
- Copper tube evaporator with aluminum fins.
- Stainless steel body.

R-290 Soğutucu Gaz Tipi için %3 fiyat farkı ekleyiniz.
Please add %3 price difference for R-290 refrigerant gas.



Pizza ve Salata Hazırlık Buzdolapları
Refrigerated Pizza and Salad Preparation Counters



Kod Code	Ürün Adı Description	Ebatlar Dimension mm			Ağırlık Weight kg	Net Net m ³	Güç Power kw	Kapasite Capacity lt	Fiyatı Price Euro
		a	b	c					
EMP.150.70.01-PS	Pizza ve Salata Hazırlık Buzdolapları (İki Kapılı) Refrigerated Pizza and Salad Preparation Counter (Double Doors)	1500x700x850/1050			110	0.9	0.35	300	2.000
EMP.200.70.01-PS	Pizza ve Salata Hazırlık Buzdolapları (Üç Kapılı) Refrigerated Pizza and Salad Preparation Counter (Triple Doors)	2000x700x850/1050			135	1.2	0.35	500	2.525

Türkçe

PİZZA VE SALATA HAZIRLIK BUZDOLAPLARI

- 1500 mm'de 1/4-100 8 adet GN.küvet kapasiteli.
- 2000 mm'de 1/4-100 10 adet GN.küvet kapasiteli.
- Çalışma aralığı; +0 ° C , + 5° C (tropikal 43° C)
- 220 V-230 V -1 +N -50 60 Hz elektrik gücü.
- "CFC Free" , R-134 A soğutucu gaz.
- 40 kg/m3 yoğunluk.
- Elektronik, sıcaklık ve defrost kontrollü gösterge.
- Defrost esnasında otomatik su buharlaştırma.
- Sökülebilir havalandırmalı kompresör.
- Fanlı soğutma.
- 48 mm kalınlığında "ozon dostu" poliüretan izolasyon.
- 45 derecede sabit kendiliğinden kapanan kapılar.
- Yuvarlanmış üst tabla önü.
- Alüminyum panelli,bakır borulu evaporatör.
- Paslanmaz çelik gövde.

*Standart üretimimizde küvet bulunmamaktadır.
*GN küvet haznesi kapalı statik soğutmalıdır.

**R-290 Soğutucu Gaz Tipi için %3 fiyat farkı ekleyiniz.
Please add %3 price difference for R-290 refrigerant gas.**

English

REFRIGERATED PIZZA AND SALAD PREPARATION COUNTERS

- Capacity for 2 door refrigerator : 8 pieces of 1/4-100 gastronom container.
- Capacity for 3 door refrigerator:10 pieces 1/4-100 gastronom container.
- Working temperature; 0° C , + 5° C (at ambient temp.43° C)
- 220 V-230 V -1 +N -50 60 Hz electrical power.
- "CFC Free" , R-134 A refrigerant gas.
- 40 kg/m3 density.
- Electronic temperature and defrosting control and display.
- Automatic evaporation of water during defrosting.
- Removable,conditioning compressor.
- Fan cooling.
- "Ozone-friendly" 48 mm thickness polyurethane isolation.
- Self closing doors.
- Rounded front top edges.
- Copper tube evaporator with aluminum fins.
- Stainless steel body.

*Standart product does not have containers.
*GN container tank covered by static cooling.



Pizza ve Salata Hazırlık Buzdolapları Refrigerated Pizza and Salad Preparation Counters



Kod Code	Ürün Adı Description	Ebatlar Dimension mm			Ağırlık Weight kg	Net Net m³	Güç Power kw	Kapasite Capacity lt	Fiyatı Price Euro
		a	b	c					
EMP.150.70.01-PSO	Pizza ve Salata Hazırlık Buzdolapları (İki Kapılı) Refrigerated Pizza and Salad Preparation Counter (Double Doors)	1500	700	850	110	0.9	0.45	300	1.900
EMP.200.70.01-PSO	Pizza ve Salata Hazırlık Buzdolapları (Üç Kapılı) Refrigerated Pizza and Salad Preparation Counter (Triple Doors)	2000	700	850	135	1.2	0.45	500	2.450

Türkçe

PİZZA VE SALATA HAZIRLIK BUZDOLAPLARI

- 1500 mm'de 1/4-100 6 adet GN.küvet kapasiteli.
- 2000 mm'de 1/4-100 8 adet GN.küvet kapasiteli.
- Çalışma aralığı; +0 ° C , + 5° C (tropikal 43° C)
- 220 V-230 V -1 +N -50 60 Hz elektrik gücü.
- "CFC Free" , 404 A soğutucu gaz.
- 40 kg/m3 yoğunluk.
- Elektronik, sıcaklık ve defrost kontrollü gösterge.
- Defrost esnasında otomatik su buharlaştırma.
- Sökülebilir havalandırmalı kompresör.
- Fanlı soğutma.
- 48 mm kalınlığında "ozon dostu" poliüretan izolasyon.
- 45 derecede sabit kendiliğinden kapanan kapılar.
- Alüminyum panelli,bakır borulu evaporatör.
- Ayarlanabilir , paslanmaz çelik raf yuvaları,plastik kaplama iç raf.
- Paslanmaz çelik gövde.

*Standart üretimimizde küvet bulunmamaktadır.
*GN küvet haznesi kapalı statik soğutmalıdır.

English

REFRIGERATED PIZZA AND SALAD PREPARATION COUNTERS

- Capacity for 2 door refrigerator : 6 pieces of 1/4-100 gastronom container.
- Capacity for 3 door refrigerator: 8 pieces 1/4-100 gastronom container.
- Working temperature; 0° C , + 5° C (at ambient temp.43° C)
- 220 V-230 V -1 +N -50 60 Hz electrical power.
- "CFC Free" , 404 A refrigerant gas.
- 40 kg/m3 density.
- Electronic temperature and defrosting control and display.
- Automatic evaporation of water during defrosting.
- Removable,conditioning compressor.
- Fan cooling.
- "Ozone-friendly" 48 mm thickness polyurethane isolation.
- Self closing doors.
- Copper tube evaporator with aluminum fins.
- Adjustable,stainless steel shelf housing,plastic coated shelves.
- Stainless steel body.

*Standart product does not have containers.
*GN container tank covered by static cooling.

**R-290 Soğutucu Gaz Tipi için %3 fiyat farkı ekleyiniz.
Please add %3 price difference for R-290 refrigerant gas.**



Pizza ve Salata Hazırlık Buzdolapları
Refrigerated Pizza and Salad Preparation Counters



EMP.150.80.01-PSYG



EMP.150.80.01-PSY

Kod Code	Ürün Adı Description	Ebatlar Dimension mm			Ağırlık Weight kg	Net Net m³	Güç Power kw	Kapasite Capacity lt	Fiyatı Price Euro
		a	b	c					
EMP.150.80.01-PSY	Pizza ve Salata Hazırlık Buzdolapları (İki Kapılı) Pizza and Salad Preparation Refrigerators (Double Doors)	1500	800	850/1350	115	0.9	0.35	300	2.100
EMP.200.80.01-PSY	Pizza ve Salata Hazırlık Buzdolapları (Üç Kapılı) Pizza and Salad Preparation Refrigerators (Triple Doors)	2000	800	850/1350	140	1.2	0.35	500	2.575

Kod Code	Ürün Adı Description	Ebatlar Dimension mm			Ağırlık Weight kg	Net Net m³	Güç Power kw	Kapasite Capacity lt	Fiyatı Price Euro
		a	b	c					
EMP.150.80.01-PSYG	Granitli Pizza ve Salata Hazırlık Buzdolapları (İki Kapılı) Granite Pizza and Salad Preparation Refrigerators (Double Doors)	1500	800	850/1350	115	0.9	0.35	300	2.575
EMP.200.80.01-PSYG	Granitli Pizza ve Salata Hazırlık Buzdolapları (Üç Kapılı) Granite Pizza and Salad Preparation Refrigerators (Triple Doors)	2000	800	850/1350	140	1.2	0.35	500	3.050

Türkçe

PİZZA VE SALATA HAZIRLIK BUZDOLAPLARI

- 1500 mm'de 1/4-100 8 adet GN.küvet kapasiteli.
- 2000 mm'de 1/4-100 11 adet GN.küvet kapasiteli.
- Her kapakta 4 adet 400x600 mm tepsi kapasitesi.
- 2 adet 400x600 mm mayalandırma çekmecesini.
- Çalışma aralığı; +0 ° C , + 5° C (tropikal 43° C)
- 220 V-230 V -1 +N -50 60 Hz elektrik gücü.
- "CFC Free" , R-134 A soğutucu gaz.
- 40 kg/m3 yoğunluk.
- Elektronik, sıcaklık ve defrost kontrollü gösterge.
- Defrost esnasında otomatik su buharlaştırma.
- Sökülebilir havalandırmalı kompresör.
- Fanlı soğutma.
- 48 mm kalınlığında "ozon dostu" poliüretan izolasyon.
- 45 derecede sabit kendiliğinden kapanan kapılar.
- Yuvarlanmış üst tabla önü.
- Alüminyum panelli,bakır borulu evaporatör.
- Paslanmaz çelik gövde.

*Standart üretimimizde küvet bulunmamaktadır.
*GN küvet haznesi kapalı statik soğutulmalıdır.

English

REFRIGERATED PIZZA AND SALAD PREPARATION COUNTERS

- Capacity for 2 door refrigerator : 8 pieces of 1/4-100 gastronom container.
- Capacity for 3 door refrigerator:11 pieces 1/4-100 gastronom container.
- Tray grid capacity: 4 pieces 400x600 mm for each.
- Fermentation drawer capacity: 2 pieces 400x600 mm.
- Working temperature; 0° C , + 5° C (at ambient temp. 43° C)
- 220 V-230 V -1 +N -50 60 Hz electrical power.
- "CFC Free" , R-134 A refrigerant gas.
- 40 kg/m3 density.
- Electronic temperature and defrosting control and display.
- Automatic evaporation of water during defrosting.
- Removable,conditioning compressor.
- Fan cooling.
- "Ozone-friendly" 48 mm thickness polyurethane isolation.
- Self closing doors .
- Rounded front top edges.
- Copper tube evaporator with aluminum fins.
- Stainless steel body.

*Standart product does not have containers.
*GN container tank covered by static cooling.

R-290 Soğutucu Gaz Tipi için %3 fiyat farkı ekleyiniz.
Please add %3 price difference for R-290 refrigerant gas.

Set Üstü Saladbarlar Refrigerated Countertop Saladbars



Kod Code	Ürün Adı Description	Ebatlar Dimension mm			Ağırlık Weight kg	Net Net m³	Güç Power kw	Fiyatı Price Euro
		a	b	c				
EMP.160	Set Üstü Saladbar Refrigerated Countertop Saladbars	1600x350x500			45	0.3	0.2	850
EMP.210	Set Üstü Saladbar Refrigerated Countertop Saladbars	2100x350x500			55	0.4	0.2	950

Türkçe

SET ÜSTÜ SALADBARLAR

- 1600 mm'de 1/4-100 7 adet GN.küvet kapasiteli.
- 2100 mm'de 1/4-100 9 adet GN.küvet kapasiteli.
- Çalışma aralığı; +0 °C , + 5° C (tropikal 43° C).
- 220 V-230 V -1 +N -50 60 Hz elektrik gücü.
- "CFC Free" , R-134 A soğutucu gaz.
- 40 kg/m3 yoğunluk.
- Elektronik, sıcaklık ve defrost kontrollü gösterge.
- Statik soğutma.
- "Ozon dostu" poliüretan izolasyon.
- Alüminyum panelli,bakır borulu evaporatör.
- Paslanmaz çelik gövde.

English

REFRIGERATED COUNTERTOP SALADBAR

- Capacity for 1600 mm : 7 pieces of 1/4-100 gastronom container.
- Capacity for 2100 mm : 9 pieces of 1/4-100 gastronom container.
- Working temperature; 0° C , + 5° C (at ambient temp. 43° C)
- 220 V-230 V -1 +N -50 60 Hz electrical power.
- "CFC Free" , R-134 A refrigerant gas.
- 40 kg/m3 density.
- Electronic temperature and defrosting control and display.
- Static Cooling.
- "Ozone-friendly" polyurethane isolation.
- Copper tube evaporator with aluminum fins.
- Stainless steel body.

*Standart üretimimizde küvet bulunmamaktadır.

*Standart product does not have containers.

**R-290 Soğutucu Gaz Tipi için %3 fiyat farkı ekleyiniz.
Please add %3 price difference for R-290 refrigerant gas.**

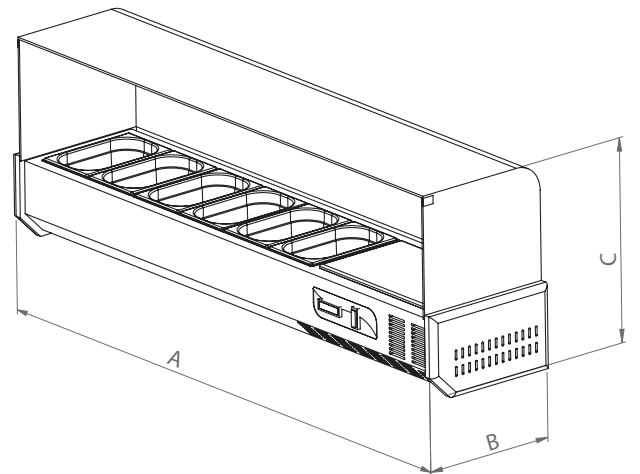

Granit Tablalı Hamur Hazırlık Dolapları Granite Top Refrigerated Counter



Kod Code	Ürün Adı Description	Ebatlar Dimension mm			Ağırlık Weight kg	Net Net m ³	Güç Power kw	Kapasite Capacity lt	Fiyatı Price Euro
		a	b	c					
EMP.160.80.01	Granit Tablalı Hamur Hazırlık Dolapları (İki Kapılı) Granite Top Refrigerated Counter (Double Door)	1600x800x1020			175	1.1	0.35	300	2.400
EMP.210.80.01	Granit Tablalı Hamur Hazırlık Dolapları (Üç Kapılı) Granite Top Refrigerated Counter (Triple Door)	2100x800x1020			220	1.5	0.35	500	2.750

Türkçe

GRANİT TABLALI HAMUR HAZIRLIK DOLAPLARI

- 2 adet 400x600 mm mayalandırma çekmecesini.
- Her kapakta 4 adet 400x600 mm tepsi kapasitesi.
- Çalışma aralığı; +0 ° C , + 5 ° C (tropikal 43° C)
- 220 V-230 V -1 +N -50 60 Hz elektrik gücü.
- "CFC Free" , R-134 A soğutucu gaz.
- 40 kg/m³ yoğunluk.
- Elektronik, sıcaklık ve defrost kontrollü gösterge.
- Defrost esnasında otomatik su buharlaştırma.
- Sökülebilir havalandırma kompresör.
- Fanlı soğutma.
- 48 mm kalınlığında "ozon dostu" poliüretan izolasyon.
- 45 derecede sabit kendiliğinden kapanan kapılar.
- Alüminyum panelli,bakır borulu evaporatör.
- Granit üst tabla.
- Paslanmaz çelik gövde.

English

GRANITE TOP REFRIGERATED COUNTER

- Fermentation drawer capacity: 2 pieces 400x600 mm
- Tray grid capacity: 4 pieces 400x600 mm for each.
- Working temperature; 0° C , + 5° C (at ambient temp. 43° C)
- 220 V-230 V -1 +N -50 60 Hz electrical power.
- "CFC Free" , R-134 A refrigerant gas.
- 40 kg/m³ density.
- Electronic temperature and defrosting control and display.
- Automatic evaporation of water during defrosting.
- Removable,conditioning compressor.
- Fan cooling.
- "Ozone-friendly" 48 mm thickness polyurethane isolation.
- Self closing doors .
- Copper tube evaporator with aluminum fins.
- Granite top.
- Stainless steel body.

**R-290 Soğutucu Gaz Tipi için %3 fiyat farkı ekleyiniz.
Please add %3 price difference for R-290 refrigerant gas.**

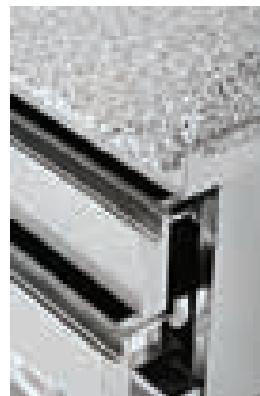

Granit Tablalı Hamur Hazırlık Dolapları Refrigerated Pizza Preparation Counter with Granite Top



Kod Code	Ürün Adı Description	Ebatlar Dimension mm			Ağırlık Weight kg	Net Net m³	Güç Power kw	Kapasite Capacity lt	Fiyatı Price Euro
		a	b	c					
EMP.160.80.02	Granit Tablalı Hamur Hazırlık Dolapları (İki Kapılı) Refrigerated Pizza Preparation Counter with Granite Top (Double Door)	1600	800	1020/1520	220	1.8	0.55	300	3.250
EMP.210.80.02	Granit Tablalı Hamur Hazırlık Dolapları (Üç Kapılı) Refrigerated Pizza Preparation Counter with Granite Top (Triple Door)	2100	800	1020/1520	275	2.3	0.55	500	3.700

Türkçe

GRANİT TABLALI HAMUR HAZIRLIK DOLAPLARI

- 1600 mm'de 1/4-100 7 adet GN.küvet kapasiteli.
- 2100 mm'de 1/4-100 9 adet GN.küvet kapasiteli.
- Her kapakta 4 adet 400x600 mm tepsi kapasitesi.
- 2 adet 400x600 mm mayalandırma çekmecesi.
- Çalışma aralığı; +0 °C , + 5 °C (tropikal 43° C)
- 220 V-230 V -1 +N -50 60 Hz elektrik gücü.
- "CFC Free" , R-134 A soğutucu gaz.
- 40 kg/m³ yoğunluk.
- Elektronik, sıcaklık ve defrost kontrollü gösterge.
- Defrost esnasında otomatik su buharlaştırma.
- Sökülebilir havalandırılmalı kompresör.
- Fanlı soğutuculu alt buzdolabı, statik soğutuculu setüstü saladbar.
- 48 mm kalınlığında "ozon dostu" poliüretan izolasyon.
- 45 derecede sabit kendiliğinden kapanan kapılar.
- Alüminyum panelli,bakır borulu evaporatör.
- Granit veya mermer üst tabla seçeneği.
- Paslanmaz çelik gövde.

*Standart üretimimizde küvet bulunmamaktadır.

English

REFRIGERATED PIZZA PREPARATION COUNTER WITH GRANITE TOP

- Capacity for 2 door: 7 pieces of 1/4-100 gastronorm container.
- Capacity for 3 door: 9 pieces of 1/4-100 gastronorm container.
- Tray grid capacity: 4 pieces 400x600 mm for each.
- Fermentation drawer capacity: 2 pieces 400x600 mm.
- Working temperature; +0° C , + 5° C (at ambient temp. 43° C)
- 220 V-230 V -1 +N -50 60 Hz electrical power.
- "CFC Free" , R-134 A refrigerant gas.
- 40 kg/m3 density.
- Electronic temperature and defrosting control and display.
- Automatic evaporation of water during defrosting.
- Removable,conditioning compressor.
- Fan cooling preparation counter and countertop saladbar with static cooling.
- "Ozone-friendly" 48 mm thickness polyurethane isolation.
- Self closing doors .
- Copper tube evaporator with aluminum fins.
- Granite or marble top table options.
- Stainless steel body.

*Standart product does not have containers.

**R-290 Soğutucu Gaz Tipi için %3 fiyat farkı ekleyiniz.
Please add %3 price difference for R-290 refrigerant gas.**



Dik Tip Buzdolapları (Fanlı)
Refrigerated Cabinets (Fan Cooling)



Kod Code	Ürün Adı Description	Ebatlar Dimension mm			Ağırlık Weight kg	Net Net m³	Güç Power kw	Kapasite Capacity lt	Fiyatı Price Euro
		a	b	c					
EMP.70.80.01	Dik Tip Buzdolabı (Tek Kapılı) Refrigerated Cabinets (Single Door)	700x800x2050			130	1.2	0.4	700	1.575
EMP.70.80.03	Cam Kapı Dik Tip Buzdolabı (Tek Kapılı) Glass Door Refrigerated Cabinets (Single Door)	700x800x2050			145	1.2	0.4	700	1.950

Türkçe

DİK TİP BUZDOLAPLARI (FANLI)

- 3 adet GN 2/1 iç raf.
- Çalışma aralığı; +0 ° C , + 5 ° C (tropikal 43° C)
- 220 V-230 V -1 +N -50 60 Hz elektrik gücü.
- "CFC Free" , R-134 A gaz.
- 40 kg/m3 yoğunluk.
- Elektronik, sıcaklık ve defrost kontrollü gösterge.
- Defrost esnasında otomatik su buharlaştırma.
- Sökülebilir havalandırmalı kompresör.
- Fanlı soğutma.
- 48 mm kalınlığında "ozon dostu" poliüretan izolasyon.
- 45 derecede sabit kendiliğinden kapanan kapılar.
- Alüminyum panelli,bakır borulu evaporatör.
- Paslanmaz çelik gövde.

English

REFRIGERATED CABINETS (FAN COOLING)

- 3 pieces GN 2/1 trays interior shelve.
- Working temperature; 0° C , + 5° C (at ambient temp. 43° C)
- 220 V-230 V -1 +N -50 60 Hz electrical power.
- "CFC Free" , R-134 A gas.
- 40 kg/m3 density.
- Electronic temperature and defrosting control and display.
- Automatic evaporation of water during defrosting.
- Removable,conditioning compressor.
- Fan cooling.
- "Ozone-friendly" 48 mm thickness polyurethane isolation.
- Self closing doors.
- Copper tube evaporator with aluminum fins.
- Stainless steel body.

R-290 Soğutucu Gaz Tipi için %3 fiyat farkı ekleyiniz.
Please add %3 price difference for R-290 refrigerant gas.

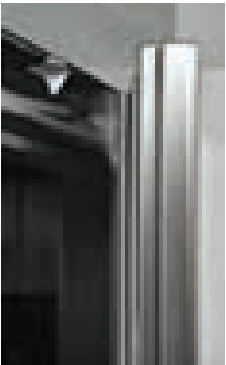

EMP.70.80.03
Cam Kapı Dik Tip Buzdolabı (Tek Kapılı)
Glass Door Refrigerated Cabinets (Single Door)



Dik Tip Buzdolapları (Fanlı) Refrigerated Cabinets (Fan Cooling)



Kod Code	Ürün Adı Description	Ebatlar Dimension mm			Ağırlık Weight kg	Net Net m ³	Güç Power kw	Kapasite Capacity lt	Fiyatı Price Euro
		a	b	c					
EMP.140.80.01	Dik Tip Buzdolabı (Çift Kapılı) Refrigerated Cabinets (Double Door)	1400	800	2050	220	2.4	0.6	1400	2.100
EMP.140.80.03	Cam Kapı Dik Tip Buzdolabı (Çift Kapılı) Glass Door Refrigerated Cabinets (Double Door)	1400	800	2050	230	2.4	0.6	1400	2.780

Türkçe

DİK TİP BUZDOLAPLARI (FANLI)

- 6 adet GN 2/1 iç raf.
- Çalışma aralığı; +0 °C , + 5 °C (tropikal 43° C)
- 220 V-230 V -1 +N -50 60 Hz elektrik gücü.
- "CFC Free" , R-134 A soğutucu gaz.
- 40 kg/m³ yoğunluk.
- Elektronik, sıcaklık ve defrost kontrollü gösterge.
- Defrost esnasında otomatik su buharlaştırma.
- Sökülebilir havalandırmalı kompresör.
- Fanlı soğutma.
- 48 mm kalınlığında "ozon dostu" poliüretan izolasyon.
- 45 derecede sabit kendiliğinden kapanan kapılar.
- Alüminyum panelli,bakır borulu evaporatör.
- Paslanmaz çelik gövde.

English

REFRIGERATED CABINETS (FAN COOLING)

- 6 pieces GN 2/1 trays interior shelve.
- Working temperature; 0° C , + 5° C (at ambient temp. 43° C)
- 220 V-230 V -1 +N -50 60 Hz electrical power.
- "CFC Free" , R-134 A refrigerant gas.
- 40 kg/m³ density.
- Electronic temperature and defrosting control and display.
- Automatic evaporation of water during defrosting.
- Removable,conditioning compressor.
- Fan cooling.
- "Ozone-friendly" 48 mm thickness polyurethane isolation.
- Self closing doors.
- Copper tube evaporator with aluminum fins.
- Stainless steel body.

**R-290 Soğutucu Gaz Tipi için %3 fiyat farkı ekleyiniz.
Please add %3 price difference for R-290 refrigerant gas.**

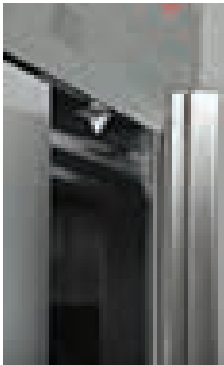

Dik Tip Derin Dondurucu (Fanlı)
Freezer Cabinets (Fan Cooling)



Kod Code	Ürün Adı Description	Ebatlar Dimension mm			Ağırlık Weight kg	Net Net m³	Güç Power kw	Kapasite Capacity lt	Fiyatı Price Euro
		a	b	c					
EMP.70.80.02	Dik Tip Derin Dondurucu (İki Kapılı) Freezer Cabinets (Two Door)	700x800x2050			145	1.2	1	700	2.100
EMP.140.80.02	Dik Tip Derin Dondurucu (Dört Kapılı) Freezer Cabinets (Four Door)	1400x800x2050			245	2.4	1.3	1400	3.150

Türkçe

DİK TİP DERİN DONDURUCU (STATİK SOĞUTMA)

- Tek kapılılar için 3 adet GN 2/1 raf.
- Çift kapılılar için 6 adet GN 2/1 raf.
- Derin dondurucu için çalışma aralığı; -18 ° C , -20 ° C .
- 220 V-230 V -1 +N -50 60 Hz elektrik gücü.
- "CFC Free" , 404A soğutucu gaz.
- 40 kg/m3 yoğunluk.
- Elektronik, sıcaklık ve defrost kontrollü göstere.
- Defrost esnasında otomatik su buharlaştırma.
- Sökülebilir havalandırılmalı kompresör.
- Fanlı soğutma.
- 48 mm kalınlığında "ozon dostu" poliüretan izolasyon.
- 45 derecede sabit kendiliğinden kapanan kapılar.
- Alüminyum panelli,bakır borulu evaporatör.
- Paslanmaz çelik gövde.

English

FREEZER CABINETS (STATIC COOLING)

- For single door; 3 pieces GN 2/1 interior shelve.
- For double doors; 6 pieces GN 2/1 interior shelve.
- Working temperature for freezers;-18° C,-20° C
- 220 V-230 V -1 +N -50 60 Hz electrical power.
- "CFC Free" , 404A gas.
- 40 kg/m3 density.
- Electronic temperature and defrosting control and display.
- Automatic evaporation of water during defrosting.
- Removable,conditioning compressor.
- Fan cooling.
- "Ozone-friendly" 48 mm thickness polyurethane isolation.
- Self closing doors .
- Copper tube evaporator with aluminum fins.
- Stainless steel body.

**R-290 Soğutucu Gaz Tipi için %3 fiyat farkı ekleyiniz.
Please add %3 price difference for R-290 refrigerant gas.**

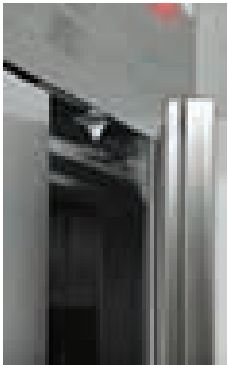



Dik Tip Buzdolapları (Pastane) Refrigerated Cabinets (Patisserie)



Kod Code	Ürün Adı Description	Ebatlar Dimension mm			Ağırlık Weight kg	Net Net m³	Güç Power kw	Kapasite Capacity 40x60 Tepsi/Tray	Fiyatı Price Euro
		a	b	c					
EMP.70.95.01-40	Dik Tip Buzdolabı-Pastane (Fanlı) Refrigerated Cabinet-Patisserie (With Fan)	700	950	2050	150	1.5	0.4	40	2.900

Türkçe

DİK TİP BUZDOLAPLARI (PASTANE)

- 40 kat 40x60 tepsi kapasitesi.
- Çalışma aralığı; +0 °C , + 5 °C (tropikal 43° C)
- 220 V-230 V -1 +N -50 60 Hz elektrik gücü.
- "CFC Free" , R-134 A , Derin dondurucu için 404 A soğutucu gaz.
- 40 kg/m3 yoğunluk.
- Elektronik, sıcaklık ve defrost kontrollü gösterge.
- Defrost esnasında otomatik su buharlaştırma.
- Sökülebilir havalandırmalı kompresör.
- Fanlı soğutma.
- 48 mm kalınlığında "ozon dostu" poliüretan izolasyon.
- 45 derecede sabit kendiliğinden kapanan kapılar.
- Alüminyum panelli,bakır borulu evaporatör.
- Paslanmaz çelik gövde.

English

REFRIGERATED CABINETS (PÂTISSERIE)

- Capacity: 40 pieces 40x60 trays.
- Working temperature; 0° C , + 5° C (at ambient temp.43° C)
- 220 V-230 V -1 +N -50 60 Hz electrical power.
- "CFC Free" , R-134 A for freezer;404 A refrigerant gas
- 40 kg/m3 density.
- Electronic temperature and defrosting control and display.
- Automatic evaporation of water during defrosting.
- Removable,conditioning compressor.
- Fan cooling.
- "Ozone-friendly" 48 mm thickness polyurethane isolation.
- Self closing doors .
- Copper tube evaporator with aluminum fins.
- Stainless steel body.

**R-290 Soğutucu Gaz Tipi için %3 fiyat farkı ekleyiniz.
Please add %3 price difference for R-290 refrigerant gas.**



Dik Tip Derin Dondurucular (Pastane)
Freezer Cabinets (Patisserie)



Kod Code	Ürün Adı Description	Ebatlar Dimension mm			Ağırlık Weight kg	Net Net m³	Güç Power kw	Kapasite Capacity 40x60 Tepsi/Tray	Fiyatı Price Euro
		a	b	c					
EMP.70.95.02-40	Dik Tip Derin Dondurucu-Pastane (Fanlı) Freezer Cabinet-Patisserie (With Fan)	700	950	2050	150	1.5	1	40	3.200

Türkçe

DİK TİP DERİN DONDURUCULAR (PASTANE)

- 40 kat 40x60 tepsi kapasitesi.
- Derin dondurucu için çalışma aralığı; -18 ° C , -20 ° C
- 220 V-230 V -1 +N -50 60 Hz elektrik gücü.
- "CFC Free" , R-134 A , Derin dondurucu için 404 A soğutucu gaz.
- 40 kg/m3 yoğunluk.
- Elektronik, sıcaklık ve defrost kontrollü gösterge.
- Defrost esnasında otomatik su buharlaştırma.
- Sökülebilir havalandırmalı kompresör.
- Fanlı soğutma.
- 48 mm kalınlığında "ozon dostu" poliüretan izolasyon.
- 45 derecede sabit kendiliğinden kapanan kapılar.
- Alüminyum panelli,bakır borulu evaporatör.
- Paslanmaz çelik gövde.

**R-290 Soğutucu Gaz Tipi için %3 fiyat farkı ekleyiniz.
Please add %3 price difference for R-290 refrigerant gas.**

English

FREEZER CABINETS (PATISSERIE)

- Capacity: 40 pieces 40x60 trays.
- Working temperature for freezers;-18° C,-20° C
- 220 V-230 V -1 +N -50 60 Hz electrical power.
- "CFC Free" , R-134 A for freezer;404 A refrigerant gas
- 40 kg/m3 density.
- Electronic temperature and defrosting control and display.
- Automatic evaporation of water during defrosting.
- Removable,conditioning compressor.
- Fan cooling.
- "Ozone-friendly" 48 mm thickness polyurethane isolation.
- Self closing doors .
- Copper tube evaporator with aluminum fins.
- Stainless steel body.



Dik Tip Buzdolapları (Pastane) Refrigerated Cabinets (Patisserie)



Kod Code	Ürün Adı Description	Ebatlar Dimension mm			Ağırlık Weight kg	Net Net m³	Güç Power kw	Kapasite Capacity lt	Fiyatı Price Euro
		a	b	c					
EMP.70.95.01	Dik Tip Buzdolabı-Pastane (Fanlı) Refrigerated Cabinet-Patisserie (With Fan)	700x800x2050			130	1.2	0.4	700	2.100
EMP.140.95.01	Dik Tip Buzdolabı-Pastane (Fanlı) Refrigerated Cabinet-Patisserie (With Fan)	1400x800x2050			220	2.4	0.6	1400	3.150

Türkçe

DİK TİP BUZDOLAPLARI (PASTANE)

- 20 kat 40x60 tepsi kapasitesi (tek kapılılar için).
- 2x20 kat 40x60 tepsi kapasitesi (çift kapılılar için).
- Çalışma aralığı; +0 ° C , + 5 ° C (tropikal 43° C)
- 220 V-230 V -1 +N -50 60 Hz elektrik gücü.
- "CFC Free" , R-134 A , Derin dondurucu için 404 A soğutucu gaz.
- 40 kg/m3 yoğunluk.
- Elektronik, sıcaklık ve defrost kontrollü gösterge.
- Defrost esnasında otomatik su buharlaştırma.
- Sökülebilir havalandırmalı kompresör.
- Fanlı soğutma.
- 48 mm kalınlığında "ozon dostu" poliüretan izolasyon.
- 45 derecede sabit kendiliğinden kapanan kapılar.
- Alüminyum panelli,bakır borulu evaporatör.
- Paslanmaz çelik gövde.

English

REFRIGERATED CABINETS (PÂTISSERIE)

- Capacity: 20 pieces 40x60 trays (for single door).
- Capacity: 2x200 pieces 40x60 trays (for double doors).
- Working temperature; 0° C , + 5° C (at ambient temp.43° C)
- 220 V-230 V -1 +N -50 60 Hz electrical power.
- "CFC Free" , R-134 A for freezer;404 A refrigerant gas
- 40 kg/m3 density.
- Electronic temperature and defrosting control and display.
- Automatic evaporation of water during defrosting.
- Removable,conditioning compressor.
- Fan cooling.
- "Ozone-friendly" 48 mm thickness polyurethane isolation.
- Self closing doors .
- Copper tube evaporator with aluminum fins.
- Stainless steel body.

**R-290 Soğutucu Gaz Tipi için %3 fiyat farkı ekleyiniz.
Please add %3 price difference for R-290 refrigerant gas.**

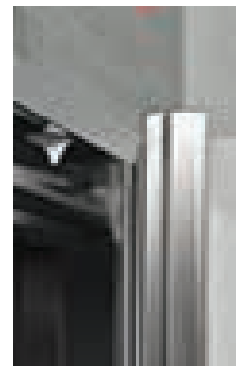

Dik Tip Derin Dondurucular (Pastane)
Freezer Cabinets (Patisserie)



Kod Code	Ürün Adı Description	Ebatlar Dimension mm			Ağırlık Weight kg	Net Net m³	Güç Power kw	Kapasite Capacity lt	Fiyatı Price Euro
		a	b	c					
EMP.70.95.02	Dik Tip Derin Dondurucu-Pastane (Fanlı) Freezer Cabinet-Patisserie (With Fan)	700x800x2050			145	1.2	1	700	2.575
EMP.140.95.02	Dik Tip Derin Dondurucu-Pastane (Fanlı) Freezer Cabinet-Patisserie (With Fan)	1400x800x2050			290	2.4	1.3	1400	4.100

Türkçe

DİK TİP DERİN DONDURUCULAR (PASTANE)

- 20 kat 40x60 tepsi kapasitesi (tek kapılılar için).
- 2x20 kat 40x60 tepsi kapasitesi (çift kapılılar için).

- Derin dondurucu için çalışma aralığı; -18 ° C , -20 ° C
- 220 V-230 V -1 +N -50 60 Hz elektrik gücü.
- "CFC Free" , R-134 A , Derin dondurucu için 404 A soğutucu gaz.
- 40 kg/m3 yoğunluk.
- Elektronik, sıcaklık ve defrost kontrollü gösterge.
- Defrost esnasında otomatik su buharlaştırma.
- Sökülebilir havalandırmalı kompresör.
- Fanlı soğutma.
- 48 mm kalınlığında "ozon dostu" poliüretan izolasyon.
- 45 derecede sabit kendiliğinden kapanan kapılar.
- Alüminyum panelli,bakır borulu evaporatör.
- Paslanmaz çelik gövde.

English

FREEZER CABINETS (PATISSERIE)

- Capacity: 20 pieces 40x60 trays (for single door).
- Capacity: 2x200 pieces 40x60 trays (for double doors).

- Working temperature for freezers; -18° C, -20° C
- 220 V-230 V -1 +N -50 60 Hz electrical power.
- "CFC Free" , R-134 A for freezer; 404 A refrigerant gas
- 40 kg/m3 density.
- Electronic temperature and defrosting control and display.
- Automatic evaporation of water during defrosting.
- Removable, conditioning compressor.
- Fan cooling.
- "Ozone-friendly" 48 mm thickness polyurethane isolation.
- Self closing doors .
- Copper tube evaporator with aluminum fins.
- Stainless steel body.

**R-290 Soğutucu Gaz Tipi için %3 fiyat farkı ekleyiniz.
Please add %3 price difference for R-290 refrigerant gas.**



Soğuk Oda Depoları (0° C / +8° C)
 Cold Room (0° C / +8° C)

80 mm Oda Paneli / 80 mm Room Panel

Kod Code	Ürün Adı Description	Ebatlar Dimension mm			Hacim Volume m³	Fiyatı Price Euro
		a	b	c		
EMP.SP.1215	80 mm Oda Paneli 80 mm Room Panel	1200x1500x2200			2,8	2.320
EMP.SG.1215	SD.1215 Soğutma Grubu SD.1215 Cooling Group	1/2 Hp			2,6-5	2.692
EMP.SP.1515	80 mm Oda Paneli 80 mm Room Panel	1500x1500x2200			3,7	2.611
EMP.SG.1515	SD.1515 Soğutma Grubu SD.1515 Cooling Group	1/2 Hp			2,6-5	2.692
EMP.SP.1815	80 mm Oda Paneli 80 mm Room Panel	1800x1500x2200			4,5	2.815
EMP.SG.1815	SD.1815 Soğutma Grubu SD.1815 Cooling Group	1/2 Hp			2,6-5	2.692
EMP.SP.2115	80 mm Oda Paneli 80 mm Room Panel	2100x1500x2200			5,3	3.221
EMP.SG.2115	SD.2115 Soğutma Grubu SD.2115 Cooling Group	1/2 Hp			5,1-7,5	2.872
EMP.SP.2415	80 mm Oda Paneli 80 mm Room Panel	2400x1500x2200			6,1	3.440
EMP.SG.2415	SD.2415 Soğutma Grubu SD.2415 Cooling Group	1/2 Hp			5,1-7,5	2.872
EMP.SP.2715	80 mm Oda Paneli 80 mm Room Panel	2700x1500x2200			6,9	3.846
EMP.SG.2715	SD.2715 Soğutma Grubu SD.2715 Cooling Group	1/2 Hp			5,1-7,5	2.872
EMP.SP.3015	80 mm Oda Paneli 80 mm Room Panel	3000x1500x2200			7,8	4.020
EMP.SG.3015	SD.3015 Soğutma Grubu SD.3015 Cooling Group	3/4 Hp			7,6-10	2.980

Kod Code	Ürün Adı Description	Ebatlar Dimension mm			Hacim Volume m³	Fiyatı Price Euro
		a	b	c		
EMP.SP.1218	80 mm Oda Paneli 80 mm Room Panel	1200x1800x2200			3,5	2.368
EMP.SG.1218	SD.1218 Soğutma Grubu SD.1218 Cooling Group	1/2 Hp			2,6-5	2.692
EMP.SP.1518	80 mm Oda Paneli 80 mm Room Panel	1500x1800x2200			4,5	2.815
EMP.SG.1518	SD.1518 Soğutma Grubu SD.1518 Cooling Group	1/2 Hp			2,6-5	2.692
EMP.SP.1818	80 mm Oda Paneli 80 mm Room Panel	1800x1800x2200			5,5	2.974
EMP.SG.1818	SD.1818 Soğutma Grubu SD.1818 Cooling Group	1/2 Hp			5,1-7,5	2.692
EMP.SP.2118	80 mm Oda Paneli 80 mm Room Panel	2100x1800x2200			6,5	3.440
EMP.SG.2118	SD.2118 Soğutma Grubu SD.2118 Cooling Group	1/2 Hp			5,1-7,5	2.872
EMP.SP.2418	80 mm Oda Paneli 80 mm Room Panel	2400x1800x2200			7,5	3.659
EMP.SG.2418	SD.2418 Soğutma Grubu SD.2418 Cooling Group	1/2 Hp			5,1-7,5	2.872
EMP.SP.2718	80 mm Oda Paneli 80 mm Room Panel	2700x1800x2200			8,5	4.096
EMP.SG.2718	SD.2718 Soğutma Grubu SD.2718 Cooling Group	3/4 Hp			7,6-10	2.980
EMP.SP.3018	80 mm Oda Paneli 80 mm Room Panel	3000x1800x2200			9,5	4.300
EMP.SG.3018	SD.3018 Soğutma Grubu SD.3018 Cooling Group	3/4 Hp			7,6-10	2.980

- Kapı ölçüsü 700x1845 mm
 - Door dimension : 700x1845 mm

SOĞUK ODA FİYATLARINA PANEL VE SOĞUTMA GRUBU MONTAJ FİYATLARI DAHİL DEĞİLDİR.
INSTALLATION OF COLD ROOMS IS NOT INCLUDED TO THE COLD ROOM PRICES.

Soğuk Oda Depoları (0° C / +8° C)
Cold Room (0° C / +8° C)



80 mm Oda Paneli / 80 mm Room Panel

Kod Code	Ürün Adı Description	Ebatlar Dimension mm			Hacim Volume m³	Fiyatı Price Euro	Kod Code	Ürün Adı Description	Ebatlar Dimension mm			Hacim Volume m³	Fiyatı Price Euro
		a	b	c					a	b	c		
EMP.SP.1221	80 mm Oda Paneli 80 mm Room Panel	1200x2100x2200			4,1	2.774	EMP.SP.1227	80 mm Oda Paneli 80 mm Room Panel	1200x2700x2200			5,4	3.166
EMP.SG.1221	SD.1221 Soğutma Grubu SD.1221 Cooling Group	1/2 Hp			2,6-5	2.692	EMP.SG.1227	SD.1227 Soğutma Grubu SD.1227 Cooling Group	1/2 Hp			5,1-7,5	2.872
EMP.SP.1521	80 mm Oda Paneli 80 mm Room Panel	1500x2100x2200			5,3	3.221	EMP.SP.1527	80 mm Oda Paneli 80 mm Room Panel	1500x2700x2200			6,9	3.846
EMP.SG.1521	SD.1521 Soğutma Grubu SD.1521 Cooling Group	1/2 Hp			5,1-7,5	2.872	EMP.SG.1527	SD.1527 Soğutma Grubu SD.1527 Cooling Group	1/2 Hp			5,1-7,5	2.872
EMP.SP.1821	80 mm Oda Paneli 80 mm Room Panel	1800x2100x2200			6,5	3.440	EMP.SP.1827	80 mm Oda Paneli 80 mm Room Panel	1800x2700x2200			8,5	4.096
EMP.SG.1821	SD.1821 Soğutma Grubu SD.1821 Cooling Group	1/2 Hp			5,1-7,5	2.872	EMP.SG.1827	SD.1827 Soğutma Grubu SD.1827 Cooling Group	1/2 Hp			7,6-10	2.980
EMP.SP.2121	80 mm Oda Paneli 80 mm Room Panel	2100x2100x2200			7,7	3.909	EMP.SP.2127	80 mm Oda Paneli 80 mm Room Panel	2100x2700x2200			10,1	4.660
EMP.SG.2121	SD.2121 Soğutma Grubu SD.2121 Cooling Group	3/4 Hp			7,6-10	2.980	EMP.SG.2127	SD.2127 Soğutma Grubu SD.2127 Cooling Group	3/4 Hp			10,1-15	4.129
EMP.SP.2421	80 mm Oda Paneli 80 mm Room Panel	2400x2100x2200			8,9	4.159	EMP.SP.2427	80 mm Oda Paneli 80 mm Room Panel	2400x2700x2200			11,6	4.910
EMP.SG.2421	SD.2421 Soğutma Grubu SD.2421 Cooling Group	3/4 Hp			7,6-10	2.980	EMP.SG.2427	SD.2427 Soğutma Grubu SD.2427 Cooling Group	3/4 Hp			10,1-15	4.129
EMP.SP.2721	80 mm Oda Paneli 80 mm Room Panel	2700x2100x2200			10,1	4.660	EMP.SP.2727	80 mm Oda Paneli 80 mm Room Panel	2700x2700x2200			13,2	5.249
EMP.SG.2721	SD.2721 Soğutma Grubu SD.2721 Cooling Group	3/4 Hp			10,1-15	4.129	EMP.SG.2727	SD.2727 Soğutma Grubu SD.2727 Cooling Group	3/4 Hp			10,1-15	4.129
EMP.SP.3021	80 mm Oda Paneli 80 mm Room Panel	3000x2100x2200			11,2	4.910	EMP.SP.3027	80 mm Oda Paneli 80 mm Room Panel	3000x2700x2200			14,7	5.459
EMP.SG.3021	SD.3021 Soğutma Grubu SD.3021 Cooling Group	3/4 Hp			10,1-15	4.129	EMP.SG.3027	SD.3027 Soğutma Grubu SD.3027 Cooling Group	3/4 Hp			10,1-15	4.129

- Kapı ölçüsü 700x1845 mm
- Door dimension : 700x1845 mm

SOĞUK ODA FİYATLARINA PANEL VE SOĞUTMA GRUBU MONTAJ FİYATLARI DAHİL DEĞİLDİR.
INSTALLATION OF COLD ROOMS IS NOT INCLUDED TO THE COLD ROOM PRICES.

Soğuk Oda Depoları (0° C /-20° C)
 Cold Room (0° C / -20° C)

120 mm Oda Paneli / 120 mm Room Panel

Kod Code	Ürün Adı Description	Ebatlar Dimension mm			Hacim Volume m ³	Fiyatı Price Euro	Kod Code	Ürün Adı Description	Ebatlar Dimension mm			Hacim Volume m ³	Fiyatı Price Euro
		a	b	c					a	b	c		
EMP.SN.1215	120 mm Oda Paneli 120 mm Room Panel	1200x1500x2200			2,4	2.668	EMP.SN.1218	120 mm Oda Paneli 120 mm Room Panel	1200x1800x2200			3,0	2.912
EMP.SGN.1215	SN.1215 Soğutma Grubu SN.1215 Cooling Group	1-1/2 Hp			2,4-5	3.231	EMP.SGN.1218	SN.1218 Soğutma Grubu SN.1218 Cooling Group	1-1/2 Hp			3-5	3.231
EMP.SN.1515	120 mm Oda Paneli 120 mm Room Panel	1500x1500x2200			3,1	3.003	EMP.SN.1518	120 mm Oda Paneli 120 mm Room Panel	1500x1800x2200			3,9	3.238
EMP.SGN.1515	SN.1515 Soğutma Grubu SN.1515 Cooling Group	1-1/2 Hp			2,6-5	3.231	EMP.SGN.1518	SN.1518 Soğutma Grubu SN.1518 Cooling Group	1-1/2 Hp			3-5	3.231
EMP.SN.1815	120 mm Oda Paneli 120 mm Room Panel	1800x1500x2200			3,9	3.238	EMP.SN.1818	120 mm Oda Paneli 120 mm Room Panel	1800x1800x2200			4,8	3.420
EMP.SGN.1815	SN.1815 Soğutma Grubu SN.1815 Cooling Group	1-1/2 Hp			2,6-5	3.231	EMP.SGN.1818	SN.1818 Soğutma Grubu SN.1818 Cooling Group	1-1/2 Hp			3-5	3.339
EMP.SN.2115	120 mm Oda Paneli 120 mm Room Panel	2100x1500x2200			4,6	3.704	EMP.SN.2118	120 mm Oda Paneli 120 mm Room Panel	2100x1800x2200			5,7	3.957
EMP.SGN.2115	SN.2115 Soğutma Grubu SN.2115 Cooling Group	1-1/2 Hp			2,6-5	3.231	EMP.SGN.2118	SN.2118 Soğutma Grubu SN.2118 Cooling Group	1-1/2 Hp			5,1-7,5	3.339
EMP.SN.2415	120 mm Oda Paneli 120 mm Room Panel	2400x1500x2200			5,3	3.957	EMP.SN.2418	120 mm Oda Paneli 120 mm Room Panel	2400x1800x2200			6,6	4.208
EMP.SGN.2415	SN.2415 Soğutma Grubu SN.2415 Cooling Group	1-1/2 Hp			5,1-7,5	3.339	EMP.SGN.2418	SN.2418 Soğutma Grubu SN.2418 Cooling Group	1-1/2 Hp			5,1-7,5	3.339
EMP.SN.2715	120 mm Oda Paneli 120 mm Room Panel	2700x1500x2200			6,1	4.423	EMP.SN.2718	120 mm Oda Paneli 120 mm Room Panel	2700x1800x2200			7,5	4.711
EMP.SGN.2715	SN.2715 Soğutma Grubu SN.2715 Cooling Group	1-1/2 Hp			5,1-7,5	3.339	EMP.SGN.2718	SN.2718 Soğutma Grubu SN.2718 Cooling Group	1-1/2 Hp			5,1-7,5	3.339
EMP.SG.3015	120 mm Oda Paneli 120 mm Room Panel	3000x1500x2200			6,8	4.622	EMP.SN.3018	120 mm Oda Paneli 120 mm Room Panel	3000x1800x2200			8,4	4.945
EMP.SGN.3015	SN.3015 Soğutma Grubu SN.3015 Cooling Group	1-1/2 Hp			5,1-7,5	3.339	EMP.SGN.3018	SN.3018 Soğutma Grubu SN.3018 Cooling Group	2 Hp			7,6-10	4.667

- Kapı ölçüsü 700x1765 mm

- Door dimension : 700x1765 mm

SOĞUK ODA FİYATLARINA PANEL VE SOĞUTMA GRUBU MONTAJ FİYATLARI DAHİL DEĞİLDİR.
INSTALLATION OF COLD ROOMS IS NOT INCLUDED TO THE COLD ROOM PRICES.

Soğuk Oda Depoları (0° C / -20° C)
Cold Room (0° C / -20° C)



120 mm Oda Paneli / 120 mm Room Panel



Kod Code	Ürün Adı Description	Ebatlar Dimension mm			Hacim Volume m³	Fiyatı Price Euro	Kod Code	Ürün Adı Description	Ebatlar Dimension mm			Hacim Volume m³	Fiyatı Price Euro
		a	b	c					a	b	c		
EMP.SN.1221	120 mm Oda Paneli 120 mm Room Panel	1200x2100x2200			3,5	3.190	EMP.SN.1227	120 mm Oda Paneli 120 mm Room Panel	1200x2700x2200			4,6	3.813
EMP.SGN.1221	SN.1221 Soğutma Grubu SN.1221 Cooling Group	1-1/2 Hp			2,6-5	3.231	EMP.SGN.1227	SN.1227 Soğutma Grubu SN.1227 Cooling Group	1-1/2 Hp			3-5	3.231
EMP.SN.1521	120 mm Oda Paneli 120 mm Room Panel	1500x2100x2200			4,6	3.704	EMP.SN.1527	120 mm Oda Paneli 120 mm Room Panel	1500x2700x2200			6,1	4.423
EMP.SGN.1521	SN.1521 Soğutma Grubu SN.1521 Cooling Group	1-1/2 Hp			2,6-5	3.231	EMP.SGN.1527	SN.1527 Soğutma Grubu SN.1527 Cooling Group	1-1/2 Hp			5,1-7,5	3.339
EMP.SN.1821	120 mm Oda Paneli 120 mm Room Panel	1800x2100x2200			5,7	3.957	EMP.SN.1827	120 mm Oda Paneli 120 mm Room Panel	1800x2700x2200			7,5	4.711
EMP.SGN.1821	SN.1821 Soğutma Grubu SN.1821 Cooling Group	1-1/2 Hp			5,1-7,5	3.339	EMP.SGN.1827	SN.1827 Soğutma Grubu SN.1827 Cooling Group	1-1/2 Hp			5,1-7,5	3.339
EMP.SN.2121	120 mm Oda Paneli 120 mm Room Panel	2100x2100x2200			6,8	4.496	EMP.SN.2127	120 mm Oda Paneli 120 mm Room Panel	2100x2700x2200			9,0	5.359
EMP.SGN.2121	SN.2121 Soğutma Grubu SN.2121 Cooling Group	1-1/2 Hp			5,1-7,5	3.339	EMP.SGN.2127	SN.2127 Soğutma Grubu SN.2127 Cooling Group	2 Hp			7,6-10	4.667
EMP.SN.2421	120 mm Oda Paneli 120 mm Room Panel	2400x2100x2200			7,9	4.784	EMP.SN.2427	120 mm Oda Paneli 120 mm Room Panel	2400x2700x2200			10,4	5.646
EMP.SGN.2421	SN.2421 Soğutma Grubu SN.2421 Cooling Group	2 Hp			7,6-10	4.667	EMP.SGN.2427	SN.2427 Soğutma Grubu SN.2427 Cooling Group	2 Hp			10,1-15	4.847
EMP.SN.2721	120 mm Oda Paneli 120 mm Room Panel	2700x2100x2200			9,0	5.359	EMP.SN.2727	120 mm Oda Paneli 120 mm Room Panel	2700x2700x2200			11,9	5.963
EMP.SGN.2721	SN.2721 Soğutma Grubu SN.2721 Cooling Group	2 Hp			7,6-10	4.667	EMP.SGN.2727	SN.2727 Soğutma Grubu SN.2727 Cooling Group	2 Hp			10,1-15	4.847
EMP.SN.3021	120 mm Oda Paneli 120 mm Room Panel	3000x2100x2200			10,1	5.646	EMP.SN.3027	120 mm Oda Paneli 120 mm Room Panel	3000x2700x2200			13,3	6.277
EMP.SGN.3021	SN.3021 Soğutma Grubu SN.3021 Cooling Group	2 Hp			10,1-15	4.847	EMP.SGN.3027	SN.3027 Soğutma Grubu SN.3027 Cooling Group	2 Hp			10,1-15	4.847

- Kapı ölçüsü 700x1765 mm
- Door dimension : 700x1765 mm

SOĞUK ODA FİYATLARINA PANEL VE SOĞUTMA GRUBU MONTAJ FİYATLARI DAHİL DEĞİLDİR.
INSTALLATION OF COLD ROOMS IS NOT INCLUDED TO THE COLD ROOM PRICES.

Modüler Soğuk Odalar
Modular Cold Room

Türkçe

Modüler Soğuk Odalar
Genel Özellikleri

- Ürünler 80mm veya 120mm' lik panel kalınlığı ile istenilen ölçülerde ve ısılarda üretilmektedir.
- Bütün odalarımız modüler sistemde sökülebilir ve montaj edilebilmektedir.
- İç ve Dış cepheler PVC kaplı galvaniz ile hijyen kurallarına en uygun şekilde üretilmektedir.
- Bütün izolasyon CFC free yüksek basınç Poliüretan izolasyon ile sağlanmaktadır.
- Kolay açılabilir ve kapanabilir kilit sistemi ile hızlı montaj yapılabilmektedir.
- Tabanlar 304 kalite paslanmaz kaymaz özel saçtan imal edilebilmektedir.
- 80mm veya 120mm Panel Kalınlığı
- 42Kg/m3 densite poliüretan izolasyon.
- Modüler paneller - Kolay Montaj ve ayırabilme
- 3 Panel ölçüsü - 300/600/900 ve köşe bölümü 15x45/45x45/45x60/15x60
- İki taraflı kilitleme sistemi, dişi-erkek; mükemmel birleşim, civatasız silikonsuz montaj.
- Tabansız oda seçeneği, arabaların kolay girişi, çıkışı.
- Yuvarlatılmış köşeler, Özel paslanmaz zemin.
- Contalı ve kolay ısıtılabilir kapı. Mükemmel kapanım.
- Soğutma bölümünün farklı yerlere yerleştirilebilme özelliği.
- +43 derece ortam sıcaklığında çalışma

English

Modular Cold Room
General Features

- The panels thickness is 80mm or 120mm Temperature range is 0 / +8 ; 10 / -25 C
- All Rooms are modular (meaning that it could be easily installed and separated).
- The internal and external finish products are realized with PVC coated galvanized sheet
- The insulation of modular panels is with high density polyurethane, which is HCFC free.
- Quickly and easily assemble due to the integral locking system.
- The floor is anti-slip Stainless steel AISI 304.
- 80mm or 120mm panel thickness
- 42kg / m3 density polyurethane insulation.
- Modular panels - easily assembled and separated
- 3 panels size, 300/600/900 and corner section 15x45/45x45/45x60/15x60
- two-side locking system, female-male; perfect combination, installation without any bolt or silicone.
- Rounded corners and special stainless steel for the floor.
- Door with gasket and heater easily.
- Cooling section unit can be positioned anywhere
- 43 degree ambient working temperatures.



Teshir 
Display



Life's Magic / Kitchen of Business

empero@empero.com.tr



- * **Salat Bar (Nötr) / Buffet Salad Bar (Neutral)**
- * **Salat Bar (Soğutmalı) / Buffet Salad Bar (Cold)**
- * **Benmariler / Buffet (Hot)**
- * **Benmari ve Nötr Servis Üniteleri / Bain marie and Neutral Service Units**
- * **Düz Camlı Servis Üniteleri / Flat Glass Service Units**
- * **Bombe Camlı Servis Üniteleri / Convex Glass Service Units**
- * **Benmari Servis Üniteleri / Bain marie Service Units**
- * **Benmari Servis Ünite Aksesuarları / Bain marie Service Unit Accessories**
- * **Benmari Servis Ünite Aksesuarları / Bain marie Service Unit Accessories**
- * **Benmari Servis Ünite Aksesuarları / Bain marie Service Unit Accessories**
- * **Soğuk Servis Üniteleri (Buzdolaplı) / Cold Service Units (Refrigerated)**
- * **Soğuk Servis Ünite Aksesuarları / Cold Service Unit Accessories**
- * **Soğuk Servis Ünite Aksesuarları / Cold Service Unit Accessories**
- * **Soğuk Servis Üniteleri / Cold Service Units**
- * **Soğuk Servis Ünite Aksesuarları / Cold Service Unit Accessories**

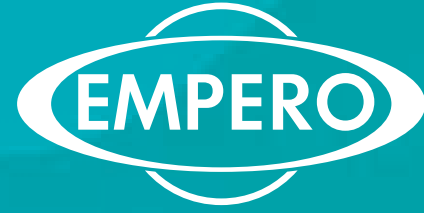

- Soğuk Servis Ünite Aksesuarları / Cold Service Unit Accessories ***
- Ocakbaşı / Display Type Grill ***
 - Ocakbaşı Aksesuarları / Display Type Grill Accessories ***
 - Kömürlü Izgara / Charcoal Grill ***
 - Nötr Servis Üniteleri / Neutral Service Units ***
 - Nötr Servis Ünite Aksesuarları / Neutral Service Unit Accessories ***
 - Nötr Servis Ünite Aksesuarları / Neutral Service Unit Accessories ***
 - Nötr Servis Ünite Aksesuarları / Neutral Service Unit Accessories ***
 - Köşe Tezgahı ve Küver Ünitesi / Corner Service Table and Cutlery Unit ***
 - Köşe Tezgahı ve Küver Ünite Aksesuarları / Corner Service Table and Cutlery Unit Accessories ***
 - Merkür Et ve Meze Vitrinleri (Bombe Cam) / Mercury Meat and Appetizer Showcases (Convex Glass) ***
 - Merkür Et ve Meze Vitrinleri (Düz Cam) / Mercury Meat and Appetizer Showcases (Flat Glass) ***
 - Plüton Et ve Meze Teşhir Vitrinleri (Düz Camlı) / Pluton Meat and Appetizer Showcase (Flat Glass) ***
 - Plüton Et ve Meze Teşhir Vitrinleri (Bombe Camlı) / Pluton Meat and Appetizer Showcase (Convex Glass) ***
 - Venüs Pasta Vitrinleri / Venus Pastry Showcase ***
 - Neptün Pasta Vitrinleri / Neptun Pastry Showcase ***

Salat Bar (Nötr)
Buffet Salad Bar (Neutral)

Kod Code	Ürün Adı Description	Ebatlar Dimension mm			Ağırlık Weight kg	Net Net m ³	Fiyatı Price Euro
		a	b	c			
EMP.SB.03-N	Salat Bar - Nötr Buffet Salad Bar - Neutral	1180	890	870/1370	125	1.43	1.420
EMP.SB.04-N	Salat Bar - Nötr Buffet Salad Bar - Neutral	1500	890	870/1370	146	1.82	1.620
EMP.SB.05-N	Salat Bar - Nötr Buffet Salad Bar - Neutral	1800	890	870/1370	163	2.19	1.800
EMP.SB.06-N	Salat Bar - Nötr Buffet Salad Bar - Neutral	2100	890	870/1370	184	2.50	2.050

Türkçe

SALAT BAR (NÖTR)

- Granit üst tabla.
- Aydınlatma Sistemi.
- Opsiyonel ahşap gövde.
- Çıkartılabilir üst servis rafı.

English

BUFFET SALAD BAR (NEUTRAL)

- Granite table top.
- Lightining system.
- Optional wooden body colour.
- Lift-Up Safety Glass Breath Shield.



Salat Bar (Soğutmalı)
Buffet Salad Bar (Cold)



Kod Code	Ürün Adı Description	Ebatlar Dimension mm			Ağırlık Weight kg	Net Net m³	Güç Power kw	Kapasite Capacity	Fiyatı Price Euro
		a	b	c					
EMP.SB.03	Salat Bar-Soğutmalı Buffet Salad Bar -Cold	1180x890x870/1370			125	1.43	1.3	3X1/1 GN	1.900
EMP.SB.04	Salat Bar-Soğutmalı Buffet Salad Bar -Cold	1500x890x870/1370			146	1.82	1.3	4x1/1 GN	2.000
EMP.SB.05	Salat Bar-Soğutmalı Buffet Salad Bar -Cold	1800x890x870/1370			163	2.19	1.3	5x1/1 GN	2.100
EMP.SB.06	Salat Bar-Soğutmalı Buffet Salad Bar -Cold	2100x890x870/1370			184	2.50	1.3	6x1/1 GN	2.625



Türkçe

SALAT BAR (SOĞUTMALI)

- Paslanmaz çelik havuz.
- 220V 50Hz enerji.
- Serpantin soğutma sistemi.
- 40 kg/m3 yoğunluk poliüretan izolasyon.
- Aydınlatma Sistemi.
- R-134 A soğutucu gaz.
- Opsiyonel ahşap gövde.
- Çıkartılabilir üst servis rafı

*Standart üretimimizde küvet bulunmamaktadır.

English

BUFFET SALAD BAR (COLD)

- Stainless steel well.
- 220V 50Hz energy.
- Serpentine cooling system.
- 40 kg/m3 density polyurethane isolation.
- Lightining system.
- Refrigerant gas:R-134 A
- Optional wooden body colour.
- Lift-Up Safety Glass Breath Shield.

*Standart product does not have containers.

**R-290 Soğutucu Gaz Tipi için %3 fiyat farkı ekleyiniz.
Please add %3 price difference for R-290 refrigerant gas.**

Renk Seçenekleri
Color Options



1



2



3

1 Fındık
Hazelnut

2 Kül Meşe
Ash Oak

3 Samba Ceviz
Samba Walnut

Benmariler
Buffet (Hot)

Kod Code	Ürün Adı Description	Ebatlar Dimension mm			Ağırlık Weight kg	Net Net m ²	Güç Power kw	Kapasite Capacity	Fiyatı Price Euro
		a	b	c					
EMP.SBS.03	Benmari Buffet-Hot	1180x890x870/1370			125	1.43	2.7	3x1/1 GN	1.420
EMP.SBS.04	Benmari Buffet-Hot	1500x890x870/1370			146	1.82	2.7	4x1/1 GN	1.575
EMP.SBS.05	Benmari Buffet-Hot	1800x890x870/1370			163	2.19	4.3	5x1/1 GN	1.785
EMP.SBS.06	Benmari Buffet-Hot	2100x890x870/1370			184	2.50	5.4	6x1/1 GN	2.200

Türkçe

BENMARİ

- Termostatik kumanda.
- 220 V 50 Hz enerji.
- Paslanmaz çelik havuz.
- Su tahliye vanası.
- Aydınlatma Sistemi.
- Opsiyonel ahşap gövde.
- Çıkarılabilir üst servis rafı

*Standart üretimimizde küvet bulunmamaktadır.

English

BUFFET (HOT)

- Thermostatic control.
- Power:220 V 50 Hz
- Stainless steel well.
- Water drainage valve.
- Lightining system.
- Optional wooden body colour.
- Lift-Up Safety Glass Breath Shield.

*Standart product does not have containers.



1 Fındık
Hazelnut

2 Kül Meşe
Ash Oak

3 Samba Ceviz
Samba Walnut

Benmari ve Nötr Servis Üniteleri Bain marie and Neutral Service Units

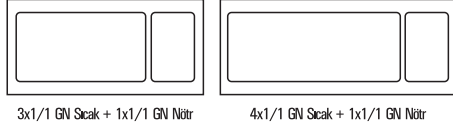

Kod Code	Ürün Adı Description	Ebatlar Dimension mm			Ağırlık Weight kg	Net Net m³	Güç Power kw	Kapasite Capacity	Fiyatı Price Euro
		a	b	c					
EMP.BEN.31	Servis Ünitesi-Üst Rafı-Sürgü Standlı Service Unit-Top Shelf-Sliding Tray	1500	790	850/1350	99	1.5	2.7	3 Sıcak+1 Nötr/ 3 Hot+1 Neutral	2.100
EMP.BEN.41	Servis Ünitesi-Üst Rafı-Sürgü Standlı Service Unit-Top Shelf-Sliding Tray	1800	790	850/1350	118	1.8	2.7	4 Sıcak+1 Nötr/ 4 Hot+1 Neutral	2.575
EMP.BEN.31.AD	Servis Ünitesi-Üst Rafı-Sürgü Standlı (Ahşap Dekorlu) Service Unit-Top Shelf-Sliding Tray-(Wooden Decorated)	1500	790	850/1350	99	1.5	2.7	3 Sıcak+1 Nötr/ 3 Hot+1 Neutral	2.365
EMP.BEN.41.AD	Servis Ünitesi-Üst Rafı-Sürgü Standlı (Ahşap Dekorlu) Service Unit-Top Shelf-Sliding Tray-(Wooden Decorated)	1800	790	850/1350	118	1.8	2.7	4 Sıcak+1 Nötr/ 4 Hot+1 Neutral	2.785
EMP.BKU.10	Küver Ünitesi Service Plate Unit	800	790	850/1350	75	0.8			700
EMP.BKU.10.AH	Küver Ünitesi (Ahşap Dekorlu) Service Plate Unit (Wooden Decorated)	800	790	850/1350	75	0.8			835



EMP.BKU.10.AH

Türkçe

BENMARİ VE NÖTR SERVİS ÜNİTELERİ

- Termostatik kumanda.
- 220 V 50 Hz enerji.
- Paslanmaz çelik havuz.
- Su tahliye vanası.
- Aydınlatma Sistemi.
- Opsiyonel ön ahşap giydirme.
- Paslanmaz çelik gövde.

*Standart üretimimizde küvet bulunmamaktadır.

English

BAIN MARIE AND NEUTRAL SERVICE UNITS

- Thermostatic control.
- Power:220 V 50 Hz
- Stainless steel well.
- Water drainage valve.
- Lightening system.
- Optional wooden front surface.
- Stainless steel body.

*Standart product does not have containers.

Renk Seçenekleri
Color Options



1 Koyu Eskiştirme
Dark Brown

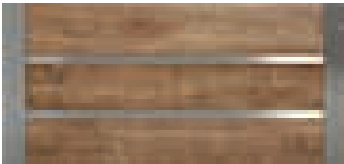

2 Açık Eskiştirme
Light Brown



3 Venge
Venge



4 Mahon
Rusty

Düz Camlı Servis Üniteleri Flat Glass Service Units

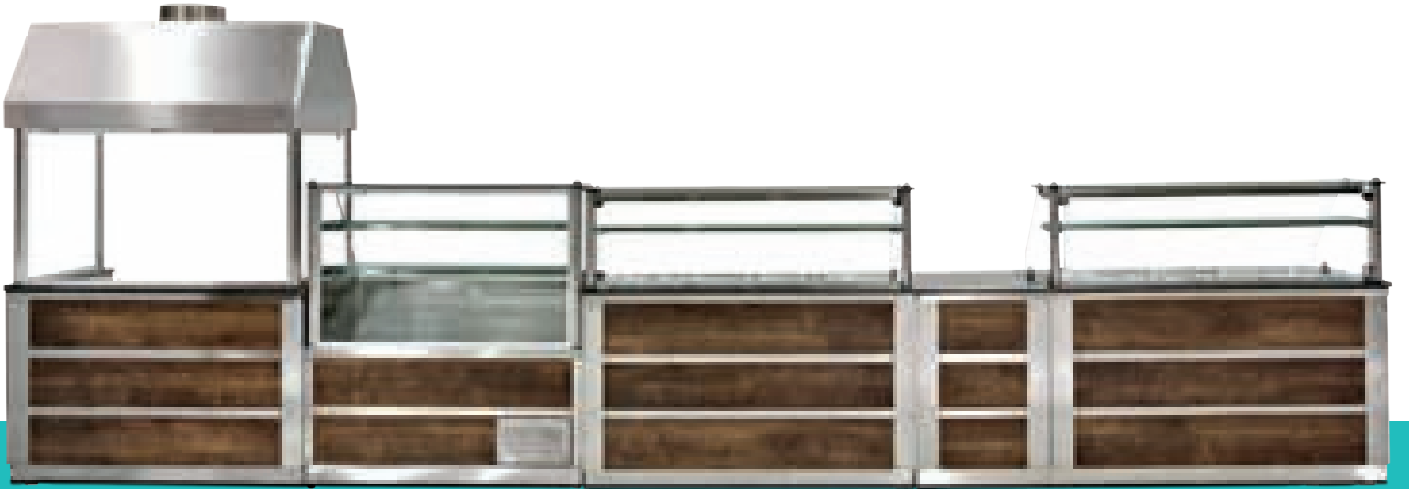

Renk Seçenekleri
Color Options



1 Koyu Eskiştirme
Dark Brown



2 Açık Eskiştirme
Light Brown



3 Venge
Venge



4 Mahon
Rusty

Bombe Camlı Servis Üniteleri
Convex Glass Service Units



Renk Seçenekleri
Color Options



1 Koyu Eskitme
Dark Brown



2 Açık Eskitme
Light Brown



3 Venge
Venge



4 Mahon
Rusty

Benmari Servis Üniteleri
Bain marie Service Units



Kod Code	Ürün Adı Description	Ebatlar Dimension mm			Ağırlık Weight kg	Net Net m³	Güç Power kw	Kapasite Capacity	Fiyatı Price Euro
		a	b	c					
EMP.BEH.05	Benmari Servis Ünitesi Bain marie Service Units	800x790x850			40	0.55	2.7	2x1/1 GN	1.050
EMP.BEH.10	Benmari Servis Ünitesi Bain marie Service Units	1250x790x850			67	0.8	2.7	3x1/1 GN	1.150
EMP.BEH.30	Benmari Servis Ünitesi Bain marie Service Units	1500x790x850			79	0.95	2.7	4x1/1 GN	1.365
EMP.BEH.50	Benmari Servis Ünitesi Bain marie Service Units	1800x790x850			95	1.2	4.3	5x1/1 GN	1.900
EMP.BEH.70	Benmari Servis Ünitesi Bain marie Service Units	2100x790x850			157	1.3	5.4	6x1/1 GN	2.150

Türkçe

BENMARİLER

- Termostatik kumanda.
- 220 V 50 Hz enerji.
- Paslanmaz çelik havuz.
- Su tahliye vanası.
- Led aydınlatma.
- Opsiyonel ön ahşap giydirme.
- Paslanmaz çelik gövde.

*Standart üretimimizde küvet bulunmamaktadır.

English

BAIN MARIES

- Thermostatic control.
- Power:220 V 50 Hz
- Stainless steel well.
- Water drainage valve.
- Led lightining.
- Optional wooden front surface.
- Stainless steel body.

*Standart product does not have containers.



Ahşap Dekor
Wooden Decorated

Üst Raf Grup
Farkı
Top Shelf Group

Tepsi Kaydırma
Standı
Tray Sliding Stand

Bombe Cam
Convex Glass

Granit Tabla
Granit Table



Renk Seçenekleri
Color Options



1 Koyu Eskiştirme
Dark Brown

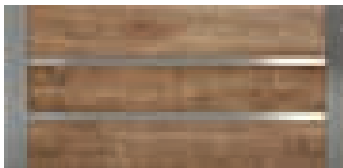

2 Açık Eskiştirme
Light Brown



3 Venge
Venge



4 Mahon
Rusty

Benmari Servis Ünite Aksesuarları

Bain marie Service Unit Accessories

Kod Code	Ürün Adı Description	Fiyatı Price Euro
EMP.BEH.05.AD	Ahşap Dekor Farkı (EMP.BEH.05) Wooden Decorated (EMP.BEH.05)	130
EMP.BEH.10.AD	Ahşap Dekor Farkı (EMP.BEH.10) Wooden Decorated (EMP.BEH.10)	210
EMP.BEH.30.AD	Ahşap Dekor Farkı (EMP.BEH.30) Wooden Decorated (EMP.BEH.30)	245
EMP.BEH.50.AD	Ahşap Dekor Farkı (EMP.BEH.50) Wooden Decorated (EMP.BEH.50)	285
EMP.BEH.70.AD	Ahşap Dekor Farkı (EMP.BEH.70) Wooden Decorated (EMP.BEH.70)	330

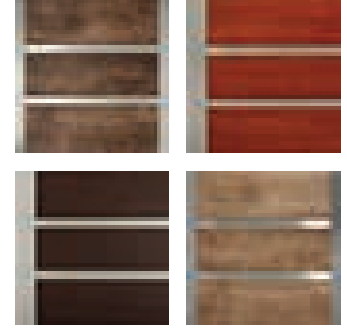

Kod Code	Ürün Adı Description	Ebatlar Dimension mm			Fiyatı Price Euro
		a	b	c	
EMP.BEH.05.USC.Y	Üst Raf Grup Farkı - Yarım Cam (EMP.BEH.05) Top Shelf Group Difference - Half Glass (EMP.BEH.05)	800	440	375	370
EMP.BEH.10.USC.Y	Üst Raf Grup Farkı - Yarım Cam (EMP.BEH.10) Top Shelf Group Difference - Half Glass (EMP.BEH.10)	1250	440	375	400
EMP.BEH.30.USC.Y	Üst Raf Grup Farkı - Yarım Cam (EMP.BEH.30) Top Shelf Group Difference - Half Glass (EMP.BEH.30)	1500	440	375	430
EMP.BEH.50.USC.Y	Üst Raf Grup Farkı - Yarım Cam (EMP.BEH.50) Top Shelf Group Difference - Half Glass (EMP.BEH.50)	1800	440	375	630
EMP.BEH.70.USC.Y	Üst Raf Grup Farkı - Yarım Cam (EMP.BEH.70) Top Shelf Group Difference - Half Glass (EMP.BEH.70)	2100	440	375	700



Kod Code	Ürün Adı Description	Ebatlar Dimension mm			Fiyatı Price Euro
		a	b	c	
EMP.BEH.05.USC.T	Üst Raf Grup Farkı - Tam Cam (EMP.BEH.05) Top Shelf Group Difference - Full Glass (EMP.BEH.05)	800	440	375	370
EMP.BEH.10.USC.T	Üst Raf Grup Farkı - Tam Cam (EMP.BEH.10) Top Shelf Group Difference - Full Glass (EMP.BEH.10)	1250	440	375	400
EMP.BEH.30.USC.T	Üst Raf Grup Farkı - Tam Cam (EMP.BEH.30) Top Shelf Group Difference - Full Glass (EMP.BEH.30)	1500	440	375	430
EMP.BEH.50.USC.T	Üst Raf Grup Farkı - Tam Cam (EMP.BEH.50) Top Shelf Group Difference - Full Glass (EMP.BEH.50)	1800	440	375	630
EMP.BEH.70.USC.T	Üst Raf Grup Farkı - Tam Cam (EMP.BEH.70) Top Shelf Group Difference - Full Glass (EMP.BEH.70)	2100	440	375	700



BEH.30+USC+AD+GT



BEH.30+AD+BC+GT

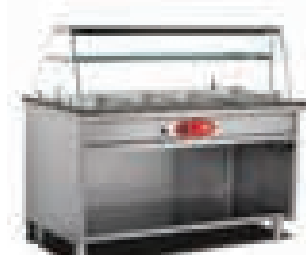

BEH.30+AD+BC+GT



BEH.30+AD+USC+GT

Benmari Servis Ünite Aksesuarları
Bain marie Service Unit Accessories

Kod Code	Ürün Adı Description	Ebatlar Dimension mm			Fiyatı Price Euro
		a	b	c	
EMP.BEH.05.BC.Y	Bombe Cam Farkı - Yarım Cam (EMP.BEH.05) Convex Glass Difference - Half Glass (EMP.BEH.05)	800x665x440			370
EMP.BEH.10.BC.Y	Bombe Cam Farkı - Yarım Cam (EMP.BEH.10) Convex Glass Difference - Half Glass (EMP.BEH.10)	1250x665x440			400
EMP.BEH.30.BC.Y	Bombe Cam Farkı - Yarım Cam (EMP.BEH.30) Convex Glass Difference - Half Glass (EMP.BEH.30)	1500x665x440			430
EMP.BEH.50.BC.Y	Bombe Cam Farkı - Yarım Cam (EMP.BEH.50) Convex Glass Difference - Half Glass (EMP.BEH.50)	1800x665x440			630
EMP.BEH.70.BC.Y	Bombe Cam Farkı - Yarım Cam (EMP.BEH.70) Convex Glass Difference - Half Glass (EMP.BEH.70)	2100x665x440			700



Kod Code	Ürün Adı Description	Ebatlar Dimension mm			Fiyatı Price Euro
		a	b	c	
EMP.BEH.05.BC.T	Bombe Cam Farkı - Tam Cam (EMP.BEH.05) Convex Glass Difference - Full Glass (EMP.BEH.05)	800x665x440			370
EMP.BEH.10.BC.T	Bombe Cam Farkı - Tam Cam (EMP.BEH.10) Convex Glass Difference - Full Glass (EMP.BEH.10)	1250x665x440			400
EMP.BEH.30.BC.T	Bombe Cam Farkı - Tam Cam (EMP.BEH.30) Convex Glass Difference - Full Glass (EMP.BEH.30)	1500x665x440			430
EMP.BEH.50.BC.T	Bombe Cam Farkı - Tam Cam (EMP.BEH.50) Convex Glass Difference - Full Glass (EMP.BEH.50)	1800x665x440			630
EMP.BEH.70.BC.T	Bombe Cam Farkı - Tam Cam (EMP.BEH.70) Convex Glass Difference - Full Glass (EMP.BEH.70)	2100x665x440			700

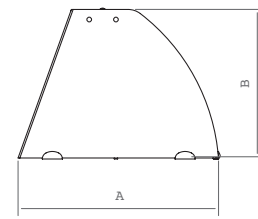

Bombe Cam
Convex Glass

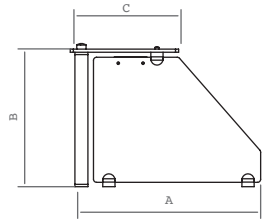

Düz Cam
Flat Glass

Benmari Servis Ünite Aksesuarları
Bain marie Service Unit Accessories

Kod Code	Ürün Adı Description	Fiyatı Price Euro
EMP.BEH.05.TK	Tepsi Kaydırma Standı Farkı (EMP.BEH.05) Tray Sliding Stand Difference (EMP.BEH.05)	210
EMP.BEH.10.TK	Tepsi Kaydırma Standı Farkı (EMP.BEH.10) Tray Sliding Stand Difference (EMP.BEH.10)	265
EMP.BEH.30.TK	Tepsi Kaydırma Standı Farkı (EMP.BEH.30) Tray Sliding Stand Difference (EMP.BEH.30)	290
EMP.BEH.50.TK	Tepsi Kaydırma Standı Farkı (EMP.BEH.50) Tray Sliding Stand Difference (EMP.BEH.50)	340
EMP.BEH.70.TK	Tepsi Kaydırma Standı Farkı (EMP.BEH.70) Tray Sliding Stand Difference (EMP.BEH.70)	420



Kod Code	Ürün Adı Description	Fiyatı Price Euro
EMP.BEH.05.GT	Granit Tabla Farkı (EMP.BEH.05) Granit Table Difference (EMP.BEH.05)	350
EMP.BEH.10.GT	Granit Tabla Farkı (EMP.BEH.10) Granit Table Difference (EMP.BEH.10)	475
EMP.BEH.30.GT	Granit Tabla Farkı (EMP.BEH.30) Granit Table Difference (EMP.BEH.30)	550
EMP.BEH.50.GT	Granit Tabla Farkı (EMP.BEH.50) Granit Table Difference (EMP.BEH.50)	650
EMP.BEH.70.GT	Granit Tabla Farkı (EMP.BEH.70) Granit Table Difference (EMP.BEH.70)	760



Standart granit: Star galaxy
Standard granite: Star galaxy

Soğuk Servis Üniteleri (Buzdolaplı) Cold Service Units (Refrigerated)



Kod Code	Ürün Adı Description	Ebatlar Dimension mm			Ağırlık Weight kg	Net Net m³	Güç Power kw	Kapasite Capacity	Fiyatı Price Euro
		a	b	c					
EMP.BSS.20	Soğuk Servis Ünitesi - Buzdolaplı Cold Service Unit - Refrigerated	1250x790x850			86	0.8	0.35	3x1/1 GN	1.680
EMP.BSS.40	Soğuk Servis Ünitesi - Buzdolaplı Cold Service Unit - Refrigerated	1500x790x850			100	1	0.45	4x1/1 GN	2.000
EMP.BSS.60	Soğuk Servis Ünitesi - Buzdolaplı Cold Service Unit - Refrigerated	2000x790x850			120	1.2	0.45	5x1/1 GN	2.250
EMP.BSS.80	Soğuk Servis Ünitesi - Buzdolaplı Cold Service Unit - Refrigerated	2555x790x850			140	1.68	0.5	6x1/1 GN	2.950

Türkçe

SOĞUK SERVİS ÜNİTELERİ (BUZDOLAPLI)

- Çalışma aralığı; +0 °C , + 5 °C (tropikal 43° C)
- 220 V-230 V -1 +N -50 60 Hz elektrik gücü.
- EMP.BSS.20 için 134A diğer modeller için 404A soğutucu gaz.
- 40 kg/m3 yoğunluk.
- Elektronik, sıcaklık ve defrost kontrollü gösterge.
- Defrost esnasında otomatik su buharlaştırma.
- Sökülebilir havalandırılmalı kompresör.
- Fanlı soğutma.
- 48 mm kalınlığında "ozon dostu" poliüretan izolasyon.
- 45 derecede sabit kendiliğinden kapanan kapılar.
- Alüminyum paneli,bakır borulu evaporatör.
- Ayarlanabilir , paslanmaz çelik raf yuvaları,plastik kaplama iç raf.
- Opsiyonel ön ahşap giydirme.
- Led aydınlatma.
- Paslanmaz çelik gövde.

*Standart üretimimizde küvet bulunmamaktadır.

English

COLD SERVICE UNITS (REFRIGERATED)

- Working temperature; 0° C , + 5° C (at ambient temp. 43° C)
- 220 V-230 V -1 +N -50 60 Hz electrical power.
- EMP.BSS.20 134A, for other models 404 A refrigerant gas.
- 40 kg/m3 density.
- Electronic temperature and defrosting control and display.
- Automatic evaporation of water during defrosting.
- Removable,conditioning compressor.
- Cooling with fan.
- "Ozone-friendly" 48 mm thickness polyurethane isolation.
- Self closing doors.
- Copper tube evaporator with aluminum fins.
- Adjustable,stainless steel shelf housing,plastic coated shelves.
- Optional wooden front surface.
- Led lightning.
- Stainless steel body.

*Standart product does not have containers.

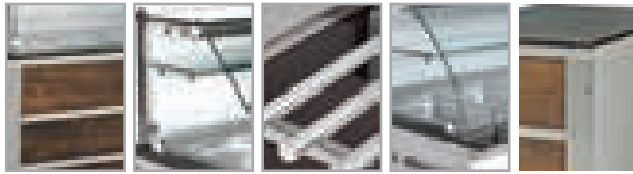

Ahşap Dekor
Wooden Decorated

Üst Raf Grup
Farkı
Top Shelf Group

Tepsi Kaydırma
Standı
Tray Sliding Stand

Bombe Cam
Convex Glass

Granit Tabla
Granit Table



R-290 Soğutucu Gaz Tipi için %3 fiyat farkı ekleyiniz.
Please add %3 price difference for R-290 refrigerant gas.

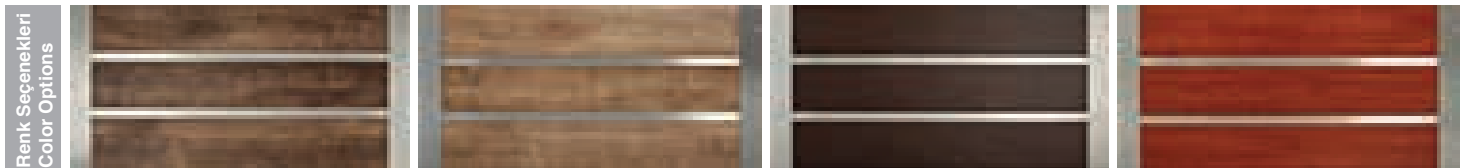

Renk Seçenekleri
Color Options

1 Koyu Eskitme
Dark Brown

2 Açık Eskitme
Light Brown

3 Venge
Venge

4 Mahon
Rusty

Soğuk Servis Ünite Aksesuarları
Cold Service Unit Accessories

Kod Code	Ürün Adı Description	Fiyatı Price Euro
EMP.BSS.20.AD	Ahşap Dekor Farkı (EMP.BSS.20) Wooden Decorated (EMP.BSS.20)	210
EMP.BSS.40.AD	Ahşap Dekor Farkı (EMP.BSS.40) Wooden Decorated (EMP.BSS.40)	245
EMP.BSS.60.AD	Ahşap Dekor Farkı (EMP.BSS.60) Wooden Decorated (EMP.BSS.60)	330
EMP.BSS.80.AD	Ahşap Dekor Farkı (EMP.BSS.80) Wooden Decorated (EMP.BSS.80)	420

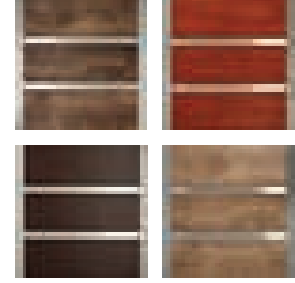

Kod Code	Ürün Adı Description	Ebatlar Dimension mm			Fiyatı Price Euro
		a	b	c	
EMP.BSS.20.USC.Y	Üst Raf Grup Farkı - Yarım Cam (EMP.BSS.20) Top Shelf Group Difference - Half Glass (EMP.BSS.20)	1250	440	375	400
EMP.BSS.40.USC.Y	Üst Raf Grup Farkı - Yarım Cam (EMP.BSS.40) Top Shelf Group Difference - Half Glass (EMP.BSS.40)	1500	440	375	430
EMP.BSS.60.USC.Y	Üst Raf Grup Farkı - Yarım Cam (EMP.BSS.60) Top Shelf Group Difference - Half Glass (EMP.BSS.60)	2000	440	375	700
EMP.BSS.80.USC.Y	Üst Raf Grup Farkı - Yarım Cam (EMP.BSS.80) Top Shelf Group Difference - Half Glass (EMP.BSS.80)	2550	440	375	830



Kod Code	Ürün Adı Description	Ebatlar Dimension mm			Fiyatı Price Euro
		a	b	c	
EMP.BSS.20.USC.T	Üst Raf Grup Farkı - Tam Cam (EMP.BSS.20) Top Shelf Group Difference - Full Glass (EMP.BSS.20)	1250	440	375	400
EMP.BSS.40.USC.T	Üst Raf Grup Farkı - Tam Cam (EMP.BSS.40) Top Shelf Group Difference - Full Glass (EMP.BSS.40)	1500	440	375	430
EMP.BSS.60.USC.T	Üst Raf Grup Farkı - Tam Cam (EMP.BSS.60) Top Shelf Group Difference - Full Glass (EMP.BSS.60)	2000	440	375	700
EMP.BSS.80.USC.T	Üst Raf Grup Farkı - Tam Cam (EMP.BSS.80) Top Shelf Group Difference - Full Glass (EMP.BSS.80)	2550	440	375	830



BSS.40+USC+AD+GT



BSS.40+AD+BC+GT



BSS.40+AD+BC+GT



BSS.40+AD+GT+USC

Soğuk Servis Ünite Aksesuarları
Cold Service Unit Accessories

Kod Code	Ürün Adı Description	Ebatlar Dimension mm			Fiyatı Price Euro
		a	b	c	
EMP.BSS.20.BC.Y	Bombe Cam Farkı - Yarım Cam (EMP.BSS.20) Convex Glass Difference - Half Glass (EMP.BSS.20)	1250	665	440	400
EMP.BSS.40.BC.Y	Bombe Cam Farkı - Yarım Cam (EMP.BSS.40) Convex Glass Difference - Half Glass (EMP.BSS.40)	1500	665	440	430
EMP.BSS.60.BC.Y	Bombe Cam Farkı - Yarım Cam (EMP.BSS.60) Convex Glass Difference - Half Glass (EMP.BSS.60)	2000	665	440	700
EMP.BSS.80.BC.Y	Bombe Cam Farkı - Yarım Cam (EMP.BSS.80) Convex Glass Difference - Half Glass (EMP.BSS.80)	2550	665	440	830



Kod Code	Ürün Adı Description	Ebatlar Dimension mm			Fiyatı Price Euro
		a	b	c	
EMP.BSS.20.BC.T	Bombe Cam Farkı - Tam Cam (EMP.BSS.20) Convex Glass Difference - Full Glass (EMP.BSS.20)	1250	665	440	400
EMP.BSS.40.BC.T	Bombe Cam Farkı - Tam Cam (EMP.BSS.40) Convex Glass Difference - Full Glass (EMP.BSS.40)	1500	665	440	430
EMP.BSS.60.BC.T	Bombe Cam Farkı - Tam Cam (EMP.BSS.60) Convex Glass Difference - Full Glass (EMP.BSS.60)	2000	665	440	700
EMP.BSS.80.BC.T	Bombe Cam Farkı - Tam Cam (EMP.BSS.80) Convex Glass Difference - Full Glass (EMP.BSS.80)	2550	665	440	830



Kod Code	Ürün Adı Description	Fiyatı Price Euro
EMP.BSS.20.TK	Tepsi Kaydırma Standı Farkı (EMP.BSS.20) Tray Sliding Stand Difference (EMP.BSS.20)	265
EMP.BSS.40.TK	Tepsi Kaydırma Standı Farkı (EMP.BSS.40) Tray Sliding Stand Difference (EMP.BSS.40)	290
EMP.BSS.60.TK	Tepsi Kaydırma Standı Farkı (EMP.BSS.60) Tray Sliding Stand Difference (EMP.BSS.60)	420
EMP.BSS.80.TK	Tepsi Kaydırma Standı Farkı (EMP.BSS.80) Tray Sliding Stand Difference (EMP.BSS.80)	550



Kod Code	Ürün Adı Description	Fiyatı Price Euro
EMP.BSS.20.GT	Granit Tabla Farkı (EMP.BSS.20) Granit Table Difference (EMP.BSS.20)	475
EMP.BSS.40.GT	Granit Tabla Farkı (EMP.BSS.40) Granit Table Difference (EMP.BSS.40)	550
EMP.BSS.60.GT	Granit Tabla Farkı (EMP.BSS.60) Granit Table Difference (EMP.BSS.60)	760
EMP.BSS.80.GT	Granit Tabla Farkı (EMP.BSS.80) Granit Table Difference (EMP.BSS.80)	920

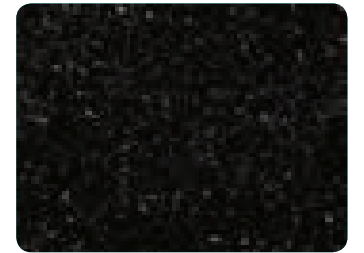

Standart granit: Star galaxy
Standard granite: Star galaxy

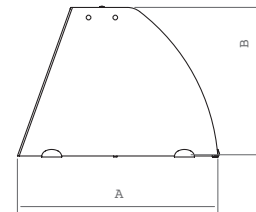

Bombe Cam
Convex Glass

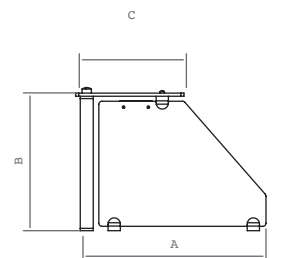

Düz Cam
Flat Glass

Soğuk Servis Üniteleri
Cold Service Units



Kod Code	Ürün Adı Description	Ebatlar Dimension mm			Ağırlık Weight kg	Net Net m³	Güç Power kw	Kapasite Capacity	Fiyatı Price Euro
		a	b	c					
EMP.BSSD.10S	Soğuk Servis Ünitesi Cold Service Unit	1500x790x850			86	0.8	0.45	3x1/1 GN	2.000
EMP.BSSD.50S	Soğuk Servis Ünitesi Cold Service Unit	2000x790x850			100	1	0.45	4x1/1 GN	2.300
EMP.BSSD.90S	Soğuk Servis Ünitesi Cold Service Unit	2550x790x850			120	1.68	0.50	5x1/1 GN	2.950

Türkçe

SOĞUK SERVİS ÜNİTELERİ

- Çalışma aralığı; +0 ° C , + 5 ° C (tropikal 43° C)
- 220 V-230 V -1 +N -50 60 Hz elektrik gücü.
- 404 A soğutucu gaz.
- 40 kg/m3 yoğunluk.
- Elektronik, sıcaklık ve defrost kontrollü gösterge.
- Defrost esnasında otomatik su buharlaştırma.
- Sökülebilir havalandırılmalı kompresör.
- Fanlı soğutma.
- 48 mm kalınlığında "ozon dostu" poliüretan izolasyon.
- 45 derecede sabit kendiliğinden kapanan kapılar.
- Alüminyum panelli, bakır borulu evaporatör.
- Ayarlanabilir , paslanmaz çelik raf yuvaları, plastik kaplama iç raf.
- Opsiyonel ön ahşap giydirme.
- Led aydınlatma.
- Paslanmaz çelik gövde.

*Standart üretimimizde küvet bulunmamaktadır.

English

COLD SERVICE UNITS

- Working temperature; 0° C , + 5° C (at ambient temp. 43° C)
- 220 V-230 V -1 +N -50 60 Hz electrical power.
- 404 A refrigerant gas.
- 40 kg/m3 density.
- Electronic temperature and defrosting control and display.
- Automatic evaporation of water during defrosting.
- Removable, conditioning compressor.
- Cooling with fan.
- "Ozone-friendly" 48 mm thickness polyurethane isolation.
- Self closing doors.
- Copper tube evaporator with aluminum fins.
- Adjustable, stainless steel shelf housing, plastic coated shelves.
- Optional wooden front surface.
- Led lighting.
- Stainless steel body.

*Standart product does not have containers.

R-290 Soğutucu Gaz Tipi için %3 fiyat farkı ekleyiniz.
Please add %3 price difference for R-290 refrigerant gas.



Ahşap Dekor
Wooden Decorated

Üst Raf Grup
Farkı
Top Shelf Group

Tepsi Kaydırma
Standı
Tray Sliding Stand

Bombe Cam
Convex Glass

Granit Tabla
Granit Table



Renk Seçenekleri
Color Options



1 Koyu Eski
Dark Brown

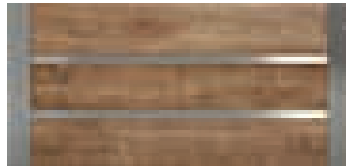

2 Açık Eski
Light Brown

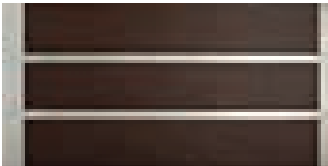

3 Venge
Venge



4 Mahon
Rusty

Soğuk Servis Ünite Aksesuarları
Cold Service Unit Accessories

Kod Code	Ürün Adı Description	Fiyatı Price Euro
EMP.BSSD.10S.AD	Ahşap Dekor Farkı (EMP.BSSD.10S) Wooden Decorated (EMP.BSSD.10S)	245
EMP.BSSD.50S.AD	Ahşap Dekor Farkı (EMP.BSSD.50S) Wooden Decorated (EMP.BSSD.50S)	330
EMP.BSSD.90S.AD	Ahşap Dekor Farkı (EMP.BSSD.90S) Wooden Decorated (EMP.BSSD.90S)	420

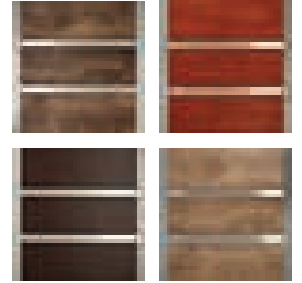

Kod Code	Ürün Adı Description	Ebatlar Dimension mm			Fiyatı Price Euro
		a	b	c	
EMP.BSSD.10S.USC.Y	Üst Raf Grup Farkı - Yarım Cam (EMP.BSSD.10S) Top Shelf Group Difference - Half Glass (EMP.BSSD.10S)	1100x440x375			400
EMP.BSSD.50S.USC.Y	Üst Raf Grup Farkı - Yarım Cam (EMP.BSSD.50S) Top Shelf Group Difference - Half Glass (EMP.BSSD.50S)	1600x440x375			430
EMP.BSSD.90S.USC.Y	Üst Raf Grup Farkı - Yarım Cam (EMP.BSSD.90S) Top Shelf Group Difference - Half Glass (EMP.BSSD.90S)	2150x440x375			700



Kod Code	Ürün Adı Description	Ebatlar Dimension mm			Fiyatı Price Euro
		a	b	c	
EMP.BSSD.10S.USC.T	Üst Raf Grup Farkı - Tam Cam (EMP.BSSD.10S) Top Shelf Group Difference - Full Glass (EMP.BSSD.10S)	1100x440x375			400
EMP.BSSD.50S.USC.T	Üst Raf Grup Farkı - Tam Cam (EMP.BSSD.50S) Top Shelf Group Difference - Full Glass (EMP.BSSD.50S)	1600x440x375			430
EMP.BSSD.90S.USC.T	Üst Raf Grup Farkı - Tam Cam (EMP.BSSD.90S) Top Shelf Group Difference - Full Glass (EMP.BSSD.90S)	2150x440x375			700



Soğuk Servis Ünite Aksesuarları Cold Service Unit Accessories

Kod Code	Ürün Adı Description	Ebatlar Dimension mm			Fiyatı Price Euro
		a	b	c	
EMP.BSSD.10S.BC.Y	Bombe Cam Farkı - Yarım Cam (EMP.BSSD.10S) Convex Glass Difference - Half Glass (EMP.BSSD.10S)	1100	440	375	400
EMP.BSSD.50S.BC.Y	Bombe Cam Farkı - Yarım Cam (EMP.BSSD.50S) Convex Glass Difference - Half Glass (EMP.BSSD.50S)	1600	440	375	430
EMP.BSSD.90S.BC.Y	Bombe Cam Farkı - Yarım Cam (EMP.BSSD.90S) Convex Glass Difference - Half Glass (EMP.BSSD.90S)	2150	440	375	700



Kod Code	Ürün Adı Description	Ebatlar Dimension mm			Fiyatı Price Euro
		a	b	c	
EMP.BSSD.10S.BC.T	Bombe Cam Farkı - Tam Cam (EMP.BSSD.10S) Convex Glass Difference - Full Glass (EMP.BSSD.10S)	1100	440	375	400
EMP.BSSD.50S.BC.T	Bombe Cam Farkı - Tam Cam (EMP.BSSD.50S) Convex Glass Difference - Full Glass (EMP.BSSD.50S)	1600	440	375	430
EMP.BSSD.90S.BC.T	Bombe Cam Farkı - Tam Cam (EMP.BSSD.90S) Convex Glass Difference - Full Glass (EMP.BSSD.90S)	2150	440	375	700



Kod Code	Ürün Adı Description	Fiyatı Price Euro
EMP.BSSD.10S.TK	Tepsi Kaydırma Standı Farkı (EMP.BSSD.10S) Tray Sliding Stand Difference (EMP.BSSD.10S)	290
EMP.BSSD.50S.TK	Tepsi Kaydırma Standı Farkı (EMP.BSSD.50S) Tray Sliding Stand Difference (EMP.BSSD.50S)	420
EMP.BSSD.90S.TK	Tepsi Kaydırma Standı Farkı (EMP.BSSD.90S) Tray Sliding Stand Difference (EMP.BSSD.90S)	550



Kod Code	Ürün Adı Description	Fiyatı Price Euro
EMP.BSSD.10S.GT	Granit Tabla Farkı (EMP.BSSD.10S) Granit Table Difference (EMP.BSSD.10S)	550
EMP.BSSD.50S.GT	Granit Tabla Farkı (EMP.BSSD.50S) Granit Table Difference (EMP.BSSD.50S)	760
EMP.BSSD.90S.GT	Granit Tabla Farkı (EMP.BSSD.90S) Granit Table Difference (EMP.BSSD.90S)	920

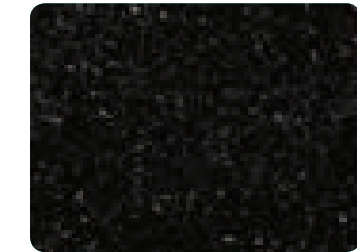

Standart granit: Star galaxy
Standard granite: Star galaxy

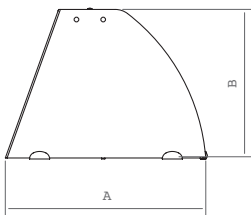

Bombe Cam
Convex Glass

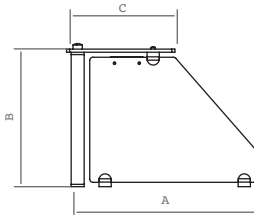

Düz Cam
Flat Glass



BSSD.50S+AD+USC+GT

Ocakbaşı
Display Type Grill

Kod Code	Ürün Adı Description	Ebatlar Dimension mm			Ağırlık Weight kg	Net Net m³	Kapasite Capacity Izgara / Grill (cm)	Fiyatı Price Euro
		a	b	c				
EMP.OCK.010	Ocakbaşı Display Type Grill	960x790x2100			225	1.95	80	3.150
EMP.OCK.020	Ocakbaşı Display Type Grill	1360x790x2100			290	2.75	120	3.450
EMP.OCK.030	Ocakbaşı Display Type Grill	1760x790x2100			355	3.55	160	4.100

Türkçe

OCAKBAŞI

- Ateş tuğlalı kömür ızgarası.
- Temperli cam.
- Filtreli davlumbaz.
- Çekmeceli kömür deposu.
- Paslanmaz çelik gövde.

English

DISPLAY TYPE GRILL

- Coal grill firebrick.
- Tempered glass.
- Hood with filter.
- Coal drawer.
- Stainless steel body.

**KÖMÜRLÜ IZGARA YERİNE LAVATAŞLI VEYA SULU IZGARA KOYABİLME OPSİYONU.
INSTEAD OF COAL GRILL, VAPOR GRILL OR LAVASTONE GRILL OPTION.**

KÖMÜRLÜ IZGARA FİYATA DAHİDİR.

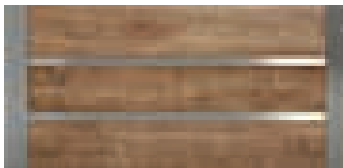
Renk Seçenekleri
Color Options1 Koyu Eskiştirme
Dark Brown2 Açık Eskiştirme
Light Brown3 Venge
Venge4 Mahon
Rusty

Ocakbaşı Aksesuarları
Display Type Grill Accessories

Kod Code	Ürün Adı Description	Fiyatı Price Euro
EMP.OCK.010.AD	Ahşap Dekor Farkı (EMP.OCK.010) Wooden Decorated (EMP.OCK.010)	185
EMP.OCK.020.AD	Ahşap Dekor Farkı (EMP.OCK.020) Wooden Decorated (EMP.OCK.020)	240
EMP.OCK.030.AD	Ahşap Dekor Farkı (EMP.OCK.030) Wooden Decorated (EMP.OCK.030)	315

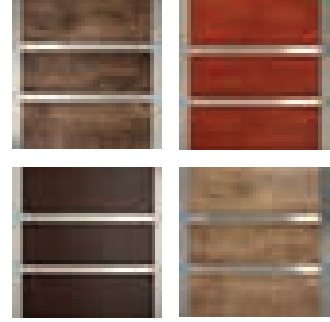

Kod Code	Ürün Adı Description	Fiyatı Price Euro
EMP.OCK.010.GT	Granit Tabla Farkı (EMP.OCK.010) Granit Table Difference (EMP.OCK.010)	185
EMP.OCK.020.GT	Granit Tabla Farkı (EMP.OCK.020) Granit Table Difference (EMP.OCK.020)	200
EMP.OCK.030.GT	Granit Tabla Farkı (EMP.OCK.030) Granit Table Difference (EMP.OCK.030)	230



Standart granit: Star galaxy
Standard granite: Star galaxy

Kod Code	Ürün Adı Description	Fiyatı Price Euro
EMP.OCK.010.BR	Bakır Davlumbaz Farkı (EMP.OCK.010) Granit Table Difference (EMP.OCK.010)	575
EMP.OCK.020.BR	Bakır Davlumbaz Farkı (EMP.OCK.020) Granit Table Difference (EMP.OCK.020)	800
EMP.OCK.030.BR	Bakır Davlumbaz Farkı (EMP.OCK.030) Granit Table Difference (EMP.OCK.030)	1.000

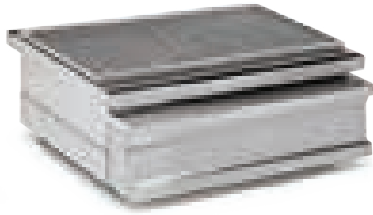

NEW**Teşhir Ürünleri**
Display Product**Kömürlü Izgara**
Charcoal Grill

Kod Code	Ürün Adı Description	Ebatlar Dimension mm			Ağırlık Weight kg	Net Net m ³	Fiyatı Price Euro
		a	b	c			
EMP.OCK.010-K	Kömürlü Izgara Charcoal Grill	800	730	290	20	0.16	600

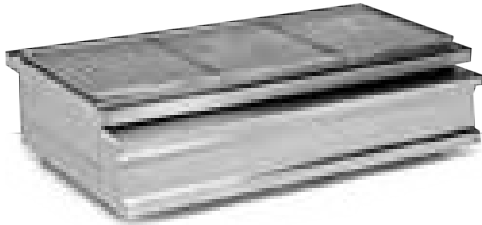

Kod Code	Ürün Adı Description	Ebatlar Dimension mm			Ağırlık Weight kg	Net Net m ³	Fiyatı Price Euro
		a	b	c			
EMP.OCK.020-K	Kömürlü Izgara Charcoal Grill	12000	730	290	30	0.25	750

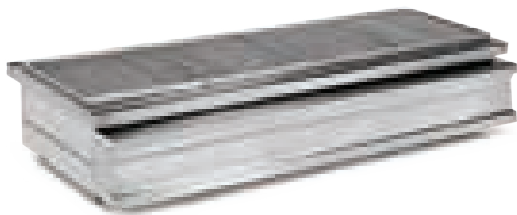

Kod Code	Ürün Adı Description	Ebatlar Dimension mm			Ağırlık Weight kg	Net Net m ³	Fiyatı Price Euro
		a	b	c			
EMP.OCK.030-K	Kömürlü Izgara Charcoal Grill	1600	730	290	40	0.33	950

Türkçe**KÖMÜRLÜ IZGARA**

- Ateş tuğlalı kömür ızgarası.
- Kül Haznesi.
- Paslanmaz çelik gövde.

English**CHARCOAL GRILL**

- Coal grill firebrick.
- Ash drawer.
- Stainless steel body.

Nötr Servis Üniteleri
Neutral Service Units



Kod Code	Ürün Adı Description	Ebatlar Dimension mm			Ağırlık Weight kg	Net Net m ²	Fiyatı Price Euro
		a	b	c			
EMP.NS.10	Nötr Servis Ünitesi Neutral Service Units	600x790x850			66	0.4	475
EMP.NS.30	Nötr Servis Ünitesi Neutral Service Units	900x790x850			70	0.6	525
EMP.NS.50	Nötr Servis Ünitesi Neutral Service Units	1150x790x850			85	0.8	630
EMP.NS.70	Nötr Servis Ünitesi Neutral Service Units	1500x790x850			95	1	730
EMP.NS.90	Nötr Servis Ünitesi Neutral Service Units	1800x790x850			105	1.2	850



EMP.NS.10+AD+GT

Türkçe

NÖTR SERVİS ÜNİTESİ

- Ayarlanabilir ayaklar.
- Opsiyonel ön ahşap giydirme.
- Led aydınlatma.
- Paslanmaz çelik gövde.

English

NEUTRAL SERVICE UNITS

- Adjustable feet.
- Optional wooden front surface.
- Led lightining.
- Stainless steel body.

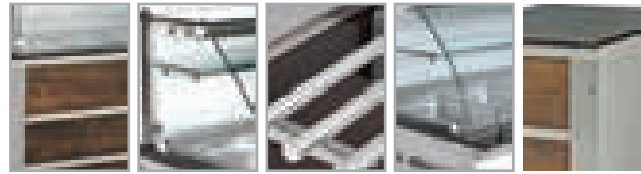

Ahşap Dekor
Wooden Decorated

Üst Raf Grup
Farkı
Top Shelf Group

Tepsi Kaydırma
Standı
Tray Sliding Stand

Bombe Cam
Convex Glass

Granit Tabla
Granit Table

Renk Seçenekleri
Color Options



1 Koyu Eskiştirme
Dark Brown

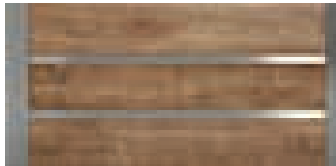

2 Açık Eskiştirme
Light Brown



3 Venge
Venge



4 Mahon
Rusty

Nötr Servis Ünite Aksesuarları
Neutral Service Unit Accessories

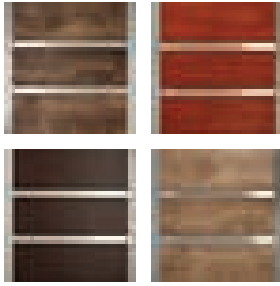

Kod Code	Ürün Adı Description	Fiyatı Price Euro
EMP.NS.10.AD	Ahşap Dekor Farkı (EMP.NS.10) Wooden Decorated (EMP.NS.10)	120
EMP.NS.30.AD	Ahşap Dekor Farkı (EMP.NS.30) Wooden Decorated (EMP.NS.30)	150
EMP.NS.50.AD	Ahşap Dekor Farkı (EMP.NS.50) Wooden Decorated (EMP.NS.50)	210
EMP.NS.70.AD	Ahşap Dekor Farkı (EMP.NS.70) Wooden Decorated (EMP.NS.70)	250
EMP.NS.90.AD	Ahşap Dekor Farkı (EMP.NS.90) Wooden Decorated (EMP.NS.90)	290



Kod Code	Ürün Adı Description	Ebatlar Dimension mm			Fiyatı Price Euro
		a	b	c	
EMP.NS.10.USC.Y	Üst Raf Grup Farkı - Yarım Cam (EMP.NS.10) Top Shelf Group Difference - Half Glass (EMP.NS.10)	600	440	375	315
EMP.NS.30.USC.Y	Üst Raf Grup Farkı - Yarım Cam (EMP.NS.30) Top Shelf Group Difference - Half Glass (EMP.NS.30)	900	440	375	370
EMP.NS.50.USC.Y	Üst Raf Grup Farkı - Yarım Cam (EMP.NS.50) Top Shelf Group Difference - Half Glass (EMP.NS.50)	1150	440	375	400
EMP.NS.70.USC.Y	Üst Raf Grup Farkı - Yarım Cam (EMP.NS.70) Top Shelf Group Difference - Half Glass (EMP.NS.70)	1500	440	375	430
EMP.NS.90.USC.Y	Üst Raf Grup Farkı - Yarım Cam (EMP.NS.90) Top Shelf Group Difference - Half Glass (EMP.NS.90)	1800	440	375	630



Kod Code	Ürün Adı Description	Ebatlar Dimension mm			Fiyatı Price Euro
		a	b	c	
EMP.NS.10.USC.T	Üst Raf Grup Farkı - Tam Cam (EMP.NS.10) Top Shelf Group Difference - Full Glass (EMP.NS.10)	600	440	375	315
EMP.NS.30.USC.T	Üst Raf Grup Farkı - Tam Cam (EMP.NS.30) Top Shelf Group Difference - Full Glass (EMP.NS.30)	900	440	375	370
EMP.NS.50.USC.T	Üst Raf Grup Farkı - Tam Cam (EMP.NS.50) Top Shelf Group Difference - Full Glass (EMP.NS.50)	1150	440	375	400
EMP.NS.70.USC.T	Üst Raf Grup Farkı - Tam Cam (EMP.NS.70) Top Shelf Group Difference - Full Glass (EMP.NS.70)	1500	440	375	430
EMP.NS.90.USC.T	Üst Raf Grup Farkı - Tam Cam (EMP.NS.90) Top Shelf Group Difference - Full Glass (EMP.NS.90)	1800	440	375	630

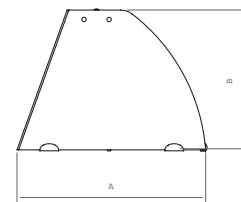

Bombe Cam
Convex Glass

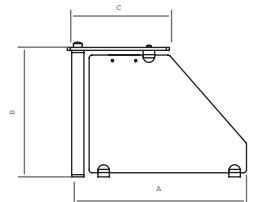

Düz Cam
Flat Glass

Nötr Servis Ünite Aksesuarları

Neutral Service Unit Accessories

Kod Code	Ürün Adı Description	Ebatlar Dimension mm			Fiyatı Price Euro
		a	b	c	
EMP.NS.10.BC.Y	Bombe Cam Farkı - Yarım Cam (EMP.NS.10) Convex Glass Difference - Half Glass (EMP.NS.10)	600	665	440	315
EMP.NS.30.BC.Y	Bombe Cam Farkı - Yarım Cam (EMP.NS.30) Convex Glass Difference - Half Glass (EMP.NS.30)	900	665	440	370
EMP.NS.50.BC.Y	Bombe Cam Farkı - Yarım Cam (EMP.NS.50) Convex Glass Difference - Half Glass (EMP.NS.50)	1150	665	440	400
EMP.NS.70.BC.Y	Bombe Cam Farkı - Yarım Cam (EMP.NS.70) Convex Glass Difference - Half Glass (EMP.NS.70)	1500	665	440	430
EMP.NS.90.BC.Y	Bombe Cam Farkı - Yarım Cam (EMP.NS.90) Convex Glass Difference - Half Glass (EMP.NS.90)	1800	665	440	630



Kod Code	Ürün Adı Description	Ebatlar Dimension mm			Fiyatı Price Euro
		a	b	c	
EMP.NS.10.BC.T	Bombe Cam Farkı - Tam Cam (EMP.NS.10) Convex Glass Difference - Full Glass (EMP.NS.10)	600	665	440	315
EMP.NS.30.BC.T	Bombe Cam Farkı - Tam Cam (EMP.NS.30) Convex Glass Difference - Full Glass (EMP.NS.30)	900	665	440	370
EMP.NS.50.BC.T	Bombe Cam Farkı - Tam Cam (EMP.NS.50) Convex Glass Difference - Full Glass (EMP.NS.50)	1150	665	440	400
EMP.NS.70.BC.T	Bombe Cam Farkı - Tam Cam (EMP.NS.70) Convex Glass Difference - Full Glass (EMP.NS.70)	1500	665	440	430
EMP.NS.90.BC.T	Bombe Cam Farkı - Tam Cam (EMP.NS.90) Convex Glass Difference - Full Glass (EMP.NS.90)	1800	665	440	630



Nötr Servis Ünite Aksesuarları
Neutral Service Unit Accessories

Kod Code	Ürün Adı Description	Fiyatı Price Euro
EMP.NS.10.TK	Tepsi Kaydırma Standı Farkı (EMP.NS.10) Tray Sliding Stand Difference (EMP.NS.10)	200
EMP.NS.30.TK	Tepsi Kaydırma Standı Farkı (EMP.NS.30) Tray Sliding Stand Difference (EMP.NS.30)	240
EMP.NS.50.TK	Tepsi Kaydırma Standı Farkı (EMP.NS.50) Tray Sliding Stand Difference (EMP.NS.50)	250
EMP.NS.70.TK	Tepsi Kaydırma Standı Farkı (EMP.NS.70) Tray Sliding Stand Difference (EMP.NS.70)	290
EMP.NS.90.TK	Tepsi Kaydırma Standı Farkı (EMP.NS.90) Tray Sliding Stand Difference (EMP.NS.90)	350



Kod Code	Ürün Adı Description	Fiyatı Price Euro
EMP.NS.10.GT	Granit Tabla Farkı (EMP.NS.10) Granit Table Difference (EMP.NS.10)	315
EMP.NS.30.GT	Granit Tabla Farkı (EMP.NS.30) Granit Table Difference (EMP.NS.30)	350
EMP.NS.50.GT	Granit Tabla Farkı (EMP.NS.50) Granit Table Difference (EMP.NS.50)	475
EMP.NS.70.GT	Granit Tabla Farkı (EMP.NS.70) Granit Table Difference (EMP.NS.70)	550
EMP.NS.90.GT	Granit Tabla Farkı (EMP.NS.90) Granit Table Difference (EMP.NS.90)	650

Standart granit: Star galaxy
Standard granite: Star galaxy

Köşe Tezgahı ve Küver Ünitesi Corner Service Table and Cutlery Unit



Tablo/Table



Kod Code	Ürün Adı Description	Ebatlar Dimension mm			Ağırlık Weight kg	Net Net m³	Fiyatı Price Euro
		a	b	c			
EMP.BKT.10	Köşe Tezgahı Corner Service Table	1400x790x850			75	0.9	790
EMP.BKU.10	Küver Ünitesi Cutlery Unit	800x790x850/1350			75	0.8	700

Türkçe

KÖŞE TEZGAHI VE KÜVER ÜNİTESİ

- Ayarlanabilir ayaklar.
- Opsiyonel ön ahşap giydirme.
- Paslanmaz çelik gövde.

*Standart üretimimizde küvet bulunmamaktadır.

English

CORNER SERVICE TABLE AND CUTLERY UNIT

- Adjustable feet.
- Optional wooden front surface.
- Stainless steel body.

*Standart product does not have containers.



Küver Ünitesi
Cutlery Unit

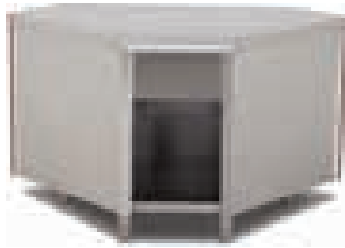

Köşe Tezgahı
Corner Service Table



Ahşap Dekor
Wooden Decorated

Tepsi Kaydırma
Standı
Tray Sliding Stand

Granit Tabla
Granit Table

Renk Seçenekleri
Color Options



1 Koyu Eskieme
Dark Brown

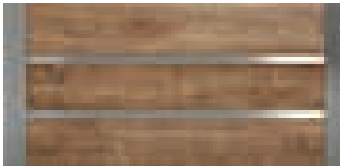

2 Açık Eskieme
Light Brown



3 Venge
Venge

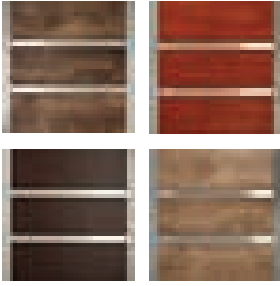

4 Mahon
Rusty

Köşe Tezgahı ve Küver Ünite Aksesuarları
Corner Service Table and Cutlery Unit Accessories

Kod Code	Ürün Adı Description	Fiyatı Price Euro
EMP.BKT.10.AD	Ahşap Dekor Farkı (EMP.BKT.10) Wooden Decorated (EMP.BKT.10)	245
EMP.BKU.10.AD	Ahşap Dekor Farkı (EMP.BKU.10) Wooden Decorated (EMP.BKU.10)	140



Kod Code	Ürün Adı Description	Fiyatı Price Euro
EMP.BKT.10.TK	Tepsi Kaydırma Standı Farkı (EMP.BKT.10) Tray Sliding Stand Difference (EMP.BKT.10)	315

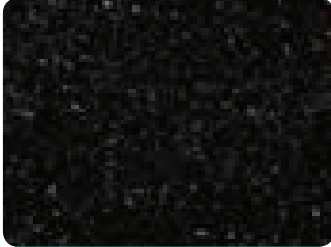

Kod Code	Ürün Adı Description	Fiyatı Price Euro
EMP.BKT.10.GT	Granit Tabla Farkı (EMP.BKT.10) Granit Table Difference (EMP.BKT.10)	550
EMP.BKU.10.GT	Granit Tabla Farkı (EMP.BKU.10) Granit Table Difference (EMP.BKU.10)	400

Standart granit: Star galaxy
Standard granite: Star galaxy



EMP.BKT.10+AD+GT



EMP.BKT.10+AD+GT

Merkür Et ve Meze Vitrinleri (Bombe Cam) Mercury Meat and Appetizer Showcases (Convex Glass)



Buğulanma yapmayan ön ısı cam.
Condensation blocker double glazing.

Kod Code	Ürün Adı Description	Ebatlar Dimension mm			Ağırlık Weight kg	Net Net m³	Motor Gücü Motor Power kw	Elektrik Gücü Electric Power kw	Soğ. Kap Cooling Cap. kw	Fiyatı Price Euro
		a	b	c						
EMP.MZ.100.A.BC	Merkür Et ve Meze Vitrini (Ahşap Dekorlu-Bombe Cam) Mercury Meat and Appetizer Showcase (Wooden Decorated-Convex Glass)	1000	750	1350	240	1.1	0.5	0.7	1.01	2.790
EMP.MZ.100.P.BC	Merkür Et ve Meze Vitrini (Paslanmaz Çelik-Bombe Cam) Mercury Meat and Appetizer Showcase (Stainless Steel-Convex Glass)	1000	750	1350	240	1.1	0.5	0.7	1.01	3.050
EMP.MZ.150.A.BC	Merkür Et ve Meze Vitrini (Ahşap Dekorlu-Bombe Cam) Mercury Meat and Appetizer Showcase (Wooden Decorated-Convex Glass)	1500	750	1350	296	1.4	0.5	0.8	1.08	3.300
EMP.MZ.150.P.BC	Merkür Et ve Meze Vitrini (Paslanmaz Çelik-Bombe Cam) Mercury Meat and Appetizer Showcase (Stainless Steel-Convex Glass)	1500	750	1350	296	1.4	0.5	0.8	1.08	3.625
EMP.MZ.200.A.BC	Merkür Et ve Meze Vitrini (Ahşap Dekorlu-Bombe Cam) Mercury Meat and Appetizer Showcase (Wooden Decorated-Convex Glass)	2000	750	1350	350	1.9	0.5+	0.98	1.73	3.900
EMP.MZ.200.P.BC	Merkür Et ve Meze Vitrini (Paslanmaz Çelik-Bombe Cam) Mercury Meat and Appetizer Showcase (Stainless Steel-Convex Glass)	2000	750	1350	350	1.9	0.5+	0.98	1.73	4.200



Türkçe

MERKÜR ET VE MEZE VİTRİNERİ (BOMBE CAM)

- Çalışma aralığı; +0° C, +8° C (tropikal 43° C)
- İçten motorlu soğutma uygulaması.
- Reyon altı depolama sistemi.
- Bombe camlı meze vitrinlerinde açılabilir ön cam.
- Statik soğutma.
- R-134 A soğutucu gaz.
- Led aydınlatma sistemi.
- 40 kg/m3 yoğunluk poliüretan izolasyon.
- Opsiyonel ahşap gövde.

English

MERCURY MEAT AND APPETIZER SHOWCASES (CONVEX GLASS)

- Working temperature; 0° C, +8° C (at ambient temp. 43° C)
- Interior engine refrigerating system.
- Under-set storage system.
- Lift up safety front glass, for convex glass showcase.
- Static cooling.
- R-134 A refrigerant gas.
- Led lighting system.
- 40 kg/m3 density polyurethane isolation.
- Optional wooden body colour.

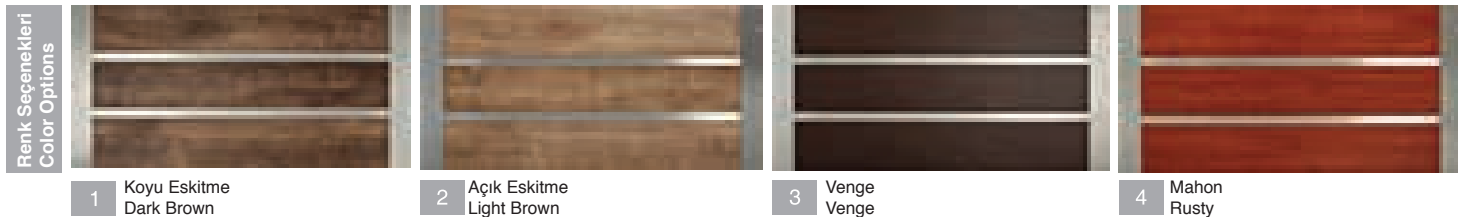
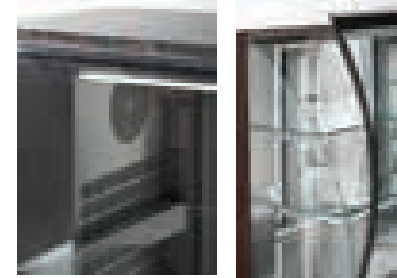
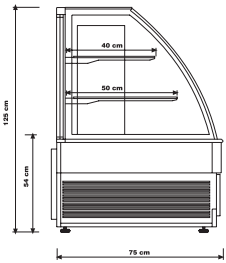



Merkür Et ve Meze Vitrinleri (Düz Cam)
Mercury Meat and Appetizer Showcases (Flat Glass)



Buğulanma yapmayan ön ısı cam.
Condensation blocker double glazing.

Kod Code	Ürün Adı Description	Ebatlar Dimension mm			Ağırlık Weight kg	Net Net m³	Motor Gücü Motor Power kw	Elektrik Gücü Electric Power kw	Soğ. Kap Cooling Cap. kw	Fiyatı Price Euro
		a	b	c						
EMP.MZ.100.A.DC	Merkür Et ve Meze Vitrini (Ahşap Dekorlu-Düz Cam) Mercury Meat and Appetizer Showcase (Wooden Decorated-Flat Glass)	1000x750x1350			240	1.1	0.5	0.7	1.01	2.790
EMP.MZ.100.P.DC	Merkür Et ve Meze Vitrini (Paslanmaz Çelik-Düz Cam) Mercury Meat and Appetizer Showcase (Stainless Steel-Flat Glass)	1000x750x1350			240	1.1	0.5	0.7	1.01	3.050
EMP.MZ.150.A.DC	Merkür Et ve Meze Vitrini (Ahşap Dekorlu-Düz Cam) Mercury Meat and Appetizer Showcase (Wooden Decorated-Flat Glass)	1500x750x1350			296	1.4	0.5	0.8	1.08	3.300
EMP.MZ.150.P.DC	Merkür Et ve Meze Vitrini (Paslanmaz Çelik-Düz Cam) Mercury Meat and Appetizer Showcase (Stainless Steel-Flat Glass)	1500x750x1350			296	1.4	0.5	0.8	1.08	3.625
EMP.MZ.200.A.DC	Et ve Meze Vitrini (Ahşap Dekorlu-Düz Cam) Mercury Meat and Appetizer Showcase (Wooden Decorated-Flat Glass)	2000x750x1350			350	1.9	0.5+	0.98	1.73	3.900
EMP.MZ.200.P.DC	Merkür Et ve Meze Vitrini (Paslanmaz Çelik-Düz Cam) Mercury Meat and Appetizer Showcase (Stainless Steel-Flat Glass)	2000x750x1350			350	1.9	0.5+	0.98	1.73	4.200

Türkçe

MERKÜR ET ve MEZE VİTRİNLERİ
(DÜZ CAM)

- Çalışma aralığı; +0° C, + 8° C (tropikal 43° C)
- İçten motorlu soğutma uygulaması.
- Reyon altı depolama sistemi.
- Statik soğutma.
- R-134 A soğutucu gaz.
- Led aydınlatma sistemi.
- 40 kg/m3 yoğunluk poliüretan izolasyon.
- Opsiyonel ahşap gövde.

English

MERCURY MEAT AND APPETIZER
SHOWCASES (FLAT GLASS)

- Working temperature; 0° C, + 8° C (at ambient temp. 43° C)
- Interior engined refrigerating system.
- Under-set storage system.
- Static cooling.
- R-134 A refrigerant gas.
- Led lighting system.
- 40 kg/m3 density polyurathane isolation.
- Optional wooden body colour.



Renk Seçenekleri
Color Options



1 Koyu EskiTme
Dark Brown

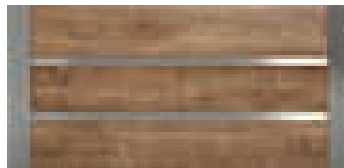

2 Açık EskiTme
Light Brown



3 Venge
Venge



4 Mahon
Rusty

Plüton Et ve Meze Teşhir Vitrinleri (Düz Camlı) Pluton Meat and Apettizer Showcase (Flat Glass)



Buğulanma yapmayan ön ısı cam.
Condensation blocker double glazing.

Kod Code	Ürün Adı Description	Ebatlar Dimension mm			Ağırlık Weight kg	Net Net m ³	Motor Gücü Motor Power kw	Elektrik Gücü Electric Power kw	Soğ. Kap Cooling Cap. kw	Fiyatı Price Euro
		a	b	c						
EMP.VT.D.100.S	Plüton Et ve Meze Teşhir Vitrinleri (Düz Camlı) Pluton Meat and Apettizer Showcase (Flat Glass)	1000	870	1350	172	1.1	0.5	0.98	1.73	2.900
EMP.VT.D.130.S	Plüton Et ve Meze Teşhir Vitrinleri (Düz Camlı) Pluton Meat and Apettizer Showcase (Flat Glass)	1300	870	1350	224	1.2	0.5	0.98	1.73	3.250
EMP.VT.D.160.S	Plüton Et ve Meze Teşhir Vitrinleri (Düz Camlı) Pluton Meat and Apettizer Showcase (Flat Glass)	1600	870	1350	255	1.5	0.5	0.98	1.73	3.450
EMP.VT.D.200.S	Plüton Et ve Meze Teşhir Vitrinleri (Düz Camlı) Pluton Meat and Apettizer Showcase (Flat Glass)	2000	870	1350	276	1.5	0.5	1.01	2.07	4.050

Türkçe

PLÜTON ET ve MEZE TEŞHİR VİTRİNLERİ (DÜZ CAMLI)

- Çalışma aralığı; +0° C, + 8° C (tropikal 43° C)
- İçten motorlu soğutma uygulaması.
- Reyon altı depolama sistemi.
- Fanlı soğutma.
- R-134 A soğutucu gaz.
- Led aydınlatma sistemi.
- 40 kg/m3 yoğunluk poliüretan izolasyon.
- Opsiyonel ahşap gövde.

English

PLUTON MEAT AND APETTIZER SHOWCASE (FLAT GLASS)

- Working temperature; 0° C, + 8° C (at ambient temp. 43° C)
- Interior engined refrigeration system.
- Under-set storage system.
- Cooling with fan.
- Refrigerant gas:R-134 A
- Led lighting system.
- 40 kg/m3 density polyurathane isolation.
- Optional wooden body colour.

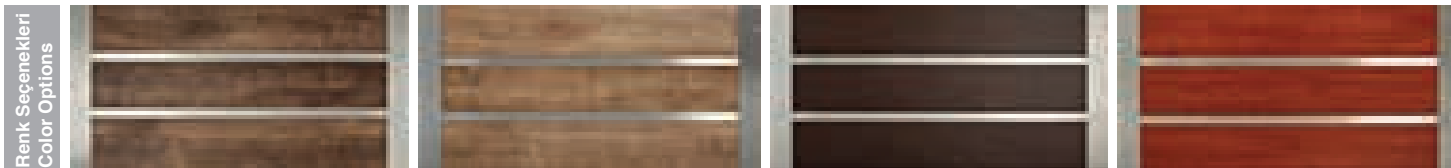

1 Koyu Eskieme
Dark Brown

2 Açık Eskieme
Light Brown

3 Venge
Venge

4 Mahon
Rusty

Plüton Et ve Meze Teşhir Vitrinleri (Bombe Camlı)
Pluton Meat and Apettizer Showcase (Convex Glass)



Buğulanma yapmayan ön ısı cam.
Condensation blocker double glazing.

Kod Code	Ürün Adı Description	Ebatlar Dimension mm			Ağırlık Weight kg	Net Net m ³	Motor Gücü Motor Power kw	Elektrik Gücü Electric Power kw	Soğ. Kap Cooling Cap. kw	Fiyatı Price Euro
		a	b	c						
EMP.VT.B.100.S	Plüton Et ve Meze Teşhir Vitrinleri (Bombe Camlı) Pluton Meat and Apettizer Showcase (Convex Glass)	1000	870	1350	172	1.1	0.5	0.98	1.73	2.900
EMP.VT.B.130.S	Plüton Et ve Meze Teşhir Vitrinleri (Bombe Camlı) Pluton Meat and Apettizer Showcase (Convex Glass)	1300	870	1350	224	1.2	0.5	0.98	1.73	3.250
EMP.VT.B.160.S	Plüton Et ve Meze Teşhir Vitrinleri (Bombe Camlı) Pluton Meat and Apettizer Showcase (Convex Glass)	1600	870	1350	255	1.5	0.5	0.98	1.73	3.450
EMP.VT.B.200.S	Plüton Et ve Meze Teşhir Vitrinleri (Bombe Camlı) Pluton Meat and Apettizer Showcase (Convex Glass)	2000	870	1350	276	1.5	0.5	1.01	2.07	4.050

Türkçe

PLÜTON ET VE MEZE TEŞHİR VİTRİNLERİ
(BOMBE CAMLI)

- Çalışma aralığı; +0° C, + 8° C (tropikal 43° C)
- İçten motorlu soğutma uygulaması.
- Reyon altı depolama sistemi.
- Açılabilir ön cam.
- Fanlı soğutma.
- R-134 A soğutucu gaz.
- Led aydınlatma sistemi.
- 40 kg/m³ yoğunluk poliüretan izolasyon.
- Opsiyonel ahşap gövde.

English

PLUTON MEAT AND APETTIZER SHOWCASE
(CONVEX GLASS)

- Working temperature; 0° C, + 8° C (at ambient temp. 43° C)
- Interior engined refrigeration system.
- Under-set storage system.
- Lift up safety front glass.
- Cooling with fan.
- Refrigerant gas:R-134 A
- Led lighting system.
- 40 kg/m³ density polyurathane isolation.
- Optional wooden body colour.



Renk Seçenekleri
Color Options

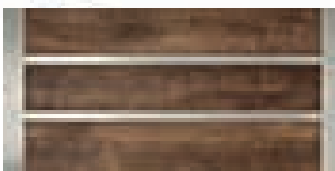

1 Koyu EskiTme
Dark Brown

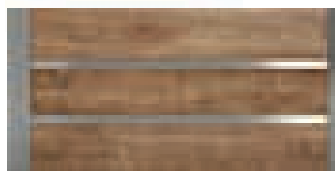

2 Açık EskiTme
Light Brown



3 Venge
Venge



4 Mahon
Rusty

Venüs Pasta Vitrinleri Venus Pastry Showcase



Buğulanma yapmayan ön ısı cam.
Condensation blocker double glazing.

Kod Code	Ürün Adı Description	Ebatlar Dimension mm			Ağırlık Weight kg	Net Net m³	Motor Gücü Motor Power kw	Elektrik Gücü Electric Power kw	Soğ. Kap Cooling Cap. kw	Fiyatı Price Euro
		a	b	c						
EMP.BC.100.S	Venüs Pasta Vitrini (Soğutmalı) Venus Pastry Showcase (Cooling)	1000	750	1350	172	1.01	0.5	0.7	1.15	2.730
EMP.BC.100.N	Venüs Pasta Vitrini (Nötr) Venus Pastry Showcase (Neutral)	1000	750	1350	158	1.01				2.300
EMP.BC.100.I	Venüs Pasta Vitrini (Isıtmalı) Venus Pastry Showcase (Heating)	1000	750	1350	165	1.01		0.7		2.500
EMP.BC.130.S	Venüs Pasta Vitrini (Soğutmalı) Venus Pastry Showcase (Cooling)	1300	750	1350	224	1.2	0.5	0.98	1.73	3.050
EMP.BC.130.N	Venüs Pasta Vitrini (Nötr) Venus Pastry Showcase (Neutral)	1300	750	1350	204	1.2				2.575
EMP.BC.130.I	Venüs Pasta Vitrini (Isıtmalı) Venus Pastry Showcase (Heating)	1300	750	1350	210	1.2		0.98		2.850
EMP.BC.160.S	Venüs Pasta Vitrini (Soğutmalı) Venus Pastry Showcase (Cooling)	1600	750	1350	276	1.5	0.5	0.98	1.73	3.450
EMP.BC.160.N	Venüs Pasta Vitrini (Nötr) Venus Pastry Showcase (Neutral)	1600	750	1350	250	1.5				2.750
EMP.BC.160.I	Venüs Pasta Vitrini (Isıtmalı) Venus Pastry Showcase (Heating)	1600	750	1350	255	1.5		0.98		2.950
EMP.BC.200.S	Venüs Pasta Vitrini (Soğutmalı) Venus Pastry Showcase (Cooling)	2000	750	1350	330	1.9	0.75	1.01	2.07	3.900
EMP.BC.200.N	Venüs Pasta Vitrini (Nötr) Venus Pastry Showcase (Neutral)	2000	750	1350	300	1.9				3.050
EMP.BC.200.I	Venüs Pasta Vitrini (Isıtmalı) Venus Pastry Showcase (Heating)	2000	750	1350	305	1.9		1.01		3.350

Türkçe

VENÜS PASTA VİTRİNLERİ

- Çalışma aralığı: +0° C, + 8° C (tropikal 43° C)
- İçten motorlu soğutma uygulaması.
- Reyon altı depolama sistemi.
- Açılabilir ön cam.
- Fanlı soğutma.
- R-134 A soğutucu gaz.
- Led aydınlatma sistemi.
- 40 kg/m3 yoğunluk poliüretan izolasyon.
- Opsiyonel ahşap gövde.

English

VENUS PASTRY SHOWCASE

- Working temperature: 0° C, + 8° C (at ambient temp. 43° C)
- Interior engined refrigeration system
- Under-set storage system.
- Lift up safety front glass.
- Cooling with fan.
- Refrigerant gas:R-134 A
- Led lighting system.
- 40 kg/m3 density polyurathane isolation.
- Optional wooden body colour.

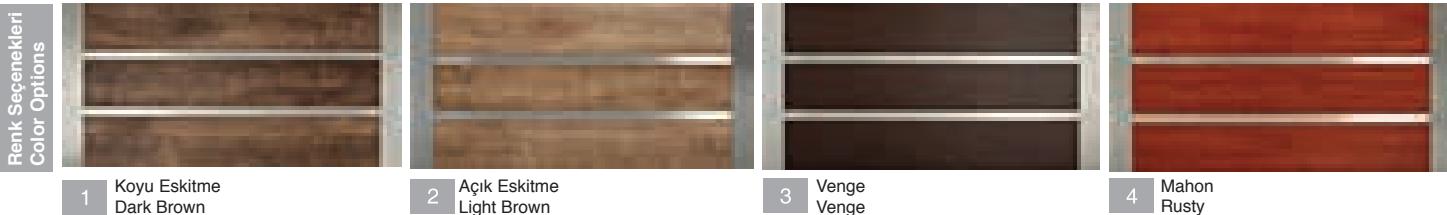

Neptün Pasta Vitrinleri
Neptun Pastry Showcase



Buğulanma yapmayan ön ısı cam.
Condensation blocker double glazing.

Kod Code	Ürün Adı Description	Ebatlar Dimension mm			Ağırlık Weight kg	Net Net m³	Motor Gücü Motor Power kw	Elektrik Gücü Electric Power kw	Soğ. Kap Cooling Cap. kw	Fiyatı Price Euro
		a	b	c						
EMP.DT.100.S	Neptün Pasta Vitrini (Soğutmalı) Neptun Pastry Showcase (Cooling)	1000	750	1350	172	1.01	0.5	0.7	1.15	2.730
EMP.DT.100.N	Neptün Pasta Vitrini (Nötr) Neptun Pastry Showcase (Neutral)	1000	750	1350	158	1.01				2.300
EMP.DT.100.I	Neptün Pasta Vitrini (Isıtmalı) Neptun Pastry Showcase (Heating)	1000	750	1350	165	1.01		0.7		2.500
EMP.DT.130.S	Neptün Pasta Vitrini (Soğutmalı) Neptun Pastry Showcase (Cooling)	1300	750	1350	224	1.2	0.5	0.98	1.73	3.050
EMP.DT.130.N	Neptün Pasta Vitrini (Nötr) Neptun Pastry Showcase (Neutral)	1300	750	1350	204	1.2				2.575
EMP.DT.130.I	Neptün Pasta Vitrini (Isıtmalı) Neptun Pastry Showcase (Heating)	1300	750	1350	210	1.2		0.98		2.850
EMP.DT.160.S	Neptün Pasta Vitrini (Soğutmalı) Neptun Pastry Showcase (Cooling)	1600	750	1350	276	1.5	0.5	0.98	1.73	3.450
EMP.DT.160.N	Neptün Pasta Vitrini (Nötr) Neptun Pastry Showcase (Neutral)	1600	750	1350	250	1.5				2.750
EMP.DT.160.I	Neptün Pasta Vitrini (Isıtmalı) Neptun Pastry Showcase (Heating)	1600	750	1350	255	1.5		0.98		2.950
EMP.DT.200.S	Neptün Pasta Vitrini (Soğutmalı) Neptun Pastry Showcase (Cooling)	2000	750	1350	330	1.9	0.75	1.01	2.07	3.900
EMP.DT.200.N	Neptün Pasta Vitrini (Nötr) Neptun Pastry Showcase (Neutral)	2000	750	1350	300	1.9				3.050
EMP.DT.200.I	Neptün Pasta Vitrini (Isıtmalı) Neptun Pastry Showcase (Heating)	2000	750	1350	305	1.9		1.01		3.350

Türkçe

NEPTÜN PASTA VİTRİNLERİ

- Çalışma aralığı; +0° C, + 8° C (tropikal 43° C)
- İçten motorlu soğutma uygulaması.
- Reyon altı depolama sistemi.
- Fanlı soğutma.
- R-134 A soğutucu gaz.
- Led aydınlatma sistemi.
- 40 kg/m3 yoğunluk poliüretan izolasyon.
- Opsiyonel ahşap gövde.

English

NEPTUN PASTRY SHOWCASE

- Working temperature; 0° C, + 8° C (at ambient temp. 43° C)
- Interior engaged refrigeration system.
- Bottom storage cabinet.
- Cooling with fan.
- Refrigerant gas:R-134 A
- Led lighting system.
- 40 kg/m3 density polyurethane isolation.
- Optional wooden body colour.



Renk Seçenekleri
Color Options



1 Koyu Eskieme
Dark Brown

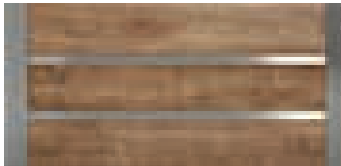

2 Açık Eskieme
Light Brown

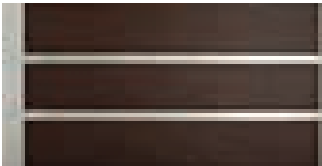

3 Venge
Venge



4 Mahon
Rusty

Servis
Üniteleri
Service Units



İçin Mutfak / Kitchen of Business

empero@empero.com.tr

Servis Üniteleri
Service Units



- * Galata Nötr Servis Ünitesi / Galata Nötr Service Units
- * Galata Nötr Servis Ünitesi Nefeslikli / Galata Nötr Service Units
- * Galata Soğuk Servis Ünitesi Nefeslikli / Galata Cold Service Unit
- * Galata Paslanmaz Soğuk Servis Ünitesi Nefeslikli / Galata S/S Cold Service Units
- * Galata Sıcak Servis Ünitesi (Benmari - Nefeslikli) / Galata Hot Service Units (Bainmarie)
- * Galata Sıcak Servis Ünitesi Nefeslikli / Galata Hot Service Units Chafing Dish
- * Galata Sıcak Servis Ünitesi / Galata Hot Service Units Chafing Dish
- * Galata Çorba Servis Ünitesi / Galata Soup Service Units
- * Galata Ekmek Servis Ünitesi / Galata Bread Service Units
- * Galata U Form Tabaklık / Galata Plate Dispenser Unit
- * Galata Tabak Dispenseri / Galata Plate Dispenser

Galata Nötr Servis Ünitesi

Galata Nötr Service Units



Kod Code	Ebatlar Dimension mm	Fiyatı Price Euro
GLT.NTR.01	1000 x 900 x 900	2.000
GLT.NTR.02	1200 x 900 x 900	2.250
GLT.NTR.03	1400 x 900 x 900	2.490
GLT.NTR.04	1600 x 900 x 900	2.700
GLT.NTR.05	1800 x 900 x 900	2.950
GLT.NTR.06	2000 x 900 x 900	3.200
GLT.NTR.07	2200 x 900 x 900	3.450
GLT.NTR.08	2400 x 900 x 900	3.700

Galata Nötr Servis Ünitesi Nefeslikli

Galata Nötr Service Units



Kod Code	Ebatlar Dimension mm	Fiyatı Price Euro
GLT.NTR-N.01	1000 x 900 x 900 / 1550	2.250
GLT.NTR-N.02	1200 x 900 x 900 / 1550	2.550
GLT.NTR-N.03	1400 x 900 x 900 / 1550	2.790
GLT.NTR-N.04	1600 x 900 x 900 / 1550	3.050
GLT.NTR-N.05	1800 x 900 x 900 / 1550	3.300
GLT.NTR-N.06	2000 x 900 x 900 / 1550	3.600
GLT.NTR-N.07	2200 x 900 x 900 / 1550	3.850
GLT.NTR-N.08	2400 x 900 x 900 / 1550	4.050

Galata Soğuk Servis Ünitesi Nefeslikli
Galata Cold Service Unit



Kod Code	Ebatlar Dimension mm	Fiyatı Price Euro
GLT.SSU-N.01	1000 x 900 x 900 / 1550	3.700
GLT.SSU-N.02	1200 x 900 x 900 / 1550	3.950
GLT.SSU-N.03	1400 x 900 x 900 / 1550	4.160
GLT.SSU-N.04	1600 x 900 x 900 / 1550	4.750
GLT.SSU-N.05	1800 x 900 x 900 / 1550	5.000
GLT.SSU-N.06	2000 x 900 x 900 / 1550	5.200
GLT.SSU-N.07	2200 x 900 x 900 / 1550	5.600
GLT.SSU-N.08	2400 x 900 x 900 / 1550	5.900

Galata Paslanmaz Soğuk Servis Ünitesi Nefeslikli
Galata S/S Cold Service Units



Kod Code	Ebatlar Dimension mm	Fiyatı Price Euro
GLT.P.SSU.01	1000 x 900 x 900 / 1550	3.850
GLT.P.SSU.02	1200 x 900 x 900 / 1550	4.050
GLT.P.SSU.03	1400 x 900 x 900 / 1550	4.300
GLT.P.SSU.04	1600 x 900 x 900 / 1550	4.900
GLT.P.SSU.05	1800 x 900 x 900 / 1550	5.150
GLT.P.SSU.06	2000 x 900 x 900 / 1550	5.400
GLT.P.SSU.07	2200 x 900 x 900 / 1550	5.650
GLT.P.SSU.08	2400 x 900 x 900 / 1550	6.050

Galata Sıcak Servis Ünitesi (Benmari - Nefeslikli)
Galata Hot Service Units (Bainmarie)



Kod Code	Ebatlar Dimension mm	Kapasite Capacity	Fiyatı Price Euro
GLT.SSB.01	1200 x 900 x 900 / 1550	2 x 1/1 GN	3.000
GLT.SSB.02	1600 x 900 x 900 / 1550	3 x 1/1 GN	4.000
GLT.SSB.03	2000 x 900 x 900 / 1550	4 x 1/1 GN	4.900
GLT.SSB.04	2400 x 900 x 900 / 1550	5 x 1/1 GN	5.850

Galata Sıcak Servis Ünitesi Nefeslikli
Galata Hot Service Units Chafing Dish



Kod Code	Ebatlar Dimension mm	Kapasite Capacity	Fiyatı Price Euro
GLT.SSC-N.01	1200 x 900 x 900 / 1550	1 Chafing Dish	3.560
GLT.SSC-N.02	1800 x 900 x 900 / 1550	2 Chafing Dish	5.400
GLT.SSC-N.03	2400 x 900 x 900 / 1550	3 Chafing Dish	7.000

Galata Sıcak Servis Ünitesi Galata Hot Service Units Chafing Dish



Kod Code	Ebatlar Dimension mm	Kapasite Capacity	Fiyatı Price Euro
GLT.SSC.01	1200 x 900 x 900 / 1550	1 Chafing Dish	3.350
GLT.SSC.02	1800 x 900 x 900 / 1550	2 Chafing Dish	5.000
GLT.SSC.03	2400 x 900 x 900 / 1550	3 Chafing Dish	6.500

Galata Çorba Servis Ünitesi Galata Soup Service Units



Kod Code	Ebatlar Dimension mm	Kapasite Capacity	Fiyatı Price Euro
GLT.CSU.01	1400 x 900 x 900	1 Çorbalık / Soup Dispenser	3.700
GLT.CSU.02	2000 x 900 x 900	2 Çorbalık / Soup Dispenser	5.400
GLT.CSU.03	2400 x 900 x 900	3 Çorbalık / Soup Dispenser	5.900

Galata Ekmek Servis Ünitesi
Galata Bread Service Units



Kod Code	Ebatlar Dimension mm	Fiyatı Price Euro
GLT.ESU.01	1000 x 900 x 900 / 1550	2.750
GLT.ESU.02	1200 x 900 x 900 / 1550	2.950
GLT.ESU.03	1400 x 900 x 900 / 1550	3.250
GLT.ESU.04	1600 x 900 x 900 / 1550	3.450
GLT.ESU.05	1800 x 900 x 900 / 1550	3.700
GLT.ESU.06	2000 x 900 x 900 / 1550	3.900
GLT.ESU.07	2200 x 900 x 900 / 1550	4.150
GLT.ESU.08	2400 x 900 x 900 / 1550	4.300

Galata U Form Tabaklık
Galata Plate Dispenser Unit



Kod Code	Ebatlar Dimension mm	Fiyatı Price Euro
GLT.UT.01	1100 x 900 x 900	2.300

Galata Tabak Dispenseri
Galata Plate Dispenser

Kod Code	Ebatlar Dimension mm	Kapasite Capacity	Fiyatı Price Euro
GLT.TD.01	1100 x 900 x 900	2 Tabaklı / Plate Isıtmalı / Heated	3.150
GLT.TD.02	1100 x 900 x 900	2 Tabaklı / Plate Nötr / Neutral	2.500

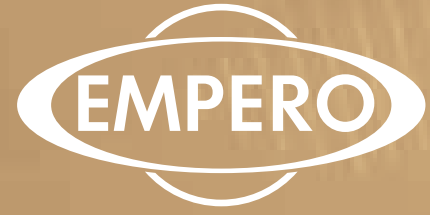

- Kapadokya Nötr Servis Ünitesi / Kapadokya Nötr Service Units ***
- Kapadokya Nötr Servis Ünitesi Nefeslikli / Kapadokya Nötr Service Units ***
- Kapadokya Soğuk Servis Ünitesi Nefeslikli / Kapadokya Cold Service Unit ***
- Kapadokya Paslanmaz Soğuk Servis Ünitesi Nefeslikli / Kapadokya S/S Cold Service Units ***
- Kapadokya Sıcak Servis Ünitesi (Benmari - Nefeslikli) / Kapadokya Hot Service Units (Bainmarie) ***
- Kapadokya Sıcak Servis Ünitesi Nefeslikli / Kapadokya Hot Service Units Chafing Dish ***
- Kapadokya Sıcak Servis Ünitesi / Kapadokya Hot Service Units Chafing Dish ***
- Kapadokya Çorba Servis Ünitesi / Kapadokya Soup Service Units ***
- Kapadokya Ekmek Servis Ünitesi / Kapadokya Bread Service Units ***
- Kapadokya U Form Tabaklık / Kapadokya Plate Dispenser Unit ***
- Kapadokya Tabak Dispenseri / Kapadokya Plate Dispenser ***

Kapadokya Nötr Servis Ünitesi

Kapadokya Nötr Service Units



Kod Code	Ebatlar Dimension mm	Fiyatı Price Euro
KPD.NTR.01	1000 x 900 x 900	2.000
KPD.NTR.02	1200 x 900 x 900	2.250
KPD.NTR.03	1400 x 900 x 900	2.500
KPD.NTR.04	1600 x 900 x 900	2.700
KPD.NTR.05	1800 x 900 x 900	2.950
KPD.NTR.06	2000 x 900 x 900	3.200
KPD.NTR.07	2200 x 900 x 900	3.450
KPD.NTR.08	2400 x 900 x 900	3.700



Kapadokya Nötr Servis Ünitesi Nefeslikli

Kapadokya Nötr Service Units

Kod Code	Ebatlar Dimension mm	Fiyatı Price Euro
KPD.NTR-N.01	1000 x 900 x 900 / 1550	2.255
KPD.NTR-N.02	1200 x 900 x 900 / 1550	2.550
KPD.NTR-N.03	1400 x 900 x 900 / 1550	2.800
KPD.NTR-N.04	1600 x 900 x 900 / 1550	3.050
KPD.NTR-N.05	1800 x 900 x 900 / 1550	3.300
KPD.NTR-N.06	2000 x 900 x 900 / 1550	3.570
KPD.NTR-N.07	2200 x 900 x 900 / 1550	3.850
KPD.NTR-N.08	2400 x 900 x 900 / 1550	4.050

Kapadokya Soğuk Servis Ünitesi Nefeslikli
Kapadokya Cold Service Unit



Kod Code	Ebatlar Dimension mm	Fiyatı Price Euro
KPD.SSU-N.01	1000 x 900 x 900 / 1550	3.750
KPD.SSU-N.02	1200 x 900 x 900 / 1550	3.950
KPD.SSU-N.03	1400 x 900 x 900 / 1550	4.160
KPD.SSU-N.04	1600 x 900 x 900 / 1550	4.750
KPD.SSU-N.05	1800 x 900 x 900 / 1550	5.000
KPD.SSU-N.06	2000 x 900 x 900 / 1550	5.250
KPD.SSU-N.07	2200 x 900 x 900 / 1550	5.550
KPD.SSU-N.08	2400 x 900 x 900 / 1550	5.900

Kapadokya Paslanmaz Soğuk Servis Ünitesi Nefeslikli
Kapadokya S/S Cold Service Units



Kod Code	Ebatlar Dimension mm	Fiyatı Price Euro
KPD.P.SSU.01	1000 x 900 x 900 / 1550	3.850
KPD.P.SSU.02	1200 x 900 x 900 / 1550	4.050
KPD.P.SSU.03	1400 x 900 x 900 / 1550	4.300
KPD.P.SSU.04	1600 x 900 x 900 / 1550	4.900
KPD.P.SSU.05	1800 x 900 x 900 / 1550	5.150
KPD.P.SSU.06	2000 x 900 x 900 / 1550	5.375
KPD.P.SSU.07	2200 x 900 x 900 / 1550	5.630
KPD.P.SSU.08	2400 x 900 x 900 / 1550	6.050



Kapadokya Sıcak Servis Ünitesi (Benmari - Nefeslikli)
Kapadokya Hot Service Units (Bainmarie)



Kod Code	Ebatlar Dimension mm	Kapasite Capacity	Fiyatı Price Euro
KPD.SSB.01	1200 x 900 x 900 / 1550	2 x 1/1 GN	2.970
KPD.SSB.02	1600 x 900 x 900 / 1550	3 x 1/1 GN	3.950
KPD.SSB.03	2000 x 900 x 900 / 1550	4 x 1/1 GN	4.900
KPD.SSB.04	2400 x 900 x 900 / 1550	5 x 1/1 GN	5.830



Kapadokya Sıcak Servis Ünitesi Nefeslikli
Kapadokya Hot Service Units Chafing Dish

Kod Code	Ebatlar Dimension mm	Kapasite Capacity	Fiyatı Price Euro
KPD.SSC-N.01	1200 x 900 x 900 / 1550	1 Chafing Dish	3.650
KPD.SSC-N.02	1800 x 900 x 900 / 1550	2 Chafing Dish	5.350
KPD.SSC-N.03	2400 x 900 x 900 / 1550	3 Chafing Dish	7.050

Kapadokya Sıcak Servis Ünitesi

Kapadokya Hot Service Units Chafing Dish



Kod Code	Ebatlar Dimension mm	Kapasite Capacity	Fiyatı Price Euro
KPD.SSC.01	1200 x 900 x 900 / 1550	1 Chafing Dish	3.350
KPD.SSC.02	1800 x 900 x 900 / 1550	2 Chafing Dish	5.000
KPD.SSC.03	2400 x 900 x 900 / 1550	3 Chafing Dish	6.600

Kapadokya Çorba Servis Ünitesi

Kapadokya Soup Service Units



Kod Code	Ebatlar Dimension mm	Kapasite Capacity	Fiyatı Price Euro
KPD.CSU.01	1400 x 900 x 900	1 Çorbalık / Soup Dispenser	3.700
KPD.CSU.02	2000 x 900 x 900	2 Çorbalık / Soup Dispenser	5.400
KPD.CSU.03	2400 x 900 x 900	3 Çorbalık / Soup Dispenser	5.900



Kapadokya Ekmek Servis Ünitesi

Kapadokya Bread Service Units



Kod Code	Ebatlar Dimension mm	Fiyatı Price Euro
KPD.ESU.01	1000 x 900 x 900 / 1550	2.750
KPD.ESU.02	1200 x 900 x 900 / 1550	2.950
KPD.ESU.03	1400 x 900 x 900 / 1550	3.250
KPD.ESU.04	1600 x 900 x 900 / 1550	3.450
KPD.ESU.05	1800 x 900 x 900 / 1550	3.600
KPD.ESU.06	2000 x 900 x 900 / 1550	3.900
KPD.ESU.07	2200 x 900 x 900 / 1550	4.150
KPD.ESU.08	2400 x 900 x 900 / 1550	4.400

Kapadokya U Form Tabaklık

Kapadokya Plate Dispenser Unit



Kod Code	Ebatlar Dimension mm	Fiyatı Price Euro
KPD.UT.01	1100 x 900 x 900	2.300

Kapadokya Tabak Dispenseri
Kapadokya Plate Dispenser



Kod Code	Ebatlar Dimension mm	Kapasite Capacity	Fiyatı Price Euro
KPD.TD.01	1100 x 900 x 900	2 Tabaklı / Plate Isıtımlı / Heated	3.120
KPD.TD.02	1100 x 900 x 900	2 Tabaklı / Plate Nötr / Neutral	2.550

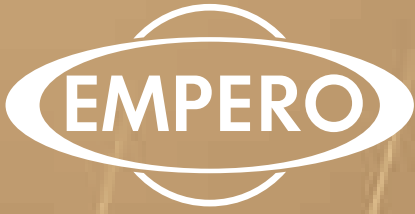

- * Sümela Nötr Servis Ünitesi / Sümela Nötr Service Units
- * Sümela Nötr Servis Ünitesi Nefeslikli / Sümela Nötr Service Units
- * Sümela Soğuk Servis Ünitesi Nefeslikli / Sümela Cold Service Unit
- * Sümela Paslanmaz Soğuk Servis Ünitesi Nefeslikli / Sümela S/S Cold Service Units
- * Sümela Sıcak Servis Ünitesi (Benmari - Nefeslikli) / Sümela Hot Service Units (Bainmarie)
- * Sümela Sıcak Servis Ünitesi Nefeslikli / Sümela Hot Service Units Chafing Dish
- * Sümela Sıcak Servis Ünitesi / Sümela Hot Service Units Chafing Dish
- * Sümela Çorba Servis Ünitesi / Sümela Soup Service Units
- * Sümela Ekmek Servis Ünitesi / Sümela Bread Service Units
- * Sümela U Form Tabaklık / Sümela Plate Dispenser Unit
- * Sümela Tabak Dispenseri / Sümela Plate Dispenser

Sümela Nötr Servis Ünitesi

Sümela Nötr Service Units



Kod Code	Ebatlar Dimension mm	Fiyatı Price Euro
SML.NTR.01	1000 x 900 x 900	2.250
SML.NTR.02	1200 x 900 x 900	2.450
SML.NTR.03	1400 x 900 x 900	2.700
SML.NTR.04	1600 x 900 x 900	3.000
SML.NTR.05	1800 x 900 x 900	3.250
SML.NTR.06	2000 x 900 x 900	3.500
SML.NTR.07	2200 x 900 x 900	3.750
SML.NTR.08	2400 x 900 x 900	4.000

Sümela Nötr Servis Ünitesi Nefeslikli

Sümela Nötr Service Units



Kod Code	Ebatlar Dimension mm	Fiyatı Price Euro
SML.NTR-N.01	1000 x 900 x 900 / 1550	2.500
SML.NTR-N.02	1200 x 900 x 900 / 1550	2.750
SML.NTR-N.03	1400 x 900 x 900 / 1550	3.000
SML.NTR-N.04	1600 x 900 x 900 / 1550	3.300
SML.NTR-N.05	1800 x 900 x 900 / 1550	3.575
SML.NTR-N.06	2000 x 900 x 900 / 1550	3.850
SML.NTR-N.07	2200 x 900 x 900 / 1550	4.150
SML.NTR-N.08	2400 x 900 x 900 / 1550	4.450



Sümela Soğuk Servis Ünitesi Nefeslikli
Sümela Cold Service Unit



Kod Code	Ebatlar Dimension mm	Fiyatı Price Euro
SML.SSU-N.01	1000 x 900 x 900 / 1550	3.900
SML.SSU-N.02	1200 x 900 x 900 / 1550	4.125
SML.SSU-N.03	1400 x 900 x 900 / 1550	4.400
SML.SSU-N.04	1600 x 900 x 900 / 1550	5.000
SML.SSU-N.05	1800 x 900 x 900 / 1550	5.250
SML.SSU-N.06	2000 x 900 x 900 / 1550	5.500
SML.SSU-N.07	2200 x 900 x 900 / 1550	5.750
SML.SSU-N.08	2400 x 900 x 900 / 1550	6.200

Sümela Paslanmaz Soğuk Servis Ünitesi Nefeslikli
Sümela S/S Cold Service Units



Kod Code	Ebatlar Dimension mm	Fiyatı Price Euro
SML.P.SSU.01	1000 x 900 x 900 / 1550	4.050
SML.P.SSU.02	1200 x 900 x 900 / 1550	4.250
SML.P.SSU.03	1400 x 900 x 900 / 1550	4.500
SML.P.SSU.04	1600 x 900 x 900 / 1550	5.150
SML.P.SSU.05	1800 x 900 x 900 / 1550	5.400
SML.P.SSU.06	2000 x 900 x 900 / 1550	5.700
SML.P.SSU.07	2200 x 900 x 900 / 1550	6.000
SML.P.SSU.08	2400 x 900 x 900 / 1550	6.400

Sümela Sıcak Servis Ünitesi (Benmari - Nefeslikli)

Sümela Hot Service Units (Bainmarie)



Kod Code	Ebatlar Dimension mm	Kapasite Capacity	Fiyatı Price Euro
SML.SSB.01	1200 x 900 x 900 / 1550	2 x 1/1 GN	3.200
SML.SSB.02	1600 x 900 x 900 / 1550	3 x 1/1 GN	4.300
SML.SSB.03	2000 x 900 x 900 / 1550	4 x 1/1 GN	5.400
SML.SSB.04	2400 x 900 x 900 / 1550	5 x 1/1 GN	6.400

Sümela Sıcak Servis Ünitesi Nefeslikli

Sümela Hot Service Units Chafing Dish



Kod Code	Ebatlar Dimension mm	Kapasite Capacity	Fiyatı Price Euro
SML.SSC-N.01	1200 x 900 x 900 / 1550	1 Chafing Dish	3.900
SML.SSC-N.02	1800 x 900 x 900 / 1550	2 Chafing Dish	5.650
SML.SSC-N.03	2400 x 900 x 900 / 1550	3 Chafing Dish	7.350

Sümela Sıcak Servis Ünitesi
Sümela Hot Service Units Chafing Dish

Kod Code	Ebatlar Dimension mm	Kapasite Capacity	Fiyatı Price Euro
SML.SSC.01	1200 x 900 x 900 / 1550	1 Chafing Dish	3.575
SML.SSC.02	1800 x 900 x 900 / 1550	2 Chafing Dish	5.260
SML.SSC.03	2400 x 900 x 900 / 1550	3 Chafing Dish	7.000

Sümela Çorba Servis Ünitesi
Sümela Soup Service Units

Kod Code	Ebatlar Dimension mm	Kapasite Capacity	Fiyatı Price Euro
SML.CSU.01	1400 x 900 x 900	1 Çorbalık / Soup Dispenser	3.950
SML.CSU.02	2000 x 900 x 900	2 Çorbalık / Soup Dispenser	5.700
SML.CSU.03	2400 x 900 x 900	3 Çorbalık / Soup Dispenser	6.250

Sümela Ekmek Servis Ünitesi

Sümela Bread Service Units



Kod Code	Ebatlar Dimension mm	Fiyatı Price Euro
SML.ESU.01	1000 x 900 x 900 / 1550	2.950
SML.ESU.02	1200 x 900 x 900 / 1550	3.200
SML.ESU.03	1400 x 900 x 900 / 1550	3.450
SML.ESU.04	1600 x 900 x 900 / 1550	3.700
SML.ESU.05	1800 x 900 x 900 / 1550	4.000
SML.ESU.06	2000 x 900 x 900 / 1550	4.200
SML.ESU.07	2200 x 900 x 900 / 1550	4.500
SML.ESU.08	2400 x 900 x 900 / 1550	4.750

Sümela U Form Tabaklık

Sümela Plate Dispenser Unit



Kod Code	Ebatlar Dimension mm	Fiyatı Price Euro
SML.UT.01	1100 x 900 x 900	2.300

Sümela Tabak Dispenseri
Sümela Plate Dispenser

Kod Code	Ebatlar Dimension mm	Kapasite Capacity	Fiyatı Price Euro
SML.TD.01	1100 x 900 x 900	2 Tabaklı / Plate Isıtmalı / Heated	3.200
SML.TD.02	1100 x 900 x 900	2 Tabaklı / Plate Nötr / Neutral	2.550



Raflar
Shelves



İçin Mutfağı / Kitchen of Business

empero@empero.com.tr



- * Polipropilen Raflar - Delikli / Polipropilen Shelves - Perforated
- * Polipropilen Raflar - Delikli Tablalı / Polipropilen Shelves - Perforated
- * Polipropilen Raflar - Düz / Polipropilen Shelves - Smooth
- * Polipropilen Raflar - Düz Tablalı / Polipropilen Shelves - Smooth
- * Tel Raflar / Wire Shelves
- * Tel Raflar / Wire Shelves
- * Tel Raflar 4 Katlı (1600 mm) / Wire Shelves With 4 Floor (1600 mm)
- * Tel Raflar 4 Katlı (1600 mm) / Wire Shelves With 4 Floor (1600 mm)
- * Tel Raflar 4 Katlı (1800 mm) / Wire Shelves With 4 Floor (1800 mm)
- * Tel Raflar 4 Katlı (1800 mm) / Wire Shelves With 4 Floor (1800 mm)
- * Düz Raflar / Smooth Shelves
- * Düz Raflar / Smooth Shelves
- * Düz Raflar 4 Katlı (1600 mm) / Smooth Shelves With 4 Floor (1600 mm)
- * Düz Raflar 4 Katlı (1600 mm) / Smooth Shelves With 4 Floor (1600 mm)
- * Düz Raflar 4 Katlı (1800 mm) / Smooth Shelves With 4 Floor (1800 mm)
- * Düz Raflar 4 Katlı (1800 mm) / Smooth Shelves With 4 Floor (1800 mm)
- * Delikli Raflar / Perforated Shelves
- * Delikli Raflar / Perforated Shelves
- * Delikli Raflar 4 Katlı (1600 mm) / Perforated Shelves With 4 Floor (1600 mm)
- * Delikli Raflar 4 Katlı (1600 mm) / Perforated Shelves With 4 Floor (1600 mm)
- * Delikli Raflar 4 Katlı (1800 mm) / Perforated Shelves With 4 Floor (1800 mm)
- * Delikli Raflar 4 Katlı (1800 mm) / Perforated Shelves With 4 Floor (1800 mm)
- * Mutfak Bulaşık Arabaları / Soiled Dish Trolleys
- * Mutfak Bulaşık Arabaları / Soiled Dish Trolleys
- * Servis Arabaları / Service Trolleys
- * Taşıma ve Muhafaza Arabaları / Mobile Storage Bins and Transport Carts
- * Taşıma ve Muhafaza Arabaları / Mobile Storage Bins and Transport Carts
- * Tabak Otomatları / Plate Dispensers
- * Yer Filtreleri Alttan Çıkışlı / Floor Filters Bottom Outlet
- * Yer Filtreleri Yandan Çıkışlı / Floor Filters Side Outlet
- * Tel Izgaralar / Wire Grid
- * Davlumbaz Filtreleri / Hood Filters
- * Yağ Ayıtıcı / Grease Separator

Polipropilen Raflar - Delikli Polipropilen Shelves - Perforated

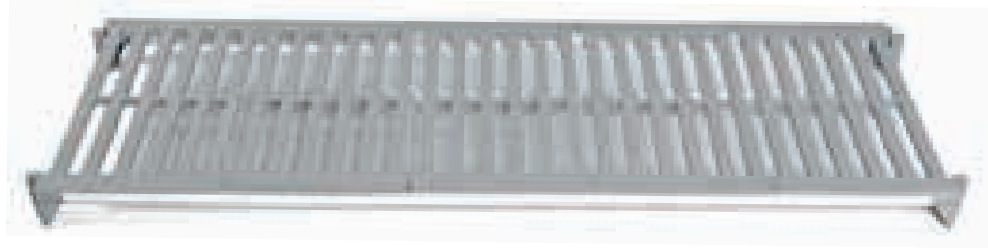

Delikli Raf Plakaları
Perforated Shelf Plates

En:40 cm

Kod Code	Ebatlar Dimension mm	Fiyatı Price Euro
EMP.4097-D	970x400	40
EMP.40127-D	1270x400	50
EMP.40157-D	1570x400	57

En:50 cm

Kod Code	Ebatlar Dimension mm	Fiyatı Price Euro
EMP.5097-D	970x500	41
EMP.50127-D	1270x500	51
EMP.50157-D	1570x500	62

En:60 cm

Kod Code	Ebatlar Dimension mm	Fiyatı Price Euro
EMP.6097-D	970x600	45
EMP.60127-D	1270x600	57
EMP.60157-D	1570x600	68

Alüminyum Raf Ayakları Aluminium Shelf Posts

Kod Code	Ebatlar Dimension mm	Fiyatı Price Euro
EMP.1800-A-40	1800	95
EMP.1800-A-H-40	1800	133
EMP.1800-A-50	1800	95
EMP.1800-A-H-50	1800	133
EMP.1800-A-60	1800	95
EMP.1800-A-H-60	1800	133



EMP.1800-A-H

EMP.1800-A

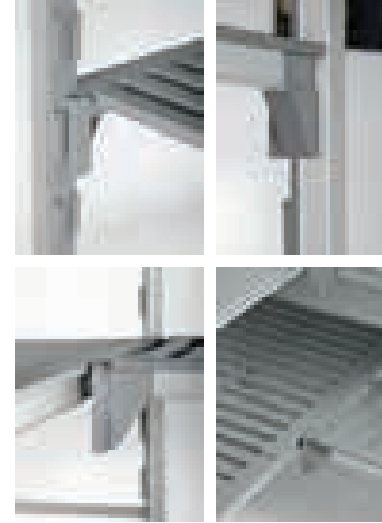

Kod Code	Ürün Adı Description	Fiyatı Price Euro
EMP.1800.KS	Köşe Aparatı Corner Part	23

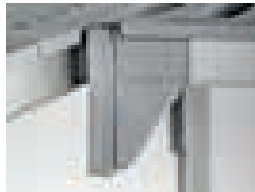

Türkçe

POLİPROPİLEN RAFLAR - DELİKLİ TABLALI

- Hijyenik polipropilen tabla.
- Alüminyum ayak.
- Sökülebilir, yıkanılabilir tabla özelliği.
- Nemli, kuru, soğuk ve sıcak hava koşullarına dayanıklılık.

**Her kat için 140 kg taşıma kapasitesi
140 Kg capacity for each shelf**

English

POLIPROPILEN SHELVES - PERFORATED

- Hygienic polypropylene shelf.
- Aluminum feet.
- Removable, washable shelves.
- Endurance in case of; wet, dry, cold and hot environments.

Polipropilen Raflar - Delikli Tablalı
Polipropilen Shelves - Perforated

En:40 cm

Kod Code	Ebatlar Dimension mm	Fiyatı Price Euro
EMP.4097-18-D	970x400x1800	347
EMP.40127-18-D	1270x400x1800	387
EMP.40157-18-D	1570x400x1800	393
EMP.40190-18-D	1905x400x1800	560
EMP.40220-18-D	2205x400x1800	639
EMP.40250-18-D	2505x400x1800	680
EMP.40280-18-D	2805x400x1800	710
EMP.40310-18-D	3105x400x1800	740
EMP.40344-18-D	3440x400x1800	931
EMP.40374-18-D	3740x400x1800	971
EMP.40404-18-D	4040x400x1800	1.002
EMP.40434-18-D	4340x400x1800	1.063
EMP.40467-18-D	4675x400x1800	1.223
EMP.40497-18-D	4975x400x1800	1.264
EMP.40527-18-D	5275x400x1800	1.294
EMP.40557-18-D	5575x400x1800	1.324
EMP.40587-18-D	5875x400x1800	1.355
EMP.40617-18-D	6175x400x1800	1.385

En:50 cm

Kod Code	Ebatlar Dimension mm	Fiyatı Price Euro
EMP.5097-18-D	970x500x1800	352
EMP.50127-18-D	1270x500x1800	393
EMP.50157-18-D	1570x500x1800	438
EMP.50190-18-D	1905x500x1800	608
EMP.50220-18-D	2205x500x1800	649
EMP.50250-18-D	2505x500x1800	690
EMP.50280-18-D	2805x500x1800	735
EMP.50310-18-D	3105x500x1800	781
EMP.50344-18-D	3440x500x1800	946
EMP.50374-18-D	3740x500x1800	987
EMP.50404-18-D	4040x500x1800	1032
EMP.50434-18-D	4340x500x1800	1121
EMP.50467-18-D	4675x500x1800	1243
EMP.50497-18-D	4975x500x1800	1284
EMP.50527-18-D	5275x500x1800	1330
EMP.50557-18-D	5575x500x1800	1375
EMP.50587-18-D	5875x500x1800	1420
EMP.50617-18-D	6175x500x1800	1466

En:60 cm

Kod Code	Ebatlar Dimension mm	Fiyatı Price Euro
EMP.6097-18-D	970x600x1800	372
EMP.60127-18-D	1270x600x1800	418
EMP.60157-18-D	1570x600x1800	463
EMP.60190-18-D	1905x600x1800	649
EMP.60220-18-D	2205x600x1800	694
EMP.60250-18-D	2505x600x1800	740
EMP.60280-18-D	2805x600x1800	785
EMP.60310-18-D	3105x600x1800	832
EMP.60344-18-D	3440x600x1800	1.018
EMP.60374-18-D	3740x600x1800	1.063
EMP.60404-18-D	4040x600x1800	1.108
EMP.60434-18-D	4340x600x1800	1.199
EMP.60467-18-D	4675x600x1800	1.340
EMP.60497-18-D	4975x600x1800	1.385
EMP.60527-18-D	5275x600x1800	1.431
EMP.60557-18-D	5575x600x1800	1.476
EMP.60587-18-D	5875x600x1800	1.521
EMP.60617-18-D	6175x600x1800	1.568

Türkçe
POLİPROPİLEN RAFLAR - DELİKLİ TABLALI

- Hijyenik polipropilen tabla.
- Alüminyum ayak.
- Sökülebilir, yıkanılabilir tabla özelliği.
- Nemli, kuru, soğuk ve sıcak hava koşullarına dayanıklılık.

Her kat için 140 kg taşıma kapasitesi
140 Kg capacity for each shelf

English
POLIPROPILEN SHELVES - PERFORATED

- Hygienic polypropylene shelves.
- Aluminum feet.
- Removable, washable shelves.
- Endurance in case of; wet, dry, cold and hot environments.

Polipropilen Raflar - Düz

Polipropilen Shelves - Smooth

Düz Raf Plakaları

Smooth Shelf Plates

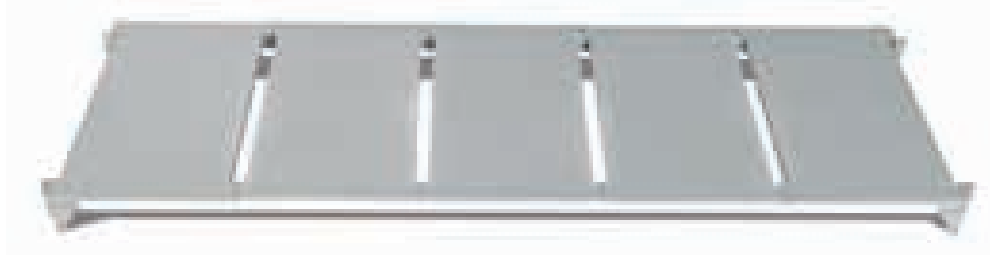

En:40 cm

Kod Code	Ebatlar Dimension mm	Fiyatı Price Euro
EMP.4097	970x400	43
EMP.40127	1270x400	53
EMP.40157	1570x400	65

En:50 cm

Kod Code	Ebatlar Dimension mm	Fiyatı Price Euro
EMP.5097	970x500	44
EMP.50127	1270x500	56
EMP.50157	1570x500	67

En:60 cm

Kod Code	Ebatlar Dimension mm	Fiyatı Price Euro
EMP.6097	970x600	48
EMP.60127	1270x600	61
EMP.60157	1570x600	74

Alüminyum Raf Ayakları

Aluminium Shelf Posts

Kod Code	Ebatlar Dimension mm	Fiyatı Price Euro
EMP.1800-A-40	1800	95
EMP.1800-A-H-40	1800	133
EMP.1800-A-50	1800	95
EMP.1800-A-H-50	1800	133
EMP.1800-A-60	1800	95
EMP.1800-A-H-60	1800	133



EMP.1800-A-H

EMP.1800-A



Kod Code	Ürün Adı Description	Fiyatı Price Euro
EMP.1800.KS	Köşe Aparatı Corner Part	23



Türkçe

POLİPROPİLEN RAFLAR - DÜZ TABLALI

- Hijyenik polipropilen tabla.
- Alüminyum ayak.
- Sökülebilir, yıkanılabilir tabla özelliği.
- Nemli, kuru, soğuk ve sıcak hava koşullarına dayanıklılık.

Her kat için 140 kg taşıma kapasitesi
140 Kg capacity for each shelf

English

POLIPROPILEN SHELVES - SMOOTH

- Hygienic polypropylene shelf.
- Aluminum feet.
- Removable, washable shelves.
- Endurance in case of; wet, dry, cold and hot environments.

Polipropilen Raflar - Düz Tablalı
Polipropilen Shelves - Smooth

En:40 cm

Kod Code	Ebatlar Dimension mm	Fiyatı Price Euro
EMP.4097-18	970x400x1800	362
EMP.40127-18	1270x400x1800	403
EMP.40157-18	1570x400x1800	448
EMP.40190-18	1905x400x1800	629
EMP.40220-18	2205x400x1800	669
EMP.40250-18	2505x400x1800	710
EMP.40280-18	2805x400x1800	756
EMP.40310-18	3105x400x1800	801
EMP.40344-18	3440x400x1800	977
EMP.40374-18	3740x400x1800	1.018
EMP.40404-18	4040x400x1800	1.063
EMP.40434-18	4340x400x1800	1.154
EMP.40467-18	4675x400x1800	1.284
EMP.40497-18	4975x400x1800	1.324
EMP.40527-18	5275x400x1800	1.370
EMP.40557-18	5575x400x1800	1.416
EMP.40587-18	5875x400x1800	1.461
EMP.40617-18	6175x400x1800	1.507

En:50 cm

Kod Code	Ebatlar Dimension mm	Fiyatı Price Euro
EMP.5097-18	970x500x1800	367
EMP.50127-18	1270x500x1800	413
EMP.50157-18	1570x500x1800	458
EMP.50190-18	1905x500x1800	639
EMP.50220-18	2205x500x1800	684
EMP.50250-18	2505x500x1800	730
EMP.50280-18	2805x500x1800	776
EMP.50310-18	3105x500x1800	821
EMP.50344-18	3440x500x1800	1.002
EMP.50374-18	3740x500x1800	1.035
EMP.50404-18	4040x500x1800	1.093
EMP.50434-18	4340x500x1800	1.184
EMP.50467-18	4675x500x1800	1.319
EMP.50497-18	4975x500x1800	1.365
EMP.50527-18	5275x500x1800	1.410
EMP.50557-18	5575x500x1800	1.456
EMP.50587-18	5875x500x1800	1.502
EMP.50617-18	6175x500x1800	1.547

En:60 cm

Kod Code	Ebatlar Dimension mm	Fiyatı Price Euro
EMP.6097-18	970x600x1800	382
EMP.60127-18	1270x600x1800	432
EMP.60157-18	1570x600x1800	483
EMP.60190-18	1905x600x1800	669
EMP.60220-18	2205x600x1800	719
EMP.60250-18	2505x600x1800	770
EMP.60280-18	2805x600x1800	815
EMP.60310-18	3105x600x1800	871
EMP.60344-18	3440x600x1800	1.057
EMP.60374-18	3740x600x1800	1.108
EMP.60404-18	4040x600x1800	1.158
EMP.60434-18	4340x600x1800	1.260
EMP.60467-18	4675x600x1800	1.395
EMP.60497-18	4975x600x1800	1.445
EMP.60527-18	5275x600x1800	1.496
EMP.60557-18	5575x600x1800	1.547
EMP.60587-18	5875x600x1800	1.597
EMP.60617-18	6175x600x1800	1.648

Türkçe
POLİPROPİLEN RAFLAR - DÜZ TABLALI

- Hijyenik polipropilen tabla.
- Alüminyum ayak.
- Sökülebilir, yıkanılabilir tabla özelliği.
- Nemli, kuru, soğuk ve sıcak hava koşullarına dayanıklılık.

English
POLIPROPILEN SHELVES - SMOOTH

- Hygienic polypropylene shelves.
- Aluminum feet.
- Removable, washable shelves.
- Endurance in case of; wet, dry, cold and hot environments.

Her kat için 140 kg taşıma kapasitesi
140 Kg capacity for each shelf

Tel Raflar
Wire Shelves

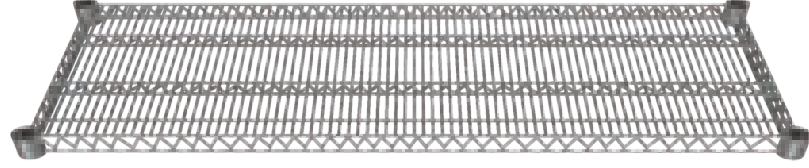

INOX 304

Kod Code	Ebatlar Dimension mm	Fiyati Price Euro
EMP.T.3.3676	360x760	35
EMP.T.3.3691	360x910	40
EMP.T.3.36107	360x1070	46
EMP.T.3.36122	360x1220	51
EMP.T.3.36137	360x1370	56
EMP.T.3.36152	360x1520	66
EMP.T.3.36183	360x1830	78

INOX 201

Kod Code	Ebatlar Dimension mm	Fiyati Price Euro
EMP.T.2.3676	360x760	26
EMP.T.2.3691	360x910	29
EMP.T.2.36107	360x1070	33
EMP.T.2.36122	360x1220	36
EMP.T.2.36137	360x1370	40
EMP.T.2.36152	360x1520	47
EMP.T.2.36183	360x1830	54

Kod Code	Ebatlar Dimension mm	Fiyati Price Euro
EMP.T.3.4676	460x760	40
EMP.T.3.4691	460x910	46
EMP.T.3.46107	460x1070	52
EMP.T.3.46122	460x1220	57
EMP.T.3.46137	460x1370	68
EMP.T.3.46152	460x1520	75
EMP.T.3.46183	460x1830	87

Kod Code	Ebatlar Dimension mm	Fiyati Price Euro
EMP.T.2.4676	460x760	32
EMP.T.2.4691	460x910	36
EMP.T.2.46107	460x1070	38
EMP.T.2.46122	460x1220	41
EMP.T.2.46137	460x1370	48
EMP.T.2.46152	460x1520	52
EMP.T.2.46183	460x1830	61

INOX 304

Kod Code	Ebatlar Dimension mm	Fiyati Price Euro
EMP.1600-3	1600	29
EMP.1800-3	1800	32
EMP.1600-3-H	1600	45
EMP.1800-3-H	1800	49

INOX 201

Kod Code	Ebatlar Dimension mm	Fiyati Price Euro
EMP.1600-2	1600	23
EMP.1800-2	1800	24
EMP.1600-2-H	1600	39
EMP.1800-2-H	1800	41

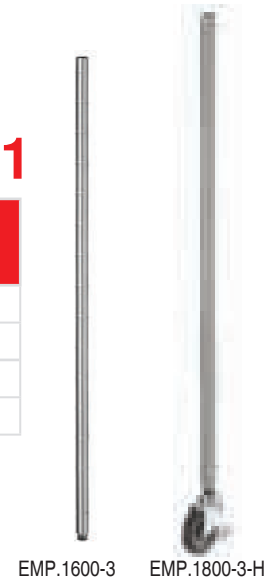

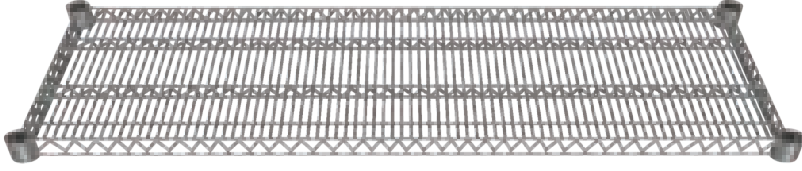

INOX 304

INOX 201

Kod Code	Ebatlar Dimension mm	Fiyatı Price Euro
EMP.T.3.5376	530x760	42
EMP.T.3.5391	530x910	49
EMP.T.3.53107	530x1070	57
EMP.T.3.53122	530x1220	72
EMP.T.3.53137	530x1370	79
EMP.T.3.53152	530x1520	85
EMP.T.3.53183	530x1830	100

Kod Code	Ebatlar Dimension mm	Fiyatı Price Euro
EMP.T.2.5376	530x760	33
EMP.T.2.5391	530x910	37
EMP.T.2.53107	530x1070	40
EMP.T.2.53122	530x1220	51
EMP.T.2.53137	530x1370	57
EMP.T.2.53152	530x1520	61
EMP.T.2.53183	530x1830	72

Kod Code	Ebatlar Dimension mm	Fiyatı Price Euro
EMP.T.3.6176	610x760	47
EMP.T.3.6191	610x910	57
EMP.T.3.61107	610x1070	68
EMP.T.3.61122	610x1220	76
EMP.T.3.61137	610x1370	85
EMP.T.3.61152	610x1520	94
EMP.T.3.61183	610x1830	105

Kod Code	Ebatlar Dimension mm	Fiyatı Price Euro
EMP.T.2.6176	610x760	36
EMP.T.2.6191	610x910	43
EMP.T.2.61107	610x1070	49
EMP.T.2.61122	610x1220	57
EMP.T.2.61137	610x1370	62
EMP.T.2.61152	610x1520	68
EMP.T.2.61183	610x1830	76

Tel Raflar 4 Katlı (1600 mm)
Wire Shelves With 4 Floor (1600 mm)



INOX 304

INOX 201

Kod Code	Ebatlar Dimension mm	Fiyatı Price Euro
EMP.T.3.3676-16-4	360x760x1600	256
EMP.T.3.3691-16-4	360x910x1600	276
EMP.T.3.36107-16-4	360x1070x1600	300
EMP.T.3.36122-16-4	360x1220x1600	320
EMP.T.3.36137-16-4	360x1370x1600	340
EMP.T.3.36152-16-4	360x1520x1600	380
EMP.T.3.36183-16-4	360x1830x1600	428

Kod Code	Ebatlar Dimension mm	Fiyatı Price Euro
EMP.T.2.3676-16-4	360x760x1600	196
EMP.T.2.3691-16-4	360x910x1600	208
EMP.T.2.36107-16-4	360x1070x1600	224
EMP.T.2.36122-16-4	360x1220x1600	236
EMP.T.2.36137-16-4	360x1370x1600	252
EMP.T.2.36152-16-4	360x1520x1600	280
EMP.T.2.36183-16-4	360x1830x1600	308

Kod Code	Ebatlar Dimension mm	Fiyatı Price Euro
EMP.T.3.4676-16-4	460x760x1600	276
EMP.T.3.4691-16-4	460x910x1600	300
EMP.T.3.46107-16-4	460x1070x1600	324
EMP.T.3.46122-16-4	460x1220x1600	344
EMP.T.3.46137-16-4	460x1370x1600	388
EMP.T.3.46152-16-4	460x1520x1600	416
EMP.T.3.46183-16-4	460x1830x1600	464

Kod Code	Ebatlar Dimension mm	Fiyatı Price Euro
EMP.T.2.4676-16-4	460x760x1600	220
EMP.T.2.4691-16-4	460x910x1600	236
EMP.T.2.46107-16-4	460x1070x1600	244
EMP.T.2.46122-16-4	460x1220x1600	256
EMP.T.2.46137-16-4	460x1370x1600	284
EMP.T.2.46152-16-4	460x1520x1600	300
EMP.T.2.46183-16-4	460x1830x1600	336

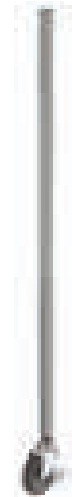

Tel Raflar 4 Katlı (1600 mm)
Wire Shelves With 4 Floor (1600 mm)

INOX 304

Kod Code	Ebatlar Dimension mm	Fiyatı Price Euro
EMP.T.3.5376-16-4	530x760x1600	284
EMP.T.3.5391-16-4	530x910x1600	312
EMP.T.3.53107-16-4	530x1070x1600	344
EMP.T.3.53122-16-4	530x1220x1600	404
EMP.T.3.53137-16-4	530x1370x1600	432
EMP.T.3.53152-16-4	530x1520x1600	456
EMP.T.3.53183-16-4	530x1830x1600	516

INOX 201

Kod Code	Ebatlar Dimension mm	Fiyatı Price Euro
EMP.T.2.5376-16-4	530x760x1600	224
EMP.T.2.5391-16-4	530x910x1600	240
EMP.T.2.53107-16-4	530x1070x1600	252
EMP.T.2.53122-16-4	530x1220x1600	296
EMP.T.2.53137-16-4	530x1370x1600	320
EMP.T.2.53152-16-4	530x1520x1600	336
EMP.T.2.53183-16-4	530x1830x1600	380

Kod Code	Ebatlar Dimension mm	Fiyatı Price Euro
EMP.T.3.6176-16-4	610x760x1600	304
EMP.T.3.6191-16-4	610x910x1600	344
EMP.T.3.61107-16-4	610x1070x1600	388
EMP.T.3.61122-16-4	610x1220x1600	420
EMP.T.3.61137-16-4	610x1370x1600	456
EMP.T.3.61152-16-4	610x1520x1600	492
EMP.T.3.61183-16-4	610x1830x1600	536

Kod Code	Ebatlar Dimension mm	Fiyatı Price Euro
EMP.T.2.6176-16-4	610x760x1600	236
EMP.T.2.6191-16-4	610x910x1600	264
EMP.T.2.61107-16-4	610x1070x1600	288
EMP.T.2.61122-16-4	610x1220x1600	320
EMP.T.2.61137-16-4	610x1370x1600	340
EMP.T.2.61152-16-4	610x1520x1600	364
EMP.T.2.61183-16-4	610x1830x1600	396

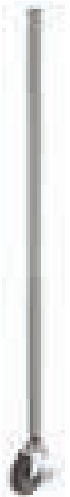

Tel Raflar 4 Katlı (1800 mm)
Wire Shelves With 4 Floor (1800 mm)



INOX 304

Kod Code	Ebatlar Dimension mm	Fiyatı Price Euro
EMP.T.3.3676-18-4	360x760x1800	268
EMP.T.3.3691-18-4	360x910x1800	288
EMP.T.3.36107-18-4	360x1070x1800	312
EMP.T.3.36122-18-4	360x1220x1800	332
EMP.T.3.36137-18-4	360x1370x1800	352
EMP.T.3.36152-18-4	360x1520x1800	392
EMP.T.3.36183-18-4	360x1830x1800	440

INOX 201

Kod Code	Ebatlar Dimension mm	Fiyatı Price Euro
EMP.T.2.3676-18-4	360x760x1800	200
EMP.T.2.3691-18-4	360x910x1800	212
EMP.T.2.36107-18-4	360x1070x1800	228
EMP.T.2.36122-18-4	360x1220x1800	240
EMP.T.2.36137-18-4	360x1370x1800	256
EMP.T.2.36152-18-4	360x1520x1800	284
EMP.T.2.36183-18-4	360x1830x1800	312

Kod Code	Ebatlar Dimension mm	Fiyatı Price Euro
EMP.T.3.4676-18-4	460x760x1800	288
EMP.T.3.4691-18-4	460x910x1800	312
EMP.T.3.46107-18-4	460x1070x1800	336
EMP.T.3.46122-18-4	460x1220x1800	356
EMP.T.3.46137-18-4	460x1370x1800	400
EMP.T.3.46152-18-4	460x1520x1800	428
EMP.T.3.46183-18-4	460x1830x1800	476

Kod Code	Ebatlar Dimension mm	Fiyatı Price Euro
EMP.T.2.4676-18-4	460x760x1800	224
EMP.T.2.4691-18-4	460x910x1800	240
EMP.T.2.46107-18-4	460x1070x1800	248
EMP.T.2.46122-18-4	460x1220x1800	260
EMP.T.2.46137-18-4	460x1370x1800	288
EMP.T.2.46152-18-4	460x1520x1800	304
EMP.T.2.46183-18-4	460x1830x1800	340

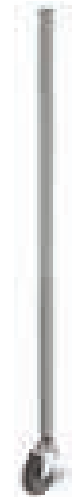

Tel Raflar 4 Katlı (1800 mm)
Wire Shelves With 4 Floor (1800 mm)

INOX 304

Kod Code	Ebatlar Dimension mm	Fiyatı Price Euro
EMP.T.3.5376-18-4	530x760x1800	296
EMP.T.3.5391-18-4	530x910x1800	324
EMP.T.3.53107-18-4	530x1070x1800	356
EMP.T.3.53122-18-4	530x1220x1800	416
EMP.T.3.53137-18-4	530x1370x1800	444
EMP.T.3.53152-18-4	530x1520x1800	468
EMP.T.3.53183-18-4	530x1830x1800	528

INOX 201

Kod Code	Ebatlar Dimension mm	Fiyatı Price Euro
EMP.T.2.5376-18-4	530x760x1800	228
EMP.T.2.5391-18-4	530x910x1800	244
EMP.T.2.53107-18-4	530x1070x1800	256
EMP.T.2.53122-18-4	530x1220x1800	300
EMP.T.2.53137-18-4	530x1370x1800	324
EMP.T.2.53152-18-4	530x1520x1800	340
EMP.T.2.53183-18-4	530x1830x1800	384

Kod Code	Ebatlar Dimension mm	Fiyatı Price Euro
EMP.T.3.6176-18-4	610x760x1800	316
EMP.T.3.6191-18-4	610x910x1800	356
EMP.T.3.61107-18-4	610x1070x1800	400
EMP.T.3.61122-18-4	610x1220x1800	432
EMP.T.3.61137-18-4	610x1370x1800	468
EMP.T.3.61152-18-4	610x1520x1800	504
EMP.T.3.61183-18-4	610x1830x1800	548

Kod Code	Ebatlar Dimension mm	Fiyatı Price Euro
EMP.T.2.6176-18-4	610x760x1800	240
EMP.T.2.6191-18-4	610x910x1800	268
EMP.T.2.61107-18-4	610x1070x1800	292
EMP.T.2.61122-18-4	610x1220x1800	324
EMP.T.2.61137-18-4	610x1370x1800	344
EMP.T.2.61152-18-4	610x1520x1800	368
EMP.T.2.61183-18-4	610x1830x1800	400

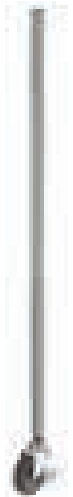

Düz Raflar
Smooth Shelves

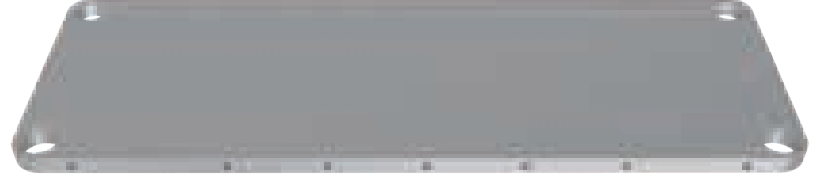

INOX 304

Kod Code	Ebatlar Dimension mm	Fiyatı Price Euro
EMP.D.3.3676	360x760	55
EMP.D.3.3691	360x910	62
EMP.D.3.36107	360x1070	70
EMP.D.3.36122	360x1220	78
EMP.D.3.36137	360x1370	85
EMP.D.3.36152	360x1520	93
EMP.D.3.36183	360x1830	108

INOX 201

Kod Code	Ebatlar Dimension mm	Fiyatı Price Euro
EMP.D.2.3676	360x760	46
EMP.D.2.3691	360x910	52
EMP.D.2.36107	360x1070	59
EMP.D.2.36122	360x1220	64
EMP.D.2.36137	360x1370	70
EMP.D.2.36152	360x1520	76
EMP.D.2.36183	360x1830	88

Kod Code	Ebatlar Dimension mm	Fiyatı Price Euro
EMP.D.3.4676	460x760	61
EMP.D.3.4691	460x910	69
EMP.D.3.46107	460x1070	79
EMP.D.3.46122	460x1220	88
EMP.D.3.46137	460x1370	96
EMP.D.3.46152	460x1520	105
EMP.D.3.46183	460x1830	123

Kod Code	Ebatlar Dimension mm	Fiyatı Price Euro
EMP.D.2.4676	460x760	51
EMP.D.2.4691	460x910	58
EMP.D.2.46107	460x1070	65
EMP.D.2.46122	460x1220	72
EMP.D.2.46137	460x1370	79
EMP.D.2.46152	460x1520	86
EMP.D.2.46183	460x1830	100

INOX 304

Kod Code	Ebatlar Dimension mm	Fiyatı Price Euro
EMP.1600-3	1600	29
EMP.1800-3	1800	32
EMP.1600-3-H	1600	45
EMP.1800-3-H	1800	49

INOX 201

Kod Code	Ebatlar Dimension mm	Fiyatı Price Euro
EMP.1600-2	1600	23
EMP.1800-2	1800	24
EMP.1600-2-H	1600	39
EMP.1800-2-H	1800	41

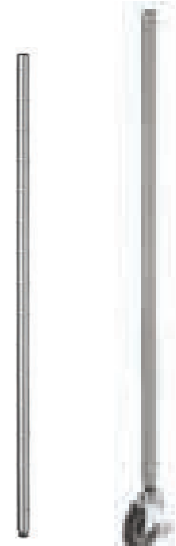

EMP.1600-3 EMP.1800-3-H

Düz Raflar
Smooth Shelves

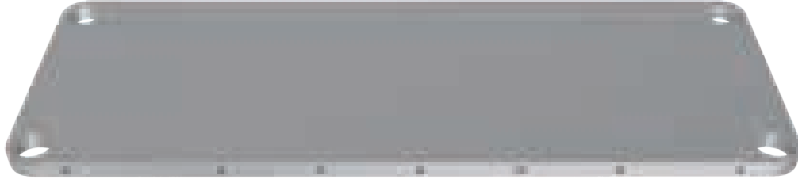

INOX 304

Kod Code	Ebatlar Dimension mm	Fiyatı Price Euro
EMP.D.3.5376	530x760	66
EMP.D.3.5391	530x910	75
EMP.D.3.53107	530x1070	85
EMP.D.3.53122	530x1220	94
EMP.D.3.53137	530x1370	104
EMP.D.3.53152	530x1520	113
EMP.D.3.53183	530x1830	133

INOX 201

Kod Code	Ebatlar Dimension mm	Fiyatı Price Euro
EMP.D.2.5376	530x760	55
EMP.D.2.5391	530x910	62
EMP.D.2.53107	530x1070	70
EMP.D.2.53122	530x1220	78
EMP.D.2.53137	530x1370	85
EMP.D.2.53152	530x1520	93
EMP.D.2.53183	530x1830	108

Kod Code	Ebatlar Dimension mm	Fiyatı Price Euro
EMP.D.3.6176	610x760	70
EMP.D.3.6191	610x910	81
EMP.D.3.61107	610x1070	92
EMP.D.3.61122	610x1220	102
EMP.D.3.61137	610x1370	112
EMP.D.3.61152	610x1520	123
EMP.D.3.61183	610x1830	145

Kod Code	Ebatlar Dimension mm	Fiyatı Price Euro
EMP.D.2.6176	610x760	59
EMP.D.2.6191	610x910	67
EMP.D.2.61107	610x1070	75
EMP.D.2.61122	610x1220	83
EMP.D.2.61137	610x1370	92
EMP.D.2.61152	610x1520	100
EMP.D.2.61183	610x1830	117

Düz Raflar 4 Katlı (1600 mm)
Smooth Shelves With 4 Floor (1600 mm)



INOX 304

INOX 201

Kod Code	Ebatlar Dimension mm	Fiyatı Price Euro
EMP.D.3.3676-16-4	360x760x1600	334
EMP.D.3.3691-16-4	360x910x1600	364
EMP.D.3.36107-16-4	360x1070x1600	397
EMP.D.3.36122-16-4	360x1220x1600	427
EMP.D.3.36137-16-4	360x1370x1600	456
EMP.D.3.36152-16-4	360x1520x1600	486
EMP.D.3.36183-16-4	360x1830x1600	549

Kod Code	Ebatlar Dimension mm	Fiyatı Price Euro
EMP.D.2.3676-16-4	360x760x1600	277
EMP.D.2.3691-16-4	360x910x1600	300
EMP.D.2.36107-16-4	360x1070x1600	327
EMP.D.2.36122-16-4	360x1220x1600	350
EMP.D.2.36137-16-4	360x1370x1600	373
EMP.D.2.36152-16-4	360x1520x1600	396
EMP.D.2.36183-16-4	360x1830x1600	446

Kod Code	Ebatlar Dimension mm	Fiyatı Price Euro
EMP.D.3.4676-16-4	460x760x1600	361
EMP.D.3.4691-16-4	460x910x1600	394
EMP.D.3.46107-16-4	460x1070x1600	430
EMP.D.3.46122-16-4	460x1220x1600	466
EMP.D.3.46137-16-4	460x1370x1600	499
EMP.D.3.46152-16-4	460x1520x1600	536
EMP.D.3.46183-16-4	460x1830x1600	609

Kod Code	Ebatlar Dimension mm	Fiyatı Price Euro
EMP.D.2.4676-16-4	460x760x1600	297
EMP.D.2.4691-16-4	460x910x1600	323
EMP.D.2.46107-16-4	460x1070x1600	353
EMP.D.2.46122-16-4	460x1220x1600	380
EMP.D.2.46137-16-4	460x1370x1600	409
EMP.D.2.46152-16-4	460x1520x1600	436
EMP.D.2.46183-16-4	460x1830x1600	492

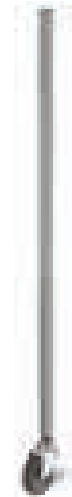

Düz Raflar 4 Katlı (1600 mm)
Smooth Shelves With 4 Floor (1600 mm)

INOX 304

Kod Code	Ebatlar Dimension mm	Fiyatı Price Euro
EMP.D.3.5376-16-4	530x760x1600	380
EMP.D.3.5391-16-4	530x910x1600	417
EMP.D.3.53107-16-4	530x1070x1600	456
EMP.D.3.53122-16-4	530x1220x1600	493
EMP.D.3.53137-16-4	530x1370x1600	533
EMP.D.3.53152-16-4	530x1520x1600	569
EMP.D.3.53183-16-4	530x1830x1600	648

INOX 201

Kod Code	Ebatlar Dimension mm	Fiyatı Price Euro
EMP.D.2.5376-16-4	530x760x1600	310
EMP.D.2.5391-16-4	530x910x1600	340
EMP.D.2.53107-16-4	530x1070x1600	373
EMP.D.2.53122-16-4	530x1220x1600	403
EMP.D.2.53137-16-4	530x1370x1600	432
EMP.D.2.53152-16-4	530x1520x1600	462
EMP.D.2.53183-16-4	530x1830x1600	525

Kod Code	Ebatlar Dimension mm	Fiyatı Price Euro
EMP.D.3.6176-16-4	610x760x1600	397
EMP.D.3.6191-16-4	610x910x1600	440
EMP.D.3.61107-16-4	610x1070x1600	483
EMP.D.3.61122-16-4	610x1220x1600	526
EMP.D.3.61137-16-4	610x1370x1600	566
EMP.D.3.61152-16-4	610x1520x1600	609
EMP.D.3.61183-16-4	610x1830x1600	694

Kod Code	Ebatlar Dimension mm	Fiyatı Price Euro
EMP.D.2.6176-16-4	610x760x1600	327
EMP.D.2.6191-16-4	610x910x1600	360
EMP.D.2.61107-16-4	610x1070x1600	393
EMP.D.2.61122-16-4	610x1220x1600	426
EMP.D.2.61137-16-4	610x1370x1600	459
EMP.D.2.61152-16-4	610x1520x1600	492
EMP.D.2.61183-16-4	610x1830x1600	561

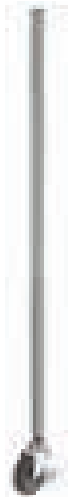

Düz Raflar 4 Katlı (1800 mm)
Smooth Shelves With 4 Floor (1800 mm)



INOX 304

Kod Code	Ebatlar Dimension mm	Fiyatı Price Euro
EMP.D.3.3676-18-4	360x760x1800	346
EMP.D.3.3691-18-4	360x910x1800	376
EMP.D.3.36107-18-4	360x1070x1800	409
EMP.D.3.36122-18-4	360x1220x1800	439
EMP.D.3.36137-18-4	360x1370x1800	468
EMP.D.3.36152-18-4	360x1520x1800	498
EMP.D.3.36183-18-4	360x1830x1800	561

INOX 201

Kod Code	Ebatlar Dimension mm	Fiyatı Price Euro
EMP.D.2.3676-18-4	360x760x1800	280
EMP.D.2.3691-18-4	360x910x1800	304
EMP.D.2.36107-18-4	360x1070x1800	332
EMP.D.2.36122-18-4	360x1220x1800	352
EMP.D.2.36137-18-4	360x1370x1800	376
EMP.D.2.36152-18-4	360x1520x1800	400
EMP.D.2.36183-18-4	360x1830x1800	448

Kod Code	Ebatlar Dimension mm	Fiyatı Price Euro
EMP.D.3.4676-18-4	460x760x1800	373
EMP.D.3.4691-18-4	460x910x1800	406
EMP.D.3.46107-18-4	460x1070x1800	442
EMP.D.3.46122-18-4	460x1220x1800	480
EMP.D.3.46137-18-4	460x1370x1800	511
EMP.D.3.46152-18-4	460x1520x1800	548
EMP.D.3.46183-18-4	460x1830x1800	621

Kod Code	Ebatlar Dimension mm	Fiyatı Price Euro
EMP.D.2.4676-18-4	460x760x1800	300
EMP.D.2.4691-18-4	460x910x1800	328
EMP.D.2.46107-18-4	460x1070x1800	356
EMP.D.2.46122-18-4	460x1220x1800	384
EMP.D.2.46137-18-4	460x1370x1800	412
EMP.D.2.46152-18-4	460x1520x1800	440
EMP.D.2.46183-18-4	460x1830x1800	496

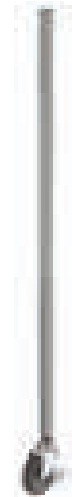

Düz Raflar 4 Katlı (1800 mm)
Smooth Shelves With 4 Floor (1800 mm)

INOX 304

Kod Code	Ebatlar Dimension mm	Fiyatı Price Euro
EMP.D.3.5376-18-4	530x760x1800	392
EMP.D.3.5391-18-4	530x910x1800	429
EMP.D.3.53107-18-4	530x1070x1800	468
EMP.D.3.53122-18-4	530x1220x1800	505
EMP.D.3.53137-18-4	530x1370x1800	545
EMP.D.3.53152-18-4	530x1520x1800	581
EMP.D.3.53183-18-4	530x1830x1800	660

INOX 201

Kod Code	Ebatlar Dimension mm	Fiyatı Price Euro
EMP.D.2.5376-18-4	530x760x1800	316
EMP.D.2.5391-18-4	530x910x1800	344
EMP.D.2.53107-18-4	530x1070x1800	376
EMP.D.2.53122-18-4	530x1220x1800	408
EMP.D.2.53137-18-4	530x1370x1800	436
EMP.D.2.53152-18-4	530x1520x1800	468
EMP.D.2.53183-18-4	530x1830x1800	528

Kod Code	Ebatlar Dimension mm	Fiyatı Price Euro
EMP.D.3.6176-18-4	610x760x1800	409
EMP.D.3.6191-18-4	610x910x1800	452
EMP.D.3.61107-18-4	610x1070x1800	495
EMP.D.3.61122-18-4	610x1220x1800	538
EMP.D.3.61137-18-4	610x1370x1800	578
EMP.D.3.61152-18-4	610x1520x1800	621
EMP.D.3.61183-18-4	610x1830x1800	706

Kod Code	Ebatlar Dimension mm	Fiyatı Price Euro
EMP.D.2.6176-18-4	610x760x1800	332
EMP.D.2.6191-18-4	610x910x1800	364
EMP.D.2.61107-18-4	610x1070x1800	396
EMP.D.2.61122-18-4	610x1220x1800	428
EMP.D.2.61137-18-4	610x1370x1800	464
EMP.D.2.61152-18-4	610x1520x1800	496
EMP.D.2.61183-18-4	610x1830x1800	564

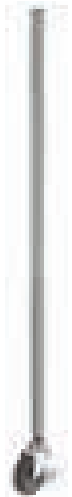

Delikli Raflar
Perforated Shelves



INOX 304

INOX 201

Kod Code	Ebatlar Dimension mm	Fiyatı Price Euro
EMP.D.3.3676-D	360x760	59
EMP.D.3.3691-D	360x910	67
EMP.D.3.36107-D	360x1070	76
EMP.D.3.36122-D	360x1220	84
EMP.D.3.36137-D	360x1370	92
EMP.D.3.36152-D	360x1520	100
EMP.D.3.36183-D	360x1830	117

Kod Code	Ebatlar Dimension mm	Fiyatı Price Euro
EMP.D.2.3676-D	360x760	50
EMP.D.2.3691-D	360x910	56
EMP.D.2.36107-D	360x1070	63
EMP.D.2.36122-D	360x1220	70
EMP.D.2.36137-D	360x1370	76
EMP.D.2.36152-D	360x1520	82
EMP.D.2.36183-D	360x1830	96

Kod Code	Ebatlar Dimension mm	Fiyatı Price Euro
EMP.D.3.4676-D	460x760	66
EMP.D.3.4691-D	460x910	75
EMP.D.3.46107-D	460x1070	85
EMP.D.3.46122-D	460x1220	95
EMP.D.3.46137-D	460x1370	104
EMP.D.3.46152-D	460x1520	114
EMP.D.3.46183-D	460x1830	133

Kod Code	Ebatlar Dimension mm	Fiyatı Price Euro
EMP.D.2.4676-D	460x760	55
EMP.D.2.4691-D	460x910	63
EMP.D.2.46107-D	460x1070	71
EMP.D.2.46122-D	460x1220	78
EMP.D.2.46137-D	460x1370	86
EMP.D.2.46152-D	460x1520	93
EMP.D.2.46183-D	460x1830	108

INOX 304

INOX 201

Kod Code	Ebatlar Dimension mm	Fiyatı Price Euro
EMP.1600-3	1600	29
EMP.1800-3	1800	32
EMP.1600-3-H	1600	45
EMP.1800-3-H	1800	49

Kod Code	Ebatlar Dimension mm	Fiyatı Price Euro
EMP.1600-2	1600	23
EMP.1800-2	1800	24
EMP.1600-2-H	1600	39
EMP.1800-2-H	1800	41

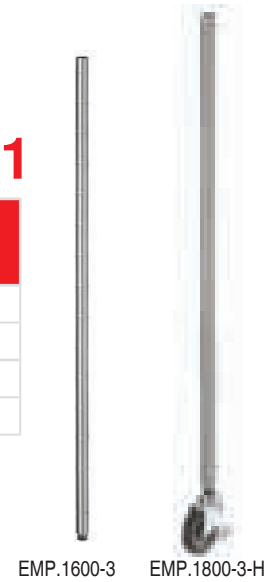

EMP.1600-3 EMP.1800-3-H

Delikli Raflar
Perforated Shelves



INOX 304

Kod Code	Ebatlar Dimension mm	Fiyatı Price Euro
EMP.D.3.5376-D	530x760	72
EMP.D.3.5391-D	530x910	81
EMP.D.3.53107-D	530x1070	92
EMP.D.3.53122-D	530x1220	102
EMP.D.3.53137-D	530x1370	113
EMP.D.3.53152-D	530x1520	122
EMP.D.3.53183-D	530x1830	144

INOX 201

Kod Code	Ebatlar Dimension mm	Fiyatı Price Euro
EMP.D.2.5376-D	530x760	59
EMP.D.2.5391-D	530x910	67
EMP.D.2.53107-D	530x1070	76
EMP.D.2.53122-D	530x1220	84
EMP.D.2.53137-D	530x1370	92
EMP.D.2.53152-D	530x1520	100
EMP.D.2.53183-D	530x1830	117

Kod Code	Ebatlar Dimension mm	Fiyatı Price Euro
EMP.D.3.6176-D	610x760	76
EMP.D.3.6191-D	610x910	88
EMP.D.3.61107-D	610x1070	99
EMP.D.3.61122-D	610x1220	111
EMP.D.3.61137-D	610x1370	122
EMP.D.3.61152-D	610x1520	133
EMP.D.3.61183-D	610x1830	156

Kod Code	Ebatlar Dimension mm	Fiyatı Price Euro
EMP.D.2.6176-D	610x760	63
EMP.D.2.6191-D	610x910	72
EMP.D.2.61107-D	610x1070	81
EMP.D.2.61122-D	610x1220	90
EMP.D.2.61137-D	610x1370	99
EMP.D.2.61152-D	610x1520	108
EMP.D.2.61183-D	610x1830	127

Delikli Raflar 4 Katlı (1600 mm)
Perforated Shelves With 4 Floor (1600 mm)



INOX 304

INOX 201

Kod Code	Ebatlar Dimension mm	Fiyatı Price Euro
EMP.D.3.3676-16-4-D	360x760x1600	352
EMP.D.3.3691-16-4-D	360x910x1600	384
EMP.D.3.36107-16-4-D	360x1070x1600	420
EMP.D.3.36122-16-4-D	360x1220x1600	452
EMP.D.3.36137-16-4-D	360x1370x1600	484
EMP.D.3.36152-16-4-D	360x1520x1600	516
EMP.D.3.36183-16-4-D	360x1830x1600	584

Kod Code	Ebatlar Dimension mm	Fiyatı Price Euro
EMP.D.2.3676-16-4-D	360x760x1600	292
EMP.D.2.3691-16-4-D	360x910x1600	317
EMP.D.2.36107-16-4-D	360x1070x1600	346
EMP.D.2.36122-16-4-D	360x1220x1600	371
EMP.D.2.36137-16-4-D	360x1370x1600	396
EMP.D.2.36152-16-4-D	360x1520x1600	421
EMP.D.2.36183-16-4-D	360x1830x1600	475

Kod Code	Ebatlar Dimension mm	Fiyatı Price Euro
EMP.D.3.4676-16-4-D	460x760x1600	381
EMP.D.3.4691-16-4-D	460x910x1600	416
EMP.D.3.46107-16-4-D	460x1070x1600	456
EMP.D.3.46122-16-4-D	460x1220x1600	495
EMP.D.3.46137-16-4-D	460x1370x1600	531
EMP.D.3.46152-16-4-D	460x1520x1600	570
EMP.D.3.46183-16-4-D	460x1830x1600	649

Kod Code	Ebatlar Dimension mm	Fiyatı Price Euro
EMP.D.2.4676-16-4-D	460x760x1600	314
EMP.D.2.4691-16-4-D	460x910x1600	342
EMP.D.2.46107-16-4-D	460x1070x1600	374
EMP.D.2.46122-16-4-D	460x1220x1600	403
EMP.D.2.46137-16-4-D	460x1370x1600	435
EMP.D.2.46152-16-4-D	460x1520x1600	464
EMP.D.2.46183-16-4-D	460x1830x1600	525

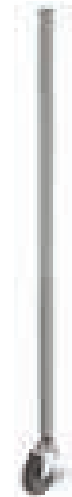

Delikli Raflar 4 Katlı (1600 mm)
Perforated Shelves With 4 Floor (1600 mm)

INOX 304

Kod Code	Ebatlar Dimension mm	Fiyatı Price Euro
EMP.D.3.5376-16-4-D	530x760x1600	402
EMP.D.3.5391-16-4-D	530x910x1600	441
EMP.D.3.53107-16-4-D	530x1070x1600	484
EMP.D.3.53122-16-4-D	530x1220x1600	524
EMP.D.3.53137-16-4-D	530x1370x1600	566
EMP.D.3.53152-16-4-D	530x1520x1600	606
EMP.D.3.53183-16-4-D	530x1830x1600	692

INOX 201

Kod Code	Ebatlar Dimension mm	Fiyatı Price Euro
EMP.D.2.5376-16-4-D	530x760x1600	328
EMP.D.2.5391-16-4-D	530x910x1600	360
EMP.D.2.53107-16-4-D	530x1070x1600	396
EMP.D.2.53122-16-4-D	530x1220x1600	428
EMP.D.2.53137-16-4-D	530x1370x1600	460
EMP.D.2.53152-16-4-D	530x1520x1600	492
EMP.D.2.53183-16-4-D	530x1830x1600	560

Kod Code	Ebatlar Dimension mm	Fiyatı Price Euro
EMP.D.3.6176-16-4-D	610x760x1600	420
EMP.D.3.6191-16-4-D	610x910x1600	466
EMP.D.3.61107-16-4-D	610x1070x1600	513
EMP.D.3.61122-16-4-D	610x1220x1600	559
EMP.D.3.61137-16-4-D	610x1370x1600	602
EMP.D.3.61152-16-4-D	610x1520x1600	649
EMP.D.3.61183-16-4-D	610x1830x1600	742

Kod Code	Ebatlar Dimension mm	Fiyatı Price Euro
EMP.D.2.6176-16-4-D	610x760x1600	346
EMP.D.2.6191-16-4-D	610x910x1600	382
EMP.D.2.61107-16-4-D	610x1070x1600	417
EMP.D.2.61122-16-4-D	610x1220x1600	453
EMP.D.2.61137-16-4-D	610x1370x1600	489
EMP.D.2.61152-16-4-D	610x1520x1600	525
EMP.D.2.61183-16-4-D	610x1830x1600	600

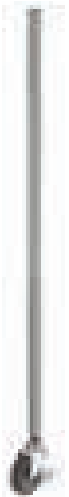

Delikli Raflar 4 Katlı (1800 mm)
Perforated Shelves With 4 Floor (1800 mm)



INOX 304

Kod Code	Ebatlar Dimension mm	Fiyatı Price Euro
EMP.D.3.3676-18-4-D	360x760x1800	364
EMP.D.3.3691-18-4-D	360x910x1800	396
EMP.D.3.36107-18-4-D	360x1070x1800	432
EMP.D.3.36122-18-4-D	360x1220x1800	464
EMP.D.3.36137-18-4-D	360x1370x1800	496
EMP.D.3.36152-18-4-D	360x1520x1800	528
EMP.D.3.36183-18-4-D	360x1830x1800	596

INOX 201

Kod Code	Ebatlar Dimension mm	Fiyatı Price Euro
EMP.D.2.3676-18-4-D	360x760x1800	296
EMP.D.2.3691-18-4-D	360x910x1800	321
EMP.D.2.36107-18-4-D	360x1070x1800	350
EMP.D.2.36122-18-4-D	360x1220x1800	375
EMP.D.2.36137-18-4-D	360x1370x1800	400
EMP.D.2.36152-18-4-D	360x1520x1800	425
EMP.D.2.36183-18-4-D	360x1830x1800	479

Kod Code	Ebatlar Dimension mm	Fiyatı Price Euro
EMP.D.3.4676-18-4-D	460x760x1800	393
EMP.D.3.4691-18-4-D	460x910x1800	428
EMP.D.3.46107-18-4-D	460x1070x1800	468
EMP.D.3.46122-18-4-D	460x1220x1800	507
EMP.D.3.46137-18-4-D	460x1370x1800	543
EMP.D.3.46152-18-4-D	460x1520x1800	582
EMP.D.3.46183-18-4-D	460x1830x1800	661

Kod Code	Ebatlar Dimension mm	Fiyatı Price Euro
EMP.D.2.4676-18-4-D	460x760x1800	318
EMP.D.2.4691-18-4-D	460x910x1800	346
EMP.D.2.46107-18-4-D	460x1070x1800	378
EMP.D.2.46122-18-4-D	460x1220x1800	407
EMP.D.2.46137-18-4-D	460x1370x1800	439
EMP.D.2.46152-18-4-D	460x1520x1800	468
EMP.D.2.46183-18-4-D	460x1830x1800	529

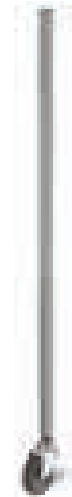

Delikli Raflar 4 Katlı (1800 mm)
Perforated Shelves With 4 Floor (1800 mm)

INOX 304

Kod Code	Ebatlar Dimension mm	Fiyatı Price Euro
EMP.D.3.5376-18-4-D	530x760x1800	414
EMP.D.3.5391-18-4-D	530x910x1800	453
EMP.D.3.53107-18-4-D	530x1070x1800	496
EMP.D.3.53122-18-4-D	530x1220x1800	536
EMP.D.3.53137-18-4-D	530x1370x1800	578
EMP.D.3.53152-18-4-D	530x1520x1800	618
EMP.D.3.53183-18-4-D	530x1830x1800	704

INOX 201

Kod Code	Ebatlar Dimension mm	Fiyatı Price Euro
EMP.D.2.5376-18-4-D	530x760x1800	332
EMP.D.2.5391-18-4-D	530x910x1800	364
EMP.D.2.53107-18-4-D	530x1070x1800	400
EMP.D.2.53122-18-4-D	530x1220x1800	432
EMP.D.2.53137-18-4-D	530x1370x1800	464
EMP.D.2.53152-18-4-D	530x1520x1800	496
EMP.D.2.53183-18-4-D	530x1830x1800	564

Kod Code	Ebatlar Dimension mm	Fiyatı Price Euro
EMP.D.3.6176-18-4-D	610x760x1800	432
EMP.D.3.6191-18-4-D	610x910x1800	478
EMP.D.3.61107-18-4-D	610x1070x1800	525
EMP.D.3.61122-18-4-D	610x1220x1800	571
EMP.D.3.61137-18-4-D	610x1370x1800	614
EMP.D.3.61152-18-4-D	610x1520x1800	661
EMP.D.3.61183-18-4-D	610x1830x1800	754

Kod Code	Ebatlar Dimension mm	Fiyatı Price Euro
EMP.D.2.6176-18-4-D	610x760x1800	350
EMP.D.2.6191-18-4-D	610x910x1800	386
EMP.D.2.61107-18-4-D	610x1070x1800	421
EMP.D.2.61122-18-4-D	610x1220x1800	457
EMP.D.2.61137-18-4-D	610x1370x1800	493
EMP.D.2.61152-18-4-D	610x1520x1800	529
EMP.D.2.61183-18-4-D	610x1830x1800	604

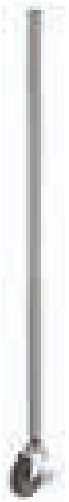

Mutfak Bulaşık Arabaları
Soiled Dish Trolleys

DEMONTE

Stainless Steel / Paslanmaz Çelik

Kod Code	Ürün Adı Description	Ebatlar Dimension mm	Kapasite Capacity Tepsi/Tray	Fiyatı Price Euro
EMP.BA.2.3753-13	Bulaşık Toplama , Selfrom 37x53 Tekli Tray Trolley, With Rails-Single Row, For 37x53	430x560x1710	13-15	315
EMP.BA.2.3753-26	Bulaşık Toplama , Selfrom 37x53 İkili Tray Trolley, With Rails-Twin Row, For 37x53	830x560x1710	26-30	500
EMP.BA.2.3753-39	Bulaşık Toplama , Selfrom 37x53 Üçlü Tray Trolley, With Rails-Triple Row, For 37x53	1230x560x1710	39-45	700

Bardak tepsili / With glass tray on top



Kod Code	Ürün Adı Description	Ebatlar Dimension mm	Kapasite Capacity Gn 1/1	Fiyatı Price Euro
EMP.BA.2.GN-9	Tepsi Taşıma Alçak- Tekli Gn 1/1 Gn Trolley Low-Single Gn 1/1	380x560x1050	9	210
EMP.BA.2.GN-17	Tepsi Taşıma Yüksek- Tekli Gn 1/1 Gn Trolley High-Single Gn 1/1	380x560x1720	17	270
EMP.BA.2.GN-34	Tepsi Taşıma Yüksek-İkili Gn 1/1 Gn Trolley High-Twin Gn 1/1	740x560x1720	34	440

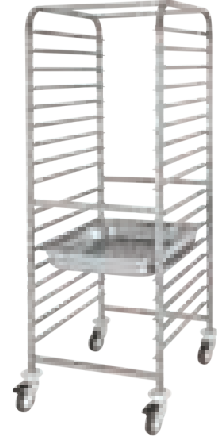

Kod Code	Ürün Adı Description	Ebatlar Dimension mm	Kapasite Capacity Gn 2/1	Fiyatı Price Euro
EMP.BA.2.GN2-9	Tepsi Taşıma Alçak- Tekli Gn 2/1 Gn Trolley Low-Single Gn 2/1	590x680x1050	9	250
EMP.BA.2.GN2-17	Tepsi Taşıma Yüksek- Tekli Gn 2/1 Gn Trolley High-Single Gn 2/1	590x680x1720	17	315
EMP.BA.2.GN2-34	Tepsi Taşıma Yüksek-İkili Gn 2/1 Gn Trolley High-Twin Gn 2/1	1150x680x1720	34	500

304 Kalite istenirse fiyata %20 ilave ediniz
%20 add on list price for 304 quality

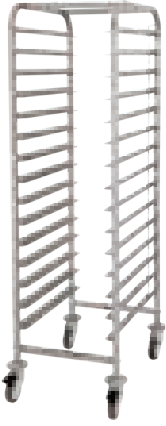
Mutfak Bulaşık Arabaları
Soiled Dish Trolleys

Stainless Steel / Paslanmaz Çelik

DEMONTE

Kod Code	Ürün Adı Description	Ebatlar Dimension mm	Kapasite Capacity Tepsi/Tray	Fiyatı Price Euro
EMP.TT.2.6040	Tepsi Taşıma- 60x40 Tepsiye Göre-Tekli Tray Trolley For 60x40 Tray-Single	460x630x1650	15	315
EMP.2TT.2.6040	Tepsi Taşıma, 60x40 Tepsiye Göre-İkili Tray Trolley For 60x40 Tray-Twin	900x630x1650	30	560



Kod Code	Ürün Adı Description	Ebatlar Dimension mm	Fiyatı Price Euro
EMP.TT.2.7050	Tepsi Taşıma-70x50 Tepsiye Göre Tray Trolley For 70x50 Tray	560x730x1700	325



Kod Code	Ürün Adı Description	Ebatlar Dimension mm	Fiyatı Price Euro
EMP.BAKA.2.5	Kaset Taşıma-Alçak Basket Trolley With Rails-Low	560x530x900	195

5 Kaset, Kapasiteli / 5 Cassette Capacity
Kasetler Hariçtir / Excluding tapes



Kod Code	Ürün Adı Description	Ebatlar Dimension mm	Fiyatı Price Euro
EMP.BAKY.2.10	Kaset Taşıma-Yüksek Basket Trolley With-High	560x530x1650	260

10 Kaset, Kapasiteli / 10 Cassette Capacity

304 Kalite istenirse fiyata %20 ilave ediniz
%20 add on list price for 304 quality

Servis Arabaları
Service Trolleys

DEMONTE

Stainless Steel / Paslanmaz Çelik

Kod Code	Ürün Adı Description	Ebatlar Dimension mm	Fiyatı Price Euro
EMP.BAH.2.8555-90	Bulaşık Toplama-Havuzlu Tray Clearing Trolley	850x550x900	275



Kod Code	Ürün Adı Description	Ebatlar Dimension mm	Fiyatı Price Euro
EMP.BAKT.2.5555-90	Kaset Taşıma-Kollu Basket Trolley With Handle	550x550x900	120



304 Kalite istenirse fiyata %20 ilave ediniz
%20 add on list price for 304 quality

Taşıma ve Muhafaza Arabaları
Mobile Storage Bins and Transport Carts

Stainless Steel / Paslanmaz Çelik

Kod Code	Ürün Adı Description	Ebatlar Dimension mm	Fiyatı Price Euro
EMP. BAKTT.2.906050-90	Kazan-Tencere Taşıma Boiler, Cooker Transport	900x600x500/900	260

Platform Yüksek / Platform Trolley High



Kod Code	Ürün Adı Description	Ebatlar Dimension mm	Fiyatı Price Euro
EMP.TA.2.1055-17	Et Askı Arabası Carcass Hanger	1000x550x1700	415
EMP.TA.2.1255-17	Et Askı Arabası Carcass Hanger	1200x550x1700	450
EMP.TA.2.1555-17	Et Askı Arabası Carcass Hanger	1500x550x1700	480



Kod Code	Ürün Adı Description	Ebatlar Dimension mm	Fiyatı Price Euro
EMP.PD.2.806020-90	Platform-Düz Platform Trolley, Solid	800x600x200 / 900	250

Kasetler Hariçtir / Baskets not included

Taşıma ve Muhafaza Arabaları
Mobile Storage Bins and Transport Carts

Kod Code	Ürün Adı Description	Ebatlar Dimension mm	Tipi Type	Fiyatı Price Euro
EMP.CY.01	Çöp Yuvarlak Mobile Waste Bin-Round	Ø 400x400	INOX 304	170

Pres Baskı / Pressed



Kod Code	Ürün Adı Description	Ebatlar Dimension mm	Tipi Type	Fiyatı Price Euro
EMP.CK.01	Çöp Kare Mobile Waste Bin, Square	500x550x500	INOX 304	260

Pres Baskı / Pressed



Kod Code	Ürün Adı Description	Ebatlar Dimension mm	Tipi Type	Fiyatı Price Euro
EMP.ECK.3.8454-58	Erzak-Çift Kapaklı Mobile Bin Double Lid	840x540x580	INOX 304	360

Pres Baskı / Pressed



Tabak Otomatları
Plate Dispensers

Kod Code	Ürün Adı Description	Ebatlar Dimension mm	Fiyatı Price Euro
EMP.TO.1826-N-1	Tabak Otomatı Tekli - 18 / 26 Plate Dispenser - Single	Nötr / Neutral 440x500x900	370
EMP.TO.1826-I-1	Tabak Otomatı Tekli - 18 / 26 Plate Dispenser - Single	Isıtmalı / Heating 440x500x900	410
EMP.TO.2432-N-1	Tabak Otomatı Tekli - 24 / 32 Plate Dispenser - Single	Nötr / Neutral 480x550x900	420
EMP.TO.2432-I-1	Tabak Otomatı Tekli - 24 / 32 Plate Dispenser - Single	Isıtmalı / Heating 480x550x900	460

Tabaklar hariçtir / Plates not included



Kod Code	Ürün Adı Description	Ebatlar Dimension mm	Fiyatı Price Euro
EMP.TO.1826-N-2	Tabak Otomatı İkili - 18 / 26 Plate Dispenser - Double	Nötr / Neutral 440x880x900	600
EMP.TO.1826-I-2	Tabak Otomatı İkili - 18 / 26 Plate Dispenser - Double	Isıtmalı / Heating 440x880x900	700
EMP.TO.2432-N-2	Tabak Otomatı İkili - 24 / 32 Plate Dispenser - Double	Nötr / Neutral 480x1000x900	660
EMP.TO.2432-I-2	Tabak Otomatı İkili - 24 / 32 Plate Dispenser - Double	Isıtmalı / Heating 480x1000x900	750

Tabaklar hariçtir / Plates not included



Kod Code	Ürün Adı Description	Ebatlar Dimension mm	Fiyatı Price Euro
EMP.TO.1826-N	Tabak Kartuşu - 18 / 26 Plate Dispensing Cartridge	Nötr / Neutral 380x380x750	185
EMP.TO.1826-I	Tabak Kartuşu - 18 / 26 Plate Dispensing Cartridge	Isıtmalı / Heating 380x380x750	225
EMP.TO.2432-N	Tabak Kartuşu - 24 / 32 Plate Dispensing Cartridge	Nötr / Neutral 440x440x750	200
EMP.TO.2432-I	Tabak Kartuşu - 24 / 32 Plate Dispensing Cartridge	Isıtmalı / Heating 440x440x750	240

Tabaklar hariçtir / Plates not included

Yer Filtreleri Altan Çıkışı

Floor Filters Bottom Outlet



Kod Code	Ürün Adı Description	Ebatlar Dimension mm	Fiyatı Price Euro
EMP.YF.AO.3030	Altan Çıkışlı Ortadan Sifonlu / Bottom Outlet Center Drain	300x300x150	150
EMP.YF.AO.3050	Altan Çıkışlı Ortadan Sifonlu / Bottom Outlet Center Drain	300x500x150	190
EMP.YF.AO.3074	Altan Çıkışlı Ortadan Sifonlu / Bottom Outlet Center Drain	300x740x150	230
EMP.YF.AO.3094	Altan Çıkışlı Ortadan Sifonlu / Bottom Outlet Center Drain	300x940x150	310
EMP.YF.AO.30118	Altan Çıkışlı Ortadan Sifonlu / Bottom Outlet Center Drain	300x1180x150	360
EMP.YF.AO.30138	Altan Çıkışlı Ortadan Sifonlu / Bottom Outlet Center Drain	300x1380x150	380
EMP.YF.AO.30161	Altan Çıkışlı Ortadan Sifonlu / Bottom Outlet Center Drain	300x1610x150	440
EMP.YF.AO.30181	Altan Çıkışlı Ortadan Sifonlu / Bottom Outlet Center Drain	300x1810x150	500
EMP.YF.AO.30205	Altan Çıkışlı Ortadan Sifonlu / Bottom Outlet Center Drain	300x2050x150	545
EMP.YF.AO.30225	Altan Çıkışlı Ortadan Sifonlu / Bottom Outlet Center Drain	300x2250x150	600
EMP.YF.AO.30249	Altan Çıkışlı Ortadan Sifonlu / Bottom Outlet Center Drain	300x2490x150	690

Çıkış çapı : 74mm
Outlet Diameter : 74mm

Yer Filtreleri Yandan Çıkışı

Floor Filters Side Outlet



Kod Code	Ürün Adı Description	Ebatlar Dimension mm	Fiyatı Price Euro
EMP.YF.YO.3030	Yandan Çıkışlı Ortadan Sifonlu / Side Outlet Center Drain	300x300x150	130
EMP.YF.YO.3050	Yandan Çıkışlı Ortadan Sifonlu / Side Outlet Center Drain	300x500x150	175
EMP.YF.YO.3074	Yandan Çıkışlı Ortadan Sifonlu / Side Outlet Center Drain	300x740x150	230
EMP.YF.YO.3094	Yandan Çıkışlı Ortadan Sifonlu / Side Outlet Center Drain	300x940x150	290
EMP.YF.YO.30118	Yandan Çıkışlı Ortadan Sifonlu / Side Outlet Center Drain	300x1180x150	330
EMP.YF.YO.30138	Yandan Çıkışlı Ortadan Sifonlu / Side Outlet Center Drain	300x1380x150	400
EMP.YF.YO.30161	Yandan Çıkışlı Ortadan Sifonlu / Side Outlet Center Drain	300x1610x150	440
EMP.YF.YO.30181	Yandan Çıkışlı Ortadan Sifonlu / Side Outlet Center Drain	300x1810x150	490
EMP.YF.YO.30205	Yandan Çıkışlı Ortadan Sifonlu / Side Outlet Center Drain	300x2050x150	520
EMP.YF.YO.30225	Yandan Çıkışlı Ortadan Sifonlu / Side Outlet Center Drain	300x2250x150	600
EMP.YF.YO.30249	Yandan Çıkışlı Ortadan Sifonlu / Side Outlet Center Drain	300x2490x150	650

Çıkış çapı : 74mm
Outlet Diameter : 74mm

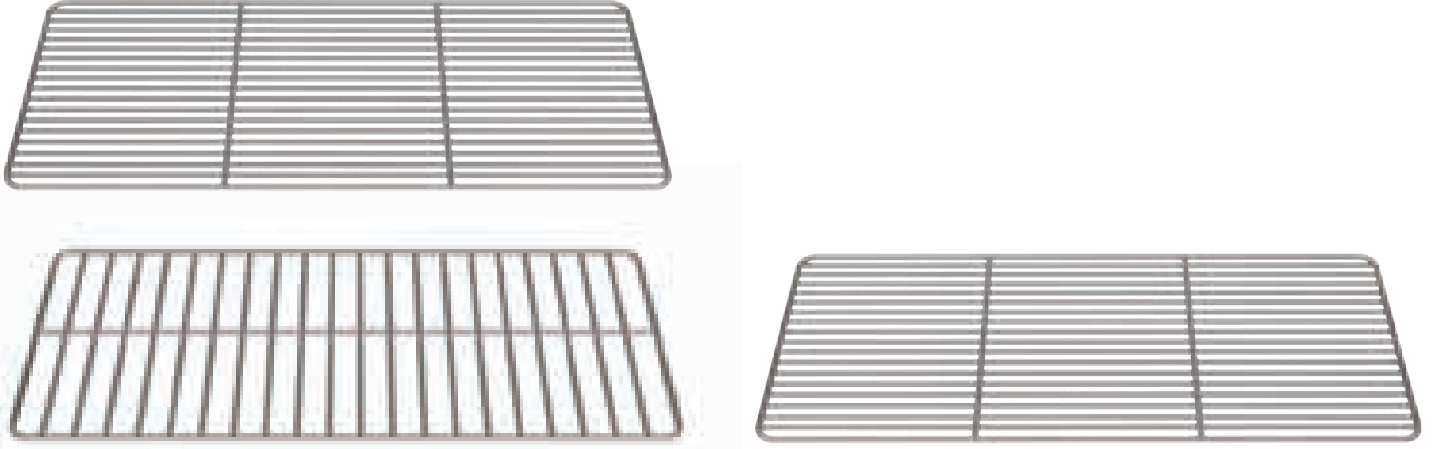
Tel Izgaralar
Wire Grid

INOX 304

Kod Code	Ürün Adı Description	Ebatlar Dimension mm	Fiyatı Price Euro
EMP.3.530325	Tel Izgara GN 1/1 Wire Grid GN 1/1	530x325	13
EMP.3.650530	Tel Izgara GN 2/1 Wire Grid GN 2/1	650x530	25
EMP.3.600400	Tel Izgara Wire Grid	600x400	17

INOX 201

Kod Code	Ürün Adı Description	Ebatlar Dimension mm	Fiyatı Price Euro
EMP.2.530325	Tel Izgara GN 1/1 Wire Grid GN 1/1	530x325	10
EMP.2.650530	Tel Izgara GN 2/1 Wire Grid GN 2/1	650x530	16
EMP.2.600400	Tel Izgara Wire Grid	600x400	12

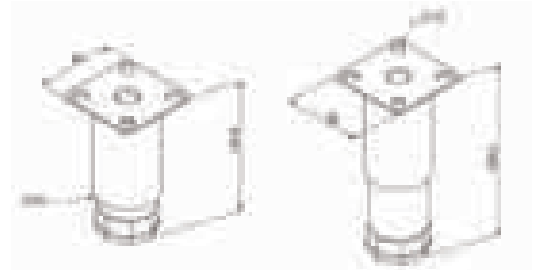

Boru Ayak / Foot

Kod Code	Ürün Adı Description	Ebatlar Dimension mm	Fiyatı Price Euro
EMP.BRA.150	Boru Ayak Foot	150	7

Davlumbaz Filtreleri Hood Filters

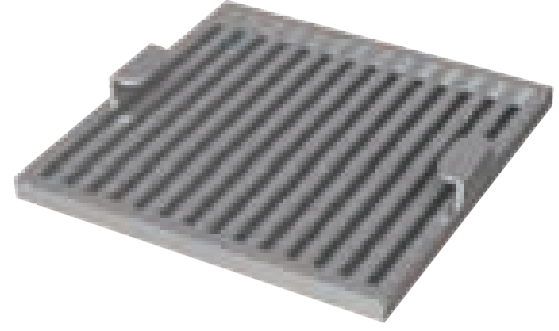

Kod Code	Ürün Adı Description	Ebatlar Dimension mm	Fiyatı Price Euro
EMP.4.55	Davlumbaz Filtresi Filter For Hood	500x500	26

430 Kalite parlak yüzey / AISI 430 Stainless Steel Polished



Yağ Ayırıcı Grease Seperator

Kod Code	Ürün Adı Description	Ebatlar Dimension mm	Ağırlık Weight kg	Kapasite Capacity lt	Fiyatı Price Euro
EMP.YT.01	Yağ Ayırıcı Grease Seperator	655x340x290	20	10	440
EMP.YT.02	Yağ Ayırıcı Grease Seperator	730x413x420	29	16	520
EMP.YT.03	Yağ Ayırıcı Grease Seperator	900x540x640	52	50	600



Çalışma Tezgahları Work Table

- * Çalışma Tezgahı (Demonte) / Work Table (Demontable)
- * Çalışma Tezgahı Alt Rafı (Demonte) / Work Table With Bottom Shelf (Demontable)
- * Çalışma Tezgahı Alt - Ara Rafı (Demonte) / Work Table With Bottom - Intermediate Shelf (Demontable)
- * Çalışma Tezgahı Polietilen (Demonte) / Work Table Polyethylen (Demontable)
- * Çalışma Tezgahı Alt Rafı Polietilen (Demonte) / Work Table With Bottom Shelf Polyethylen (Demontable)
- * Dolaplı Çalışma Tezgahı (Kaynaklı) / Work Table Cabinet (Welded)
- * Dolaplı Çalışma Tezgahı Ara Rafı (Kaynaklı) / Work Table Cabinet - Intermediate Shelf (Welded)
- * Blok Çekmece Ünitesi / Drawers Unit

Çalışma Tezgahı (Demonte)
Work Table (Demontable)



60'lık Seri / 60's Series

Kod Code	Ürün Adı Description	Ebatlar Dimension mm	Fiyatı Price Euro
EMP.AT.6080	Çalışma Tezgahı Work Table	800x600x850	200
EMP.AT.60100	Çalışma Tezgahı Work Table	1000x600x850	220
EMP.AT.60120	Çalışma Tezgahı Work Table	1200x600x850	250
EMP.AT.60140	Çalışma Tezgahı Work Table	1400x600x850	275
EMP.AT.60160	Çalışma Tezgahı Work Table	1600x600x850	300
EMP.AT.60180	Çalışma Tezgahı Work Table	1800x600x850	325
EMP.AT.60200	Çalışma Tezgahı Work Table	2000x600x850	350
EMP.AT.60220	Çalışma Tezgahı Work Table	2200x600x850	400
EMP.AT.60240	Çalışma Tezgahı Work Table	2400x600x850	420

70'lık Seri / 70's Series

Kod Code	Ürün Adı Description	Ebatlar Dimension mm	Fiyatı Price Euro
EMP.AT.7080	Çalışma Tezgahı Work Table	800x700x850	210
EMP.AT.70100	Çalışma Tezgahı Work Table	1000x700x850	235
EMP.AT.70120	Çalışma Tezgahı Work Table	1200x700x850	265
EMP.AT.70140	Çalışma Tezgahı Work Table	1400x700x850	290
EMP.AT.70160	Çalışma Tezgahı Work Table	1600x700x850	315
EMP.AT.70180	Çalışma Tezgahı Work Table	1800x700x850	340
EMP.AT.70200	Çalışma Tezgahı Work Table	2000x700x850	370
EMP.AT.70220	Çalışma Tezgahı Work Table	2200x700x850	420
EMP.AT.70240	Çalışma Tezgahı Work Table	2400x700x850	450

Köşe Tezgahları / Corner Table

Kod Code	Ürün Adı Description	Ebatlar Dimension mm	Fiyatı Price Euro
EMP.KST.6060-L	Köşe Tezgahı Sol Corner Table Left	600x600x850	125
EMP.KST.6060-R	Köşe Tezgahı Sağ Corner Table Right	600x600x850	125
EMP.KST.7070-L	Köşe Tezgahı Sol Corner Table Left	700x700x850	150
EMP.KST.7070-R	Köşe Tezgahı Sağ Corner Table Right	700x700x850	150



• Ürün siparişlerinizde sırt yönünü belirtiniz. / Please, specify direction of back with the order.

- Tüm ürünler demonte olup, paslanmaz çelikten üretilmektedir.
- Tezgahlar standart olarak sırtlı üretilmektedir.
- Arkası sırtsız tezgahları lütfen bildirin.
- Tezgahlar ayarlanabilir ayaklıdır.

- All products are demontable and stainless steel.
- Tables are produced with back standarty.
- Please specify if you don't want back with the table.
- All tables are adjustable feet.

Çalışma Tezgahı Alt Rafı (Demonte)
Work Table With Bottom Shelf (Demontable)



60'lık Seri / 60's Series

70'lık Seri / 70's Series

Kod Code	Ürün Adı Description	Ebatlar Dimension mm	Fiyatı Price Euro
EMP.ATT.6080	Çalışma Tezgahı Alt Rafı Work Table With Bottom Shelf	800x600x850	220
EMP.ATT.60100	Çalışma Tezgahı Alt Rafı Work Table With Bottom Shelf	1000x600x850	250
EMP.ATT.60120	Çalışma Tezgahı Alt Rafı Work Table With Bottom Shelf	1200x600x850	275
EMP.ATT.60140	Çalışma Tezgahı Alt Rafı Work Table With Bottom Shelf	1400x600x850	310
EMP.ATT.60160	Çalışma Tezgahı Alt Rafı Work Table With Bottom Shelf	1600x600x850	350
EMP.ATT.60180	Çalışma Tezgahı Alt Rafı Work Table With Bottom Shelf	1800x600x850	380
EMP.ATT.60200	Çalışma Tezgahı Alt Rafı Work Table With Bottom Shelf	2000x600x850	410
EMP.ATT.60220	Çalışma Tezgahı Alt Rafı Work Table With Bottom Shelf	2200x600x850	470
EMP.ATT.60240	Çalışma Tezgahı Alt Rafı Work Table With Bottom Shelf	2400x600x850	500

Kod Code	Ürün Adı Description	Ebatlar Dimension mm	Fiyatı Price Euro
EMP.ATT.7080	Çalışma Tezgahı Alt Rafı Work Table With Bottom Shelf	800x700x850	230
EMP.ATT.70100	Çalışma Tezgahı Alt Rafı Work Table With Bottom Shelf	1000x700x850	265
EMP.ATT.70120	Çalışma Tezgahı Alt Rafı Work Table With Bottom Shelf	1200x700x850	300
EMP.ATT.70140	Çalışma Tezgahı Alt Rafı Work Table With Bottom Shelf	1400x700x850	335
EMP.ATT.70160	Çalışma Tezgahı Alt Rafı Work Table With Bottom Shelf	1600x700x850	375
EMP.ATT.70180	Çalışma Tezgahı Alt Rafı Work Table With Bottom Shelf	1800x700x850	410
EMP.ATT.70200	Çalışma Tezgahı Alt Rafı Work Table With Bottom Shelf	2000x700x850	465
EMP.ATT.70220	Çalışma Tezgahı Alt Rafı Work Table With Bottom Shelf	2200x700x850	500
EMP.ATT.70240	Çalışma Tezgahı Alt Rafı Work Table With Bottom Shelf	2400x700x850	535

Köşe Tezgahı Alt Rafı / Corner Table With Bottom Shelf



Kod Code	Ürün Adı Description	Ebatlar Dimension mm	Fiyatı Price Euro
EMP.KKT.6060-L	Köşe Tezgahı Alt Rafı Sol Corner Table With Bottom Shelf Left	600x600x850	145
EMP.KKT.6060-R	Köşe Tezgahı Alt Rafı Sağ Corner Table With Bottom Shelf Right	600x600x850	145
EMP.KKT.7070-L	Köşe Tezgahı Alt Rafı Sol Corner Table With Bottom Shelf Left	700x700x850	175
EMP.KKT.7070-R	Köşe Tezgahı Alt Rafı Sağ Corner Table With Bottom Shelf Right	700x700x850	175

• Ürün siparişlerinizde sırt yönünü belirtiniz. / Please, specify direction of back with the order.

- Tüm ürünler demonte olup, paslanmaz çelikten üretilmektedir.
- Tezgahlar standart olarak sırtı üretilmektedir.
- Arkası sırsız tezgahları lütfen bildirin.
- Tezgahlar ayarlanabilir ayaklıdır.

- All products are demontable and stainless steel.
- Tables are produced with back standarty.
- Please specify if you don't want back with the table.
- All tables are adjustable feet.

Çalışma Tezgahı Alt - Ara Rafı (Demonte)
Work Table With Bottom - Intermediate Shelf (Demontable)



60'lık Seri / 60's Series

Kod Code	Ürün Adı Description	Ebatlar Dimension mm	Fiyatı Price Euro
EMP.ATT2.6080	Çalışma Tezgahı Alt Rafı-Ara Rafı Work Table With Bottom-Intermediate Shelf	800x600x850	265
EMP.ATT2.60100	Çalışma Tezgahı Alt Rafı-Ara Rafı Work Table With Bottom-Intermediate Shelf	1000x600x850	300
EMP.ATT2.60120	Çalışma Tezgahı Alt Rafı-Ara Rafı Work Table With Bottom-Intermediate Shelf	1200x600x850	335
EMP.ATT2.60140	Çalışma Tezgahı Alt Rafı-Ara Rafı Work Table With Bottom-Intermediate Shelf	1400x600x850	380
EMP.ATT2.60160	Çalışma Tezgahı Alt Rafı-Ara Rafı Work Table With Bottom-Intermediate Shelf	1600x600x850	420
EMP.ATT2.60180	Çalışma Tezgahı Alt Rafı-Ara Rafı Work Table With Bottom-Intermediate Shelf	1800x600x850	465
EMP.ATT2.60200	Çalışma Tezgahı Alt Rafı-Ara Rafı Work Table With Bottom-Intermediate Shelf	2000x600x850	500
EMP.ATT2.60220	Çalışma Tezgahı Alt Rafı-Ara Rafı Work Table With Bottom-Intermediate Shelf	2200x600x850	550
EMP.ATT2.60240	Çalışma Tezgahı Alt Rafı-Ara Rafı Work Table With Bottom-Intermediate Shelf	2400x600x850	590

70'lık Seri / 70's Series

Kod Code	Ürün Adı Description	Ebatlar Dimension mm	Fiyatı Price Euro
EMP.ATT2.7080	Çalışma Tezgahı Alt Rafı-Ara Rafı Work Table With Bottom-Intermediate Shelf	800x700x850	285
EMP.ATT2.70100	Çalışma Tezgahı Alt Rafı-Ara Rafı Work Table With Bottom-Intermediate Shelf	1000x700x850	325
EMP.ATT2.70120	Çalışma Tezgahı Alt Rafı-Ara Rafı Work Table With Bottom-Intermediate Shelf	1200x700x850	370
EMP.ATT2.70140	Çalışma Tezgahı Alt Rafı-Ara Rafı Work Table With Bottom-Intermediate Shelf	1400x700x850	415
EMP.ATT2.70160	Çalışma Tezgahı Alt Rafı-Ara Rafı Work Table With Bottom-Intermediate Shelf	1600x700x850	460
EMP.ATT2.70180	Çalışma Tezgahı Alt Rafı-Ara Rafı Work Table With Bottom-Intermediate Shelf	1800x700x850	500
EMP.ATT2.70200	Çalışma Tezgahı Alt Rafı-Ara Rafı Work Table With Bottom-Intermediate Shelf	2000x700x850	550
EMP.ATT2.70220	Çalışma Tezgahı Alt Rafı-Ara Rafı Work Table With Bottom-Intermediate Shelf	2200x700x850	600
EMP.ATT2.70240	Çalışma Tezgahı Alt Rafı-Ara Rafı Work Table With Bottom-Intermediate Shelf	2400x700x850	650

Köşe Tezgahı Alt - Ara Rafı / Corner Table With Bottom - Intermediate Shelf

Kod Code	Ürün Adı Description	Ebatlar Dimension mm	Fiyatı Price Euro
EMP.KTTA.6060-L	Köşe Tezgahı Alt-Ara Rafı Sol Corner Table With Bottom-Intermediate Shelf Left	600x600x850	195
EMP.KTTA.6060-R	Köşe Tezgahı Alt-Ara Rafı Sağ Corner Table With Bottom-Intermediate Shelf Right	600x600x850	195
EMP.KTTA.7070-L	Köşe Tezgahı Alt-Ara Rafı Sol Corner Table With Bottom-Intermediate Shelf Left	700x700x850	230
EMP.KTTA.7070-R	Köşe Tezgahı Alt-Ara Rafı Sağ Corner Table With Bottom-Intermediate Shelf Right	700x700x850	230



• Ürün siparişlerinizde sırt yönünü belirtiniz. / Please, specify direction of back with the order.

- Tüm ürünler demonte olup, paslanmaz çelikten üretilmektedir.
- Tezgahlar standart olarak sırtlı üretilmektedir.
- Arkası sırtsız tezgahları lütfen bildiriniz.
- Tezgahlar ayarlanabilir ayaklıdır.

- All products are demontable and stainless steel.
- Tables are produced with back standantly.
- Please specify if you don't want back with the table.
- All tables are adjustable feet.

Çalışma Tezgahı Polietilen (Demonte)
Work Table Polyethylen (Demontable)



60'lık Seri / 60's Series

Kod Code	Ürün Adı Description	Ebatlar Dimension mm	Fiyatı Price Euro
EMP.PT.6080	Çalışma Tezgahı Polietilen Work Table Polyethylen	800x600x850	320
EMP.PT.60100	Çalışma Tezgahı Polietilen Work Table Polyethylen	1000x600x850	375
EMP.PT.60120	Çalışma Tezgahı Polietilen Work Table Polyethylen	1200x600x850	430
EMP.PT.60140	Çalışma Tezgahı Polietilen Work Table Polyethylen	1400x600x850	490
EMP.PT.60160	Çalışma Tezgahı Polietilen Work Table Polyethylen	1600x600x850	545
EMP.PT.60180	Çalışma Tezgahı Polietilen Work Table Polyethylen	1800x600x850	600
EMP.PT.60200	Çalışma Tezgahı Polietilen Work Table Polyethylen	2000x600x850	670
EMP.PT.60220	Çalışma Tezgahı Polietilen Work Table Polyethylen	2200x600x850	720
EMP.PT.60240	Çalışma Tezgahı Polietilen Work Table Polyethylen	2400x600x850	780

70'lık Seri / 70's Series

Kod Code	Ürün Adı Description	Ebatlar Dimension mm	Fiyatı Price Euro
EMP.PT.7080	Çalışma Tezgahı Polietilen Work Table Polyethylen	800x700x850	350
EMP.PT.70100	Çalışma Tezgahı Polietilen Work Table Polyethylen	1000x700x850	410
EMP.PT.70120	Çalışma Tezgahı Polietilen Work Table Polyethylen	1200x700x850	480
EMP.PT.70140	Çalışma Tezgahı Polietilen Work Table Polyethylen	1400x700x850	540
EMP.PT.70160	Çalışma Tezgahı Polietilen Work Table Polyethylen	1600x700x850	600
EMP.PT.70180	Çalışma Tezgahı Polietilen Work Table Polyethylen	1800x700x850	670
EMP.PT.70200	Çalışma Tezgahı Polietilen Work Table Polyethylen	2000x700x850	735
EMP.PT.70220	Çalışma Tezgahı Polietilen Work Table Polyethylen	2200x700x850	800
EMP.PT.70240	Çalışma Tezgahı Polietilen Work Table Polyethylen	2400x700x850	860



Polietilen Et Kütüğü / Polyethylen Meat Block

Kod Code	Ürün Adı Description	Ebatlar Dimension mm	Fiyatı Price Euro
EMP.PTE.5050	Polietilen Et Kütüğü Polyethylen Meat Block	500x500x850	285
EMP.PTE.6060	Polietilen Et Kütüğü Polyethylen Meat Block	600x600x850	370

• 10 cm polietilen kalınlığı / 10 cm polyethylen thickness

- Tüm ürünler demonte olup, paslanmaz çelikten üretilmektedir.
- Tezgahlar standart olarak sırtlı üretilmektedir.
- Arkası sırsız tezgahları lütfen bildiriniz.
- Tezgahlar ayarlanabilir ayaklıdır.

- All products are demontable and stainless steel.
- Tables are produced with back standarty.
- Please specify if you don't want back with the table.
- All tables are adjustable feet.

Çalışma Tezgahı Alt Rafı Polietilen (Demonte)
Work Table With Bottom Shelf Polyethylen (Demontable)



60'lık Seri / 60's Series

Kod Code	Ürün Adı Description	Ebatlar Dimension mm	Fiyatı Price Euro
EMP.PTT.6080	Çalışma Tezgahı Alt Rafı Polietilen Work Table With Bottom-Intermediate Shelf	800x600x850	340
EMP.PTT.60100	Çalışma Tezgahı Alt Rafı Polietilen Work Table With Bottom-Intermediate Shelf	1000x600x850	400
EMP.PTT.60120	Çalışma Tezgahı Alt Rafı Polietilen Work Table With Bottom-Intermediate Shelf	1200x600x850	460
EMP.PTT.60140	Çalışma Tezgahı Alt Rafı Polietilen Work Table With Bottom-Intermediate Shelf	1400x600x850	525
EMP.PTT.60160	Çalışma Tezgahı Alt Rafı Polietilen Work Table With Bottom-Intermediate Shelf	1600x600x850	590
EMP.PTT.60180	Çalışma Tezgahı Alt Rafı Polietilen Work Table With Bottom-Intermediate Shelf	1800x600x850	650
EMP.PTT.60200	Çalışma Tezgahı Alt Rafı Polietilen Work Table With Bottom-Intermediate Shelf	2000x600x850	715
EMP.PTT.60220	Çalışma Tezgahı Alt Rafı Polietilen Work Table With Bottom-Intermediate Shelf	2200x600x850	780
EMP.PTT.60240	Çalışma Tezgahı Alt Rafı Polietilen Work Table With Bottom-Intermediate Shelf	2400x600x850	840

70'lık Seri / 70's Series

Kod Code	Ürün Adı Description	Ebatlar Dimension mm	Fiyatı Price Euro
EMP.PTT.7080	Çalışma Tezgahı Alt Rafı Polietilen Work Table With Bottom-Intermediate Shelf	800x700x850	375
EMP.PTT.70100	Çalışma Tezgahı Alt Rafı Polietilen Work Table With Bottom-Intermediate Shelf	1000x700x850	445
EMP.PTT.70120	Çalışma Tezgahı Alt Rafı Polietilen Work Table With Bottom-Intermediate Shelf	1200x700x850	515
EMP.PTT.70140	Çalışma Tezgahı Alt Rafı Polietilen Work Table With Bottom-Intermediate Shelf	1400x700x850	590
EMP.PTT.70160	Çalışma Tezgahı Alt Rafı Polietilen Work Table With Bottom-Intermediate Shelf	1600x700x850	655
EMP.PTT.70180	Çalışma Tezgahı Alt Rafı Polietilen Work Table With Bottom-Intermediate Shelf	1800x700x850	730
EMP.PTT.70200	Çalışma Tezgahı Alt Rafı Polietilen Work Table With Bottom-Intermediate Shelf	2000x700x850	800
EMP.PTT.70220	Çalışma Tezgahı Alt Rafı Polietilen Work Table With Bottom-Intermediate Shelf	2200x700x850	875
EMP.PTT.70240	Çalışma Tezgahı Alt Rafı Polietilen Work Table With Bottom-Intermediate Shelf	2400x700x850	945

- Tüm ürünler demonte olup, paslanmaz çelikten üretilmektedir.
- Tezgahlar standart olarak sırtlı üretilmektedir.
- Arkası sırtsız tezgahları lütfen bildiriniz.
- Tezgahlar ayarlanabilir ayaklıdır.

- All products are demontable and stainless steel.
- Tables are produced with back standarty.
- Please specify if you don't want back with the table.
- All tables are adjustable feet.



Dolaplı Çalışma Tezgahı (Kaynaklı)
Work Table Cabinet (Welded)

60'lık Seri / 60's Series

Kod Code	Ürün Adı Description	Ebatlar Dimension mm	Fiyatı Price Euro
EMP.DLP.60120	Dolaplı Çalışma Tezgahı Work Table Cabinet	1200x600x850	570
EMP.DLP.60140	Dolaplı Çalışma Tezgahı Work Table Cabinet	1400x600x850	640
EMP.DLP.60160	Dolaplı Çalışma Tezgahı Work Table Cabinet	1600x600x850	720
EMP.DLP.60180	Dolaplı Çalışma Tezgahı Work Table Cabinet	1800x600x850	790
EMP.DLP.60200	Dolaplı Çalışma Tezgahı Work Table Cabinet	2000x600x850	870

70'lık Seri / 70's Series

Kod Code	Ürün Adı Description	Ebatlar Dimension mm	Fiyatı Price Euro
EMP.DLP.70120	Dolaplı Çalışma Tezgahı Work Table Cabinet	1200x700x850	620
EMP.DLP.70140	Dolaplı Çalışma Tezgahı Work Table Cabinet	1400x700x850	700
EMP.DLP.70160	Dolaplı Çalışma Tezgahı Work Table Cabinet	1600x700x850	780
EMP.DLP.70180	Dolaplı Çalışma Tezgahı Work Table Cabinet	1800x700x850	860
EMP.DLP.70200	Dolaplı Çalışma Tezgahı Work Table Cabinet	2000x700x850	935

- Paslanmaz çelikten üretilmektedir.
- Tezgahlar standart olarak sırtlı üretilmektedir.
- Arkası sırtsız tezgahları lütfen bildiriniz.
- Tezgahlar ayarlanabilir ayaklıdır.

- Stainless steel.
- Tables are produced with back standarty.
- Please specify if you don't want back with the table.
- All tables are adjustable feet.

Dolaplı Çalışma Tezgahı Ara Rafı (Kaynaklı)
Work Table Cabinet - Intermediate Shelf (Welded)



60'lık Seri / 60's Series

Kod Code	Ürün Adı Description	Ebatlar Dimension mm	Fiyatı Price Euro
EMP.DLPA.60120	Dolaplı Çalışma Tezgahı Ara Rafı Work Table Cabinet - Intermediate Shelf	1200x600x850	625
EMP.DLPA.60140	Dolaplı Çalışma Tezgahı Ara Rafı Work Table Cabinet - Intermediate Shelf	1400x600x850	700
EMP.DLPA.60160	Dolaplı Çalışma Tezgahı Ara Rafı Work Table Cabinet - Intermediate Shelf	1600x600x850	790
EMP.DLPA.60180	Dolaplı Çalışma Tezgahı Ara Rafı Work Table Cabinet - Intermediate Shelf	1800x600x850	870
EMP.DLPA.60200	Dolaplı Çalışma Tezgahı Ara Rafı Work Table Cabinet - Intermediate Shelf	2000x600x850	945

70'lık Seri / 70's Series

Kod Code	Ürün Adı Description	Ebatlar Dimension mm	Fiyatı Price Euro
EMP.DLPA.70120	Dolaplı Çalışma Tezgahı Ara Rafı Work Table Cabinet - Intermediate Shelf	1200x700x850	685
EMP.DLPA.70140	Dolaplı Çalışma Tezgahı Ara Rafı Work Table Cabinet - Intermediate Shelf	1400x700x850	775
EMP.DLPA.70160	Dolaplı Çalışma Tezgahı Ara Rafı Work Table Cabinet - Intermediate Shelf	1600x700x850	860
EMP.DLPA.70180	Dolaplı Çalışma Tezgahı Ara Rafı Work Table Cabinet - Intermediate Shelf	1800x700x850	940
EMP.DLPA.70200	Dolaplı Çalışma Tezgahı Ara Rafı Work Table Cabinet - Intermediate Shelf	2000x700x850	1.030

- Paslanmaz çelikten üretilmektedir.
- Tezgahlar standart olarak sırtlı üretilmektedir.
- Arkası sırsız tezgahları lütfen bildiriniz.
- Tezgahlar ayarlanabilir ayaklıdır.

- Stainless steel.
- Tables are produced with back standarty.
- Please specify if you don't want back with the table.
- All tables are adjustable feet.

Blok Çekmece Ünitesi
Drawers Unit

Kod Code	Ürün Adı Description	Ebatlar Dimension mm	Fiyatı Price Euro
EMP.BLK.506085	Blok Çekmece Ünitesi Drawers Unit	500x600x850	845
EMP.BLK.507085	Blok Çekmece Ünitesi Drawers Unit	500x700x850	875

- Çekmeceler paslanmaz çelikten üretilmektedir.
- Çekmece ünitesi standart olarak sırtlı üretilmektedir.
- Arkası sırtsız tezgahları lütfen bildiriniz.
- Tezgahlar ayarlanabilir ayaklıdır.

- Stainless steel.
- Drawers are produced with back standarty.
- Please specify if you don't want back with the table.
- All tables are adjustable feet.



Evyeli Tezgahlar Sink With

- 1 Evyeli Tezgahlar 600 / 700 (Demonte) / Work Table With 1 Sink 600 / 700 (Demontable) *
- 1 Evyeli Tezgahlar 600 (Demonte) / Work Table With 1 Sink 600 (Demontable) *
- 1 Evyeli Tezgahlar 700 (Demonte) / Work Table With 1 Sink 700 (Demontable) *
- 1 Evyeli Tezgahlar 600 (Demonte) / Work Table With 1 Sink 600 (Demontable) *
- 1 Evyeli Tezgahlar 700 (Demonte) / Work Table With 1 Sink 700 (Demontable) *
- 2 Evyeli Tezgahlar 600 (Demonte) / Work Table With 2 Sink 600 (Demontable) *
- 2 Evyeli Tezgahlar 700 (Demonte) / Work Table With 2 Sink 700 (Demontable) *
- 2 Evyeli Tezgahlar 600 (Demonte) / Work Table With 2 Sink 600 (Demontable) *
- 2 Evyeli Tezgahlar 700 (Demonte) / Work Table With 2 Sink 700 (Demontable) *
- 3 Evyeli Tezgahlar 600 - 700 (Demonte) / Work Table With 3 Sink 600 - 700 (Demontable) *
- Duvar Dolabı (Sürgü Kapaklı) / Wall Cabinet (Sliding Doors) *
- Duvar Rafı Ayarlanabilir (Demonte) / Wall Shelf Adjustable (Demontable) *
- Duvar Rafı Perfore Ayarlanabilir (Demonte) / Wall Shelf Perforated Adjustable (Demontable) *

1 Evyeli Tezgahlar 600 / 700 (Demonte)
Work Table With 1 Sink 600 / 700 (Demontable)

Kod Code	Ürün Adı Description	Ebatlar Dimension mm	Evyeye Sink mm	Fiyatı Price Euro
EMP.E.66085-1E	Tek Evyeli Tezgah Sink With 1 Bowl	600x600x850	500x400x250	310
EMP.E.76085-1E	Tek Evyeli Tezgah Sink With 1 Bowl	700x600x850	500x400x250	345
EMP.E.67085-1E	Tek Evyeli Tezgah Sink With 1 Bowl	600x700x850	400x500x300	340
EMP.E.77085-1E	Tek Evyeli Tezgah Sink With 1 Bowl	700x700x850	500x500x300	400



Kod Code	Ürün Adı Description	Ebatlar Dimension mm	Evyeye Sink mm	Fiyatı Price Euro
EMP.E.66085-1ET	Tek Evyeli Tezgah Sink With 1 Bowl	600x600x850	500x400x250	340
EMP.E.76085-1ET	Tek Evyeli Tezgah Sink With 1 Bowl	700x600x850	500x400x250	380
EMP.E.67085-1ET	Tek Evyeli Tezgah Sink With 1 Bowl	600x700x850	400x500x300	380
EMP.E.77085-1ET	Tek Evyeli Tezgah Sink With 1 Bowl	700x700x850	500x500x300	450

- Tüm ürünler demonte olup, paslanmaz çelikten üretilmektedir.
- Tezgahlar standart olarak sırtlı üretilmektedir.
- Arkası sırtsız tezgahları lütfen bildiriniz.
- Tezgahlar ayarlanabilir ayaklıdır.

- All products are demontable and stainless steel.
- Tables are produced with back standarty.
- Please specify if you don't want back with the table.
- All tables are adjustable feet.

1 Evyeli Tezgahlar 600 (Demonte)
Work Table With 1 Sink 600 (Demontable)



Kod Code	Ürün Adı Description	Ebatlar Dimension mm	Evyeye Sink mm	Fiyatı Price Euro
EMPE.61085-1E-R	Tek Evyeli Tezgah Sağ Sink With 1 Bowl Right	1000x600x850	500x400x250	395
EMPE.61085-1E-L	Tek Evyeli Tezgah Sol Sink With 1 Bowl Left	1000x600x850	500x400x250	395
EMPE.61285-1E-R	Tek Evyeli Tezgah Sağ Sink With 1 Bowl Right	1200x600x850	500x400x250	430
EMPE.61285-1E-L	Tek Evyeli Tezgah Sol Sink With 1 Bowl Left	1200x600x850	500x400x250	430
EMPE.61485-1E-R	Tek Evyeli Tezgah Sağ Sink With 1 Bowl Right	1400x600x850	500x400x250	475
EMPE.61485-1E-L	Tek Evyeli Tezgah Sol Sink With 1 Bowl Left	1400x600x850	500x400x250	475
EMPE.61685-1E-R	Tek Evyeli Tezgah Sağ Sink With 1 Bowl Right	1600x600x850	500x400x250	520
EMPE.61685-1E-L	Tek Evyeli Tezgah Sol Sink With 1 Bowl Left	1600x600x850	500x400x250	520

- Tüm ürünler demonte olup, paslanmaz çelikten üretilmektedir.
- Tezgahlar standart olarak sırtlı üretilmektedir.
- Arkası sırtsız tezgahları lütfen bildiriniz.
- Tezgahlar ayarlanabilir ayaklıdır.

- All products are demontable and stainless steel.
- Tables are produced with back standarty.
- Please specify if you don't want back with the table.
- All tables are adjustable feet.

1 Evyeli Tezgahlar 700 (Demonte)
Work Table With 1 Sink 700 (Demontable)

Kod Code	Ürün Adı Description	Ebatlar Dimension mm	Eyve Sink mm	Fiyatı Price Euro
EMP.E.71085-1E-R	Tek Evyeli Tezgah Sağ Sink With 1 Bowl Right	1000x700x850	500x500x300	460
EMP.E.71085-1E-L	Tek Evyeli Tezgah Sol Sink With 1 Bowl Left	1000x700x850	500x500x300	460
EMP.E.71285-1E-R	Tek Evyeli Tezgah Sağ Sink With 1 Bowl Right	1200x700x850	500x500x300	500
EMP.E.71285-1E-L	Tek Evyeli Tezgah Sol Sink With 1 Bowl Left	1200x700x850	500x500x300	500
EMP.E.71485-1E-R	Tek Evyeli Tezgah Sağ Sink With 1 Bowl Right	1400x700x850	500x500x300	540
EMP.E.71485-1E-L	Tek Evyeli Tezgah Sol Sink With 1 Bowl Left	1400x700x850	500x500x300	540
EMP.E.71685-1E-R	Tek Evyeli Tezgah Sağ Sink With 1 Bowl Right	1600x700x850	500x500x300	590
EMP.E.71685-1E-L	Tek Evyeli Tezgah Sol Sink With 1 Bowl Left	1600x700x850	500x500x300	590



Kod Code	Ürün Adı Description	Ebatlar Dimension mm	Eyve Sink mm	Fiyatı Price Euro
EMP.E.71485-1EM-R	Tek Evyeli Tezgah Sağ Sink With 1 Bowl Right	1400x700x850	500x500x300	500
EMP.E.71485-1EM-L	Tek Evyeli Tezgah Sol Sink With 1 Bowl Left	1400x700x850	500x500x300	500
EMP.E.71685-1EM-R	Tek Evyeli Tezgah Sağ Sink With 1 Bowl Right	1600x700x850	500x500x300	560
EMP.E.71685-1EM-L	Tek Evyeli Tezgah Sol Sink With 1 Bowl Left	1600x700x850	500x500x300	560
EMP.E.71885-1EM-R	Tek Evyeli Tezgah Sağ Sink With 1 Bowl Right	1800x700x850	500x500x300	600
EMP.E.71885-1EM-L	Tek Evyeli Tezgah Sol Sink With 1 Bowl Left	1800x700x850	500x500x300	600
EMP.E.72085-1EM-R	Tek Evyeli Tezgah Sağ Sink With 1 Bowl Right	2000x700x850	500x500x300	645
EMP.E.72085-1EM-L	Tek Evyeli Tezgah Sol Sink With 1 Bowl Left	2000x700x850	500x500x300	645

- Tüm ürünler demonte olup, paslanmaz çelikten üretilmektedir.
- Tezgahlar standart olarak sırtlı üretilmektedir.
- Arkası sırtsız tezgahları lütfen bildiriniz.
- Tezgahlar ayarlanabilir ayaklıdır.

- All products are demontable and stainless steel.
- Tables are produced with back standarty.
- Please specify if you don't want back with the table.
- All tables are adjustable feet.

1 Evyeli Tezgahlar 600 (Demonte)
Work Table With 1 Sink 600 (Demontable)



Kod Code	Ürün Adı Description	Ebatlar Dimension mm	Evyeye Sink mm	Fiyatı Price Euro
EMP.E.61085-1ET-R	Tek Evyeli Tezgah Sağ Sink With 1 Bowl Right	1000x600x850	500x400x250	430
EMP.E.61085-1ET-L	Tek Evyeli Tezgah Sol Sink With 1 Bowl Left	1000x600x850	500x400x250	430
EMP.E.61285-1ET-R	Tek Evyeli Tezgah Sağ Sink With 1 Bowl Right	1200x600x850	500x400x250	485
EMP.E.61285-1ET-L	Tek Evyeli Tezgah Sol Sink With 1 Bowl Left	1200x600x850	500x400x250	485
EMP.E.61485-1ET-R	Tek Evyeli Tezgah Sağ Sink With 1 Bowl Right	1400x600x850	500x400x250	540
EMP.E.61485-1ET-L	Tek Evyeli Tezgah Sol Sink With 1 Bowl Left	1400x600x850	500x400x250	540
EMP.E.61685-1ET-R	Tek Evyeli Tezgah Sağ Sink With 1 Bowl Right	1600x600x850	500x400x250	600
EMP.E.61685-1ET-L	Tek Evyeli Tezgah Sol Sink With 1 Bowl Left	1600x600x850	500x400x250	600

- Tüm ürünler demonte olup, paslanmaz çelikten üretilmektedir.
- Tezgahlar standart olarak sırtlı üretilmektedir.
- Arkası sırsız tezgahları lütfen bildiriniz.
- Tezgahlar ayarlanabilir ayaklıdır.

- All products are demontable and stainless steel.
- Tables are produced with back standarty.
- Please specify if you don't want back with the table.
- All tables are adjustable feet.

1 Evyeli Tezgahlar 700 (Demonte)
Work Table With 1 Sink 700 (Demontable)

Kod Code	Ürün Adı Description	Ebatlar Dimension mm	Evyeye Sink mm	Fiyatı Price Euro
EMP.E.71085-1ET-R	Tek Evyeli Tezgah Sağ Sink With 1 Bowl Right	1000x700x850	500x500x300	520
EMP.E.71085-1ET-L	Tek Evyeli Tezgah Sol Sink With 1 Bowl Left	1000x700x850	500x500x300	520
EMP.E.71285-1ET-R	Tek Evyeli Tezgah Sağ Sink With 1 Bowl Right	1200x700x850	500x500x300	570
EMP.E.71285-1ET-L	Tek Evyeli Tezgah Sol Sink With 1 Bowl Left	1200x700x850	500x500x300	570
EMP.E.71485-1ET-R	Tek Evyeli Tezgah Sağ Sink With 1 Bowl Right	1400x700x850	500x500x300	600
EMP.E.71485-1ET-L	Tek Evyeli Tezgah Sol Sink With 1 Bowl Left	1400x700x850	500x500x300	600
EMP.E.71685-1ET-R	Tek Evyeli Tezgah Sağ Sink With 1 Bowl Right	1600x700x850	500x500x300	675
EMP.E.71685-1ET-L	Tek Evyeli Tezgah Sol Sink With 1 Bowl Left	1600x700x850	500x500x300	675



Kod Code	Ürün Adı Description	Ebatlar Dimension mm	Evyeye Sink mm	Fiyatı Price Euro
EMP.E.71485-1EMT-R	Tek Evyeli Tezgah Sağ Sink With 1 Bowl Right	1400x700x850	500x500x300	540
EMP.E.71485-1EMT-L	Tek Evyeli Tezgah Sol Sink With 1 Bowl Left	1400x700x850	500x500x300	540
EMP.E.71685-1EMT-R	Tek Evyeli Tezgah Sağ Sink With 1 Bowl Right	1600x700x850	500x500x300	600
EMP.E.71685-1EMT-L	Tek Evyeli Tezgah Sol Sink With 1 Bowl Left	1600x700x850	500x500x300	600
EMP.E.71885-1EMT-R	Tek Evyeli Tezgah Sağ Sink With 1 Bowl Right	1800x700x850	500x500x300	640
EMP.E.71885-1EMT-L	Tek Evyeli Tezgah Sol Sink With 1 Bowl Left	1800x700x850	500x500x300	640
EMP.E.72085-1EMT-R	Tek Evyeli Tezgah Sağ Sink With 1 Bowl Right	2000x700x850	500x500x300	700
EMP.E.72085-1EMT-L	Tek Evyeli Tezgah Sol Sink With 1 Bowl Left	2000x700x850	500x500x300	700

- Tüm ürünler demonte olup, paslanmaz çelikten üretilmektedir.
- Tezgahlar standart olarak sırtlı üretilmektedir.
- Arkası sırtsız tezgahları lütfen bildiriniz.
- Tezgahlar ayarlanabilir ayaklıdır.

- All products are demontable and stainless steel.
- Tables are produced with back standarty.
- Please specify if you don't want back with the table.
- All tables are adjustable feet.

2 Evyeli Tezgahlar 600 (Demonte)
Work Table With 2 Sink 600 (Demontable)



Kod Code	Ürün Adı Description	Ebatlar Dimension mm	Evyel Sink mm	Fiyatı Price Euro
EMPE.61485-2E-R	2 Evyeli Tezgah Sağ Sink With 2 Bowl Right	1400x600x850	500x400x250	570
EMPE.61485-2E-L	2 Evyeli Tezgah Sol Sink With 2 Bowl Left	1400x600x850	500x400x250	570
EMPE.61685-2E-R	2 Evyeli Tezgah Sağ Sink With 2 Bowl Right	1600x600x850	500x400x250	600
EMPE.61685-2E-L	2 Evyeli Tezgah Sol Sink With 2 Bowl Left	1600x600x850	500x400x250	600
EMPE.61885-2E-R	2 Evyeli Tezgah Sağ Sink With 2 Bowl Right	1800x600x850	500x400x250	650
EMPE.61885-2E-L	2 Evyeli Tezgah Sol Sink With 2 Bowl Left	1800x600x850	500x400x250	650
EMPE.62085-2E-R	2 Evyeli Tezgah Sağ Sink With 2 Bowl Right	2000x600x850	500x400x250	690
EMPE.62085-2E-L	2 Evyeli Tezgah Sol Sink With 2 Bowl Left	2000x600x850	500x400x250	690

- Tüm ürünler demonte olup, paslanmaz çelikten üretilmektedir.
- Tezgahlar standart olarak sırtlı üretilmektedir.
- Arkası sırtsız tezgahları lütfen bildiriniz.
- Tezgahlar ayarlanabilir ayaklıdır.

- All products are demontable and stainless steel.
- Tables are produced with back standartly.
- Please specify if you don't want back with the table.
- All tables are adjustable feet.

2 Evyeli Tezgahlar 700 (Demonte)
Work Table With 2 Sink 700 (Demontable)

Kod Code	Ürün Adı Description	Ebatlar Dimension mm	Evyeye Sink mm	Fiyatı Price Euro
EMP.E.71485-2E-R	2 Evyeli Tezgah Sağ Sink With 2 Bowl Right	1400x700x850	400x500x250	625
EMP.E.71485-2E-L	2 Evyeli Tezgah Sol Sink With 2 Bowl Left	1400x700x850	400x500x250	625
EMP.E.71685-2E-R	2 Evyeli Tezgah Sağ Sink With 2 Bowl Right	1600x700x850	500x500x300	720
EMP.E.71685-2E-L	2 Evyeli Tezgah Sol Sink With 2 Bowl Left	1600x700x850	500x500x300	720
EMP.E.71885-2E-R	2 Evyeli Tezgah Sağ Sink With 2 Bowl Right	1800x700x850	500x500x300	760
EMP.E.71885-2E-L	2 Evyeli Tezgah Sol Sink With 2 Bowl Left	1800x700x850	500x500x300	760
EMP.E.72085-2E-R	2 Evyeli Tezgah Sağ Sink With 2 Bowl Right	2000x700x850	500x500x300	820
EMP.E.72085-2E-L	2 Evyeli Tezgah Sol Sink With 2 Bowl Left	2000x700x850	500x500x300	820



Kod Code	Ürün Adı Description	Ebatlar Dimension mm	Evyeye Sink mm	Fiyatı Price Euro
EMP.E.71685-2EM-R	2 Evyeli Tezgah Sağ Sink With 2 Bowl Right	1600x700x850	400x500x250	580
EMP.E.71685-2EM-L	2 Evyeli Tezgah Sol Sink With 2 Bowl Left	1600x700x850	400x500x250	580
EMP.E.71885-2EM-R	2 Evyeli Tezgah Sağ Sink With 2 Bowl Right	1800x700x850	500x500x300	600
EMP.E.71885-2EM-L	2 Evyeli Tezgah Sol Sink With 2 Bowl Left	1800x700x850	500x500x300	600
EMP.E.72085-2EM-R	2 Evyeli Tezgah Sağ Sink With 2 Bowl Right	2000x700x850	500x500x300	650
EMP.E.72085-2EM-L	2 Evyeli Tezgah Sol Sink With 2 Bowl Left	2000x700x850	500x500x300	650

- Tüm ürünler demonte olup, paslanmaz çelikten üretilmektedir.
- Tezgahlar standart olarak sırtlı üretilmektedir.
- Arkası sırtsız tezgahları lütfen bildiriniz.
- Tezgahlar ayarlanabilir ayaklıdır.

- All products are demontable and stainless steel.
- Tables are produced with back standarty.
- Please specify if you don't want back with the table.
- All tables are adjustable feet.

2 Evyeli Tezgahlar 600 (Demonte)
Work Table With 2 Sink 600 (Demontable)



Kod Code	Ürün Adı Description	Ebatlar Dimension mm	Evyeli Sink mm	Fiyatı Price Euro
EMP.E.61485-2ET-R	2 Evyeli Tezgah Sağ Sink With 2 Bowl Right	1400x600x850	400x400x250	630
EMP.E.61485-2ET-L	2 Evyeli Tezgah Sol Sink With 2 Bowl Left	1400x600x850	400x400x250	630
EMP.E.61685-2ET-R	2 Evyeli Tezgah Sağ Sink With 2 Bowl Right	1600x600x850	400x400x250	680
EMP.E.61685-2ET-L	2 Evyeli Tezgah Sol Sink With 2 Bowl Left	1600x600x850	400x400x250	680
EMP.E.61885-2ET-R	2 Evyeli Tezgah Sağ Sink With 2 Bowl Right	1800x600x850	500x400x250	735
EMP.E.61885-2ET-L	2 Evyeli Tezgah Sol Sink With 2 Bowl Left	1800x600x850	500x400x250	735
EMP.E.62085-2ET-R	2 Evyeli Tezgah Sağ Sink With 2 Bowl Right	2000x600x850	500x400x250	790
EMP.E.62085-2ET-L	2 Evyeli Tezgah Sol Sink With 2 Bowl Left	2000x600x850	500x400x250	790

- Tüm ürünler demonte olup, paslanmaz çelikten üretilmektedir.
- Tezgahlar standart olarak sırtlı üretilmektedir.
- Arkası sırtsız tezgahları lütfen bildiriniz.
- Tezgahlar ayarlanabilir ayaklıdır.

- All products are demontable and stainless steel.
- Tables are produced with back standarty.
- Please specify if you don't want back with the table.
- All tables are adjustable feet.

2 Evyeli Tezgahlar 700 (Demonte)
Work Table With 2 Sink 700 (Demontable)

Kod Code	Ürün Adı Description	Ebatlar Dimension mm	Evyeye Sink mm	Fiyatı Price Euro
EMP.E.71485-2ET-R	2 Evyeli Tezgah Sağ Sink With 2 Bowl Right	1400x700x850	400x500x250	690
EMP.E.71485-2ET-L	2 Evyeli Tezgah Sol Sink With 2 Bowl Left	1400x700x850	400x500x250	690
EMP.E.71685-2ET-R	2 Evyeli Tezgah Sağ Sink With 2 Bowl Right	1600x700x850	500x500x300	800
EMP.E.71685-2ET-L	2 Evyeli Tezgah Sol Sink With 2 Bowl Left	1600x700x850	500x500x300	800
EMP.E.71885-2ET-R	2 Evyeli Tezgah Sağ Sink With 2 Bowl Right	1800x700x850	500x500x300	850
EMP.E.71885-2ET-L	2 Evyeli Tezgah Sol Sink With 2 Bowl Left	1800x700x850	500x500x300	850
EMP.E.72085-2ET-R	2 Evyeli Tezgah Sağ Sink With 2 Bowl Right	2000x700x850	500x500x300	925
EMP.E.72085-2ET-L	2 Evyeli Tezgah Sol Sink With 2 Bowl Left	2000x700x850	500x500x300	925



Kod Code	Ürün Adı Description	Ebatlar Dimension mm	Evyeye Sink mm	Fiyatı Price Euro
EMP.E.71685-2EMT-R	2 Evyeli Tezgah Sağ Sink With 2 Bowl Right	1600x700x850	400x500x250	620
EMP.E.71685-2EMT-L	2 Evyeli Tezgah Sol Sink With 2 Bowl Left	1600x700x850	400x500x250	620
EMP.E.71885-2EMT-R	2 Evyeli Tezgah Sağ Sink With 2 Bowl Right	1800x700x850	500x500x300	670
EMP.E.71885-2EMT-L	2 Evyeli Tezgah Sol Sink With 2 Bowl Left	1800x700x850	500x500x300	670
EMP.E.72085-2EMT-R	2 Evyeli Tezgah Sağ Sink With 2 Bowl Right	2000x700x850	500x500x300	730
EMP.E.72085-2EMT-L	2 Evyeli Tezgah Sol Sink With 2 Bowl Left	2000x700x850	500x500x300	730

- Tüm ürünler demonte olup, paslanmaz çelikten üretilmektedir.
- Tezgahlar standart olarak sırtlı üretilmektedir.
- Arkası sırtsız tezgahları lütfen bildiriniz.
- Tezgahlar ayarlanabilir ayaklıdır.

- All products are demontable and stainless steel.
- Tables are produced with back standarty.
- Please specify if you don't want back with the table.
- All tables are adjustable feet.

3 Evyeli Tezgahlar 600 - 700 (Demonte)
Work Table With 3 Sink 600 - 700 (Demontable)



3 Evyeli Tezgah / Sink With 3 Bowl

Kod Code	Ürün Adı Description	Ebatlar Dimension mm	Evyeye Sink mm	Fiyatı Price Euro
EMP.E.61885-3E	3 Evyeli Tezgah Sink With 3 Bowl	1800x600x850	400x500x250	750
EMP.E.71885-3E	3 Evyeli Tezgah Sink With 3 Bowl	1800x700x850	500x500x300	880
EMP.E.72085-3E	3 Evyeli Tezgah Sink With 3 Bowl	2000x700x850	500x500x300	925



3 Evyeli Alt Rafı Tezgah / Sink With 3 Bowled Bottom Shelf

Kod Code	Ürün Adı Description	Ebatlar Dimension mm	Evyeye Sink mm	Fiyatı Price Euro
EMP.E.61885-3ET	3 Evyeli Tezgah Sink With 3 Bowl	1800x600x850	400x500x250	835
EMP.E.71885-3ET	3 Evyeli Tezgah Sink With 3 Bowl	1800x700x850	500x500x300	975
EMP.E.72085-3ET	3 Evyeli Tezgah Sink With 3 Bowl	2000x700x850	500x500x300	1.030



Sebze Yıkama Tezgahı / Vegetable Washing Unit

Kod Code	Ürün Adı Description	Ebatlar Dimension mm	Fiyatı Price Euro
EMP.SY.71285	Sebze Yıkama Tezgahı Vegetable Washing Unit	1200x700x850	685
EMP.SY.71485	Sebze Yıkama Tezgahı Vegetable Washing Unit	1400x700x850	775



Duvar Dolabı (Sürgü Kapaklı)
Wall Cabinet (Sliding Doors)

30'luk Seri / 30's Series

Kod Code	Ebatlar Dimension mm	Fiyatı Price Euro
EMP.DDS.3120	1200x300x600	347
EMP.DDS.3140	1400x300x600	387
EMP.DDS.3160	1600x300x600	432
EMP.DDS.3180	1800x300x600	468
EMP.DDS.3200	2000x300x600	513

40'luk Seri / 40's Series

Kod Code	Ebatlar Dimension mm	Fiyatı Price Euro
EMP.DDS.4120	1200x400x600	374
EMP.DDS.4140	1400x400x600	428
EMP.DDS.4160	1600x400x600	468
EMP.DDS.4180	1800x400x600	522
EMP.DDS.4200	2000x400x600	563

Duvar Rafı Ayarlanabilir (Demonte)

Wall Shelf Adjustable (Demontable)



30'luk Seri / 30's Series

Kod Code	Ebatlar Dimension mm	Fiyatı Price Euro
EMP.ET1.3080	800x300	55
EMP.ET1.30100	1000x300	64
EMP.ET1.30120	1200x300	72
EMP.ET1.30140	1400x300	81
EMP.ET1.30160	1600x300	85
EMP.ET1.30180	1800x300	94
EMP.ET1.30200	2000x300	98

40'luk Seri / 40's Series

Kod Code	Ebatlar Dimension mm	Fiyatı Price Euro
EMP.ET1.4080	800x400	64
EMP.ET1.40100	1000x400	77
EMP.ET1.40120	1200x400	85
EMP.ET1.40140	1400x400	94
EMP.ET1.40160	1600x400	102
EMP.ET1.40180	1800x400	119
EMP.ET1.40200	2000x400	128

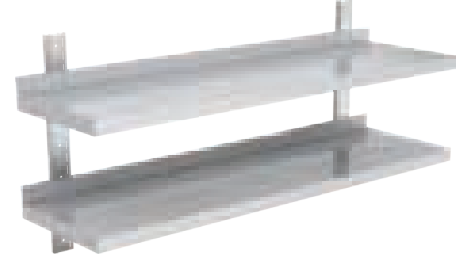

30'luk Seri / 30's Series

Kod Code	Ebatlar Dimension mm	Fiyatı Price Euro
EMP.ET2.3080	800x300	106
EMP.ET2.30100	1000x300	128
EMP.ET2.30120	1200x300	136
EMP.ET2.30140	1400x300	153
EMP.ET2.30160	1600x300	170
EMP.ET2.30180	1800x300	183
EMP.ET2.30200	2000x300	196

40'luk Seri / 40's Series

Kod Code	Ebatlar Dimension mm	Fiyatı Price Euro
EMP.ET2.4080	800x400	128
EMP.ET2.40100	1000x400	149
EMP.ET2.40120	1200x400	162
EMP.ET2.40140	1400x400	183
EMP.ET2.40160	1600x400	196
EMP.ET2.40180	1800x400	213
EMP.ET2.40200	2000x400	238



30'luk Seri / 30's Series

Kod Code	Ebatlar Dimension mm	Fiyatı Price Euro
EMP.ET3.3080	800x300	162
EMP.ET3.30100	1000x300	187
EMP.ET3.30120	1200x300	204
EMP.ET3.30140	1400x300	234
EMP.ET3.30160	1600x300	255
EMP.ET3.30180	1800x300	276
EMP.ET3.30200	2000x300	306

40'luk Seri / 40's Series

Kod Code	Ebatlar Dimension mm	Fiyatı Price Euro
EMP.ET3.4080	800x400	196
EMP.ET3.40100	1000x400	213
EMP.ET3.40120	1200x400	247
EMP.ET3.40140	1400x400	268
EMP.ET3.40160	1600x400	306
EMP.ET3.40180	1800x400	323
EMP.ET3.40200	2000x400	353

Duvar Rafı Perfore Ayarlanabilir (Demonte)
Wall Shelf Perforated Adjustable (Demontable)

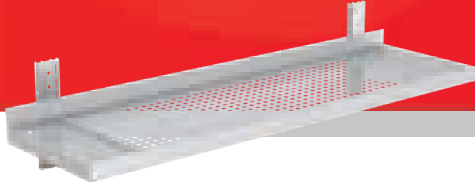

30'luk Seri / 30's Series

Kod Code	Ebatlar Dimension mm	Fiyatı Price Euro
EMP.ETP1.3080	800x300	64
EMP.ETP1.30100	1000x300	77
EMP.ETP1.30120	1200x300	85
EMP.ETP1.30140	1400x300	94
EMP.ETP1.30160	1600x300	98
EMP.ETP1.30180	1800x300	106
EMP.ETP1.30200	2000x300	111

40'luk Seri / 40's Series

Kod Code	Ebatlar Dimension mm	Fiyatı Price Euro
EMP.ETP1.4080	800x400	77
EMP.ETP1.40100	1000x400	85
EMP.ETP1.40120	1200x400	94
EMP.ETP1.40140	1400x400	106
EMP.ETP1.40160	1600x400	119
EMP.ETP1.40180	1800x400	136
EMP.ETP1.40200	2000x400	145

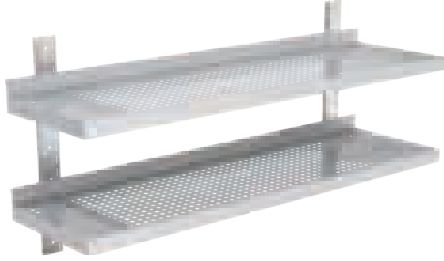

30'luk Seri / 30's Series

Kod Code	Ebatlar Dimension mm	Fiyatı Price Euro
EMP.ETP2.3080	800x300	128
EMP.ETP2.30100	1000x300	145
EMP.ETP2.30120	1200x300	157
EMP.ETP2.30140	1400x300	191
EMP.ETP2.30160	1600x300	208
EMP.ETP2.30180	1800x300	225
EMP.ETP2.30200	2000x300	238

40'luk Seri / 40's Series

Kod Code	Ebatlar Dimension mm	Fiyatı Price Euro
EMP.ETP2.4080	800x400	149
EMP.ETP2.40100	1000x400	170
EMP.ETP2.40120	1200x400	183
EMP.ETP2.40140	1400x400	225
EMP.ETP2.40160	1600x400	238
EMP.ETP2.40180	1800x400	255
EMP.ETP2.40200	2000x400	276



30'luk Seri / 30's Series

Kod Code	Ebatlar Dimension mm	Fiyatı Price Euro
EMP.ETP3.3080	800x300	191
EMP.ETP3.30100	1000x300	221
EMP.ETP3.30120	1200x300	238
EMP.ETP3.30140	1400x300	281
EMP.ETP3.30160	1600x300	298
EMP.ETP3.30180	1800x300	323
EMP.ETP3.30200	2000x300	353

40'luk Seri / 40's Series

Kod Code	Ebatlar Dimension mm	Fiyatı Price Euro
EMP.ETP3.4080	800x400	230
EMP.ETP3.40100	1000x400	247
EMP.ETP3.40120	1200x400	276
EMP.ETP3.40140	1400x400	323
EMP.ETP3.40160	1600x400	353
EMP.ETP3.40180	1800x400	374
EMP.ETP3.40200	2000x400	404



Davlumbazlar Hoods

- Davlumbaz Duvar Tip Filtreli / Wall Type hood with Filters ***
- Kutu Davlumbaz Duvar Tip Filtreli / Wall Type Box Hood With Filters ***
- Davlumbaz Orta Tip Filtreli / Central Type Hood With Filters ***
- Davlumbaz Orta Tip Filtreli / Central Type hood with Filters ***
- Davlumbaz Orta Tip Filtreli / Central Type hood with Filters ***

Davlumbaz Duvar Tip Filtreli
Wall Type hood with Filters

400 Seri / 400 Series

Kod Code	Ebatlar Dimension mm	Filtre Filters	Fiyatı Price Euro
EMP.DDVLK.1074	1000x700x400	1 Filtre / Filters	317
EMP.DDVLK.1574	1500x700x400	2 Filtre / Filters	431
EMP.DDVLK.2074	2000x700x400	3 Filtre / Filters	545
EMP.DDVLK.2574	2500x700x400	4 Filtre / Filters	659
EMP.DDVLK.3074	3000x700x400	5 Filtre / Filters	772
EMP.DDVLK.3574	3500x700x400	6 Filtre / Filters	970
EMP.DDVLK.4074	4000x700x400	6 Filtre / Filters	1.079
EMP.DDVLK.4574	4500x700x400	7 Filtre / Filters	1.198
EMP.DDVLK.5074	5000x700x400	8 Filtre / Filters	1.307

500 Seri / 500 Series

Kod Code	Ebatlar Dimension mm	Filtre Filters	Fiyatı Price Euro
EMP.DDVLK.1075	1000x700x500	1 Filtre / Filters	342
EMP.DDVLK.1575	1500x700x500	2 Filtre / Filters	465
EMP.DDVLK.2075	2000x700x500	3 Filtre / Filters	584
EMP.DDVLK.2575	2500x700x500	4 Filtre / Filters	703
EMP.DDVLK.3075	3000x700x500	5 Filtre / Filters	827
EMP.DDVLK.3575	3500x700x500	6 Filtre / Filters	1.040
EMP.DDVLK.4075	4000x700x500	6 Filtre / Filters	1.158
EMP.DDVLK.4575	4500x700x500	7 Filtre / Filters	1.283
EMP.DDVLK.5075	5000x700x500	8 Filtre / Filters	1.401

Kod Code	Ebatlar Dimension mm	Filtre Filters	Fiyatı Price Euro
EMP.DDVLK.1094	1000x900x400	1 Filtre / Filters	347
EMP.DDVLK.1594	1500x900x400	2 Filtre / Filters	465
EMP.DDVLK.2094	2000x900x400	3 Filtre / Filters	584
EMP.DDVLK.2594	2500x900x400	4 Filtre / Filters	708
EMP.DDVLK.3094	3000x900x400	5 Filtre / Filters	827
EMP.DDVLK.3594	3500x900x400	6 Filtre / Filters	1.045
EMP.DDVLK.4094	4000x900x400	6 Filtre / Filters	1.164
EMP.DDVLK.4594	4500x900x400	7 Filtre / Filters	1.283
EMP.DDVLK.5094	5000x900x400	8 Filtre / Filters	1.401

Kod Code	Ebatlar Dimension mm	Filtre Filters	Fiyatı Price Euro
EMP.DDVLK.1095	1000x900x500	1 Filtre / Filters	372
EMP.DDVLK.1595	1500x900x500	2 Filtre / Filters	500
EMP.DDVLK.2095	2000x900x500	3 Filtre / Filters	629
EMP.DDVLK.2595	2500x900x500	4 Filtre / Filters	758
EMP.DDVLK.3095	3000x900x500	5 Filtre / Filters	887
EMP.DDVLK.3595	3500x900x500	6 Filtre / Filters	1.119
EMP.DDVLK.4095	4000x900x500	6 Filtre / Filters	1.247
EMP.DDVLK.4595	4500x900x500	7 Filtre / Filters	1.386
EMP.DDVLK.5095	5000x900x500	8 Filtre / Filters	1.505

Kod Code	Ebatlar Dimension mm	Filtre Filters	Fiyatı Price Euro
EMP.DDVLK.10114	1000x1100x400	1 Filtre / Filters	372
EMP.DDVLK.15114	1500x1100x400	2 Filtre / Filters	500
EMP.DDVLK.20114	2000x1100x400	3 Filtre / Filters	629
EMP.DDVLK.25114	2500x1100x400	4 Filtre / Filters	752
EMP.DDVLK.30114	3000x1100x400	5 Filtre / Filters	881
EMP.DDVLK.35114	3500x1100x400	6 Filtre / Filters	1.119
EMP.DDVLK.40114	4000x1100x400	6 Filtre / Filters	1.247
EMP.DDVLK.45114	4500x1100x400	7 Filtre / Filters	1.376
EMP.DDVLK.50114	5000x1100x400	8 Filtre / Filters	1.500

Kod Code	Ebatlar Dimension mm	Filtre Filters	Fiyatı Price Euro
EMP.DDVLK.10115	1000x1100x500	1 Filtre / Filters	401
EMP.DDVLK.15115	1500x1100x500	2 Filtre / Filters	540
EMP.DDVLK.20115	2000x1100x500	3 Filtre / Filters	673
EMP.DDVLK.25115	2500x1100x500	4 Filtre / Filters	807
EMP.DDVLK.30115	3000x1100x500	5 Filtre / Filters	941
EMP.DDVLK.35115	3500x1100x500	6 Filtre / Filters	1.198
EMP.DDVLK.40115	4000x1100x500	6 Filtre / Filters	1.332
EMP.DDVLK.45115	4500x1100x500	7 Filtre / Filters	1.471
EMP.DDVLK.50115	5000x1100x500	8 Filtre / Filters	1.604

450 - 500 cm ölçülü davlumbazlar iki parçadan oluşmaktadır. // 450 - 500 cm hoods are two pieces.

Kutu Davlumbaz Duvar Tip Filtreli
Wall Type Box Hood With Filters



400 Seri / 400 Series

Kod Code	Ebatlar Dimension mm	Filtre Filters	Fiyatı Price Euro
EMP.DDVLD.1094	1000x900x400	1 Filtre / Filters	372
EMP.DDVLD.1594	1500x900x400	2 Filtre / Filters	505
EMP.DDVLD.2094	2000x900x400	3 Filtre / Filters	634
EMP.DDVLD.2594	2500x900x400	4 Filtre / Filters	762
EMP.DDVLD.3094	3000x900x400	5 Filtre / Filters	891
EMP.DDVLD.3594	3500x900x400	6 Filtre / Filters	1.124
EMP.DDVLD.4094	4000x900x400	6 Filtre / Filters	1.257
EMP.DDVLD.4594	4500x900x400	7 Filtre / Filters	1.386
EMP.DDVLD.5094	5000x900x400	8 Filtre / Filters	1.515

Kod Code	Ebatlar Dimension mm	Filtre Filters	Fiyatı Price Euro
EMP.DDVLD.10114	1000x1100x400	1 Filtre / Filters	401
EMP.DDVLD.15114	1500x1100x400	2 Filtre / Filters	540
EMP.DDVLD.20114	2000x1100x400	3 Filtre / Filters	679
EMP.DDVLD.25114	2500x1100x400	4 Filtre / Filters	812
EMP.DDVLD.30114	3000x1100x400	5 Filtre / Filters	950
EMP.DDVLD.35114	3500x1100x400	6 Filtre / Filters	1.208
EMP.DDVLD.40114	4000x1100x400	6 Filtre / Filters	1.346
EMP.DDVLD.45114	4500x1100x400	7 Filtre / Filters	1.481
EMP.DDVLD.50114	5000x1100x400	8 Filtre / Filters	1.619

500 Seri / 500 Series

Kod Code	Ebatlar Dimension mm	Filtre Filters	Fiyatı Price Euro
EMP.DDVLD.1095	1000x900x500	1 Filtre / Filters	401
EMP.DDVLD.1595	1500x900x500	2 Filtre / Filters	540
EMP.DDVLD.2095	2000x900x500	3 Filtre / Filters	679
EMP.DDVLD.2595	2500x900x500	4 Filtre / Filters	817
EMP.DDVLD.3095	3000x900x500	5 Filtre / Filters	950
EMP.DDVLD.3595	3500x900x500	6 Filtre / Filters	1.208
EMP.DDVLD.4095	4000x900x500	6 Filtre / Filters	1.346
EMP.DDVLD.4595	4500x900x500	7 Filtre / Filters	1.485
EMP.DDVLD.5095	5000x900x500	8 Filtre / Filters	1.624

Kod Code	Ebatlar Dimension mm	Filtre Filters	Fiyatı Price Euro
EMP.DDVLD.10115	1000x1100x500	1 Filtre / Filters	436
EMP.DDVLD.15115	1500x1100x500	2 Filtre / Filters	580
EMP.DDVLD.20115	2000x1100x500	3 Filtre / Filters	723
EMP.DDVLD.25115	2500x1100x500	4 Filtre / Filters	871
EMP.DDVLD.30115	3000x1100x500	5 Filtre / Filters	1.015
EMP.DDVLD.35115	3500x1100x500	6 Filtre / Filters	1.292
EMP.DDVLD.40115	4000x1100x500	6 Filtre / Filters	1.441
EMP.DDVLD.45115	4500x1100x500	7 Filtre / Filters	1.584
EMP.DDVLD.50115	5000x1100x500	8 Filtre / Filters	1.728

450 - 500 cm ölçülü davlumbazlar iki parçadan oluşmaktadır. // 450 - 500 cm hoods are two pieces.

Davlumbaz Orta Tip Filtreli
Central Type Hood With Filters

1970x400 Seri / 1970x400 Series

Kod Code	Ebatlar Dimension mm	Filtre Filters	Fiyatı Price Euro
EMP.OVDL.10194-M	1000x1970x400	2 Filtre / Filters	639
EMP.OVDL.15194-M	1500x1970x400	4 Filtre / Filters	871
EMP.OVDL.20194-M	2000x1970x400	6 Filtre / Filters	1.104
EMP.OVDL.25194-M	2500x1970x400	8 Filtre / Filters	1.337
EMP.OVDL.30194-M	3000x1970x400	10 Filtre / Filters	1.564
EMP.OVDL.35194-M	3500x1970x400	12 Filtre / Filters	1.960
EMP.OVDL.40194-M	4000x1970x400	12 Filtre / Filters	2.193
EMP.OVDL.45194-M	4500x1970x400	14 Filtre / Filters	2.421
EMP.OVDL.50194-M	5000x1970x400	16 Filtre / Filters	2.643

2470x400 Seri / 2470x400 Series

Kod Code	Ebatlar Dimension mm	Filtre Filters	Fiyatı Price Euro
EMP.OVDL.10244-M	1000x2470x400	2 Filtre / Filters	713
EMP.OVDL.15244-M	1500x2470x400	4 Filtre / Filters	966
EMP.OVDL.20244-M	2000x2470x400	6 Filtre / Filters	1.218
EMP.OVDL.25244-M	2500x2470x400	8 Filtre / Filters	1.471
EMP.OVDL.30244-M	3000x2470x400	10 Filtre / Filters	1.723
EMP.OVDL.35244-M	3500x2470x400	12 Filtre / Filters	2.168
EMP.OVDL.40244-M	4000x2470x400	12 Filtre / Filters	2.416
EMP.OVDL.45244-M	4500x2470x400	14 Filtre / Filters	2.673
EMP.OVDL.50244-M	5000x2470x400	16 Filtre / Filters	2.921

450 - 500 cm ölçülü davlumbazlar iki parçadan oluşmaktadır. // 450 - 500 cm hoods are two pieces.

Davlumbaz Orta Tip Filtreli
Central Type hood with Filters



1970x500 Seri / 1970x500 Series

Kod Code	Ebatlar Dimension mm	Filtre Filters	Fiyatı Price Euro
EMP.OVDL.10195-M	1000x1970x500	2 Filtre / Filters	683
EMP.OVDL.15195-M	1500x1970x500	4 Filtre / Filters	926
EMP.OVDL.20195-M	2000x1970x500	6 Filtre / Filters	1.168
EMP.OVDL.25195-M	2500x1970x500	8 Filtre / Filters	1.406
EMP.OVDL.30195-M	3000x1970x500	10 Filtre / Filters	1.649
EMP.OVDL.35195-M	3500x1970x500	12 Filtre / Filters	2.079
EMP.OVDL.40195-M	4000x1970x500	12 Filtre / Filters	2.312
EMP.OVDL.45195-M	4500x1970x500	14 Filtre / Filters	2.554
EMP.OVDL.50195-M	5000x1970x500	16 Filtre / Filters	2.797

450 - 500 cm ölçülü davlumbazlar iki parçadan oluşmaktadır. // 450 - 500 cm hoods are two pieces.

Davlumbaz Orta Tip Filtreli
Central Type hood with Filters

2470x500 Seri / 2470x500 Series

Kod Code	Ebatlar Dimension mm	Filtre Filters	Fiyatı Price Euro
EMP.OVDL.10245-M	1000x2470x500	2 Filtre / Filters	762
EMP.OVDL.15245-M	1500x2470x500	4 Filtre / Filters	1.025
EMP.OVDL.20245-M	2000x2470x500	6 Filtre / Filters	1.287
EMP.OVDL.25245-M	2500x2470x500	8 Filtre / Filters	1.544
EMP.OVDL.30245-M	3000x2470x500	10 Filtre / Filters	1.807
EMP.OVDL.35245-M	3500x2470x500	12 Filtre / Filters	2.297
EMP.OVDL.40245-M	4000x2470x500	12 Filtre / Filters	2.550
EMP.OVDL.45245-M	4500x2470x500	14 Filtre / Filters	2.812
EMP.OVDL.50245-M	5000x2470x500	16 Filtre / Filters	3.069

450 - 500 cm ölçülü davlumbazlar iki parçadan oluşmaktadır. // 450 - 500 cm hoods are two pieces.



Gn Küvetler & Evyeler Gn Containers & Sinks

- GN Küvetler - Standart / GN Containers - Standart ***
- GN Küvetler - Standart / GN Containers - Standart ***
- GN Küvetler - Saplı / GN Containers - With Handle ***
- GN Küvetler - Saplı / GN Containers - With Handle ***
- GN Küvetler - Delikli / GN Containers - Perforated ***
- GN Küvetler - Delikli / GN Containers - Perforated ***
- Kapak - Standart / Saplı / Kepçeli Kesim / Lids / Standard / with Handle / with Ladle Cut ***
- Kapak - Slikon Eklemler ve Klipsli / Lids with Silicone Joint / Silicone Joint & Clips ***
- Polikarbonat Gn Küvetler ve Kapaklar / Polycarbonate GN Containers & Lids ***
- Dondurma Küveti / Ice Cream Containers ***
- Bain-Marie Sosluk ve Kapakları / Bain-Marie Sauce Bins & Lids ***
- Endüstriyel Evyeler / Industrial Sinks ***
- Sağ Damlalıklı Çiftli Evye / Double Sink Units with Right-Hand Drip tray ***
- Sol Damlalıklı Çiftli Evye / Double Sink Units with Left-Hand Drip tray ***
- Sağ Damlalıklı Tekli Evye / Single Sink Units with Right-Hand Drip tray ***
- Sol Damlalıklı Tekli Evye / Single Sink Units with Left-Hand Drip tray ***
- Damlaliksiz Evye / Single Sink Units without Drip tray (central sink) ***
- Damlaliksiz Çift Evyeler / Double Sink Units without Drip tray (central sink) ***
- Damlaliksiz Üçlü Evye / Triple Sink Units without Drip tray ***
- Dört Damlalıklı Tepsili Evye / Quad Sink Unit without Drip tray ***
- Çift Damlalıklı Tek ve Çift Evyeler / Single & Double Sink Units with Double Drip tray ***
- Sebze Yıkama Üniteleri / Vegetable Washing Units ***
- Bain - Marie Havuzları / Bain - Marie Wells ***
- Bain - Marie Havuzları (Monoblock) / Bain - Marie Wells (Monoblock) ***
- Bain - Marie Havuzları / Bain - Marie Units with Uppertable ***



GN Küvetler - Standart
GN Containers - Standart



Kod Code	Ürün Adı Description	Ebatlar Dimension mm	Kutu Ebatları Box Dimension mm	Kutu Adedi Qty In box mm	Fiyatı Price Euro
EMP. 2120	GN 2/1-20	650 x 530 x 20	660 x 550 x 120	10	24
EMP. 2140	GN 2/1-40	650 x 530 x 40	660 x 550 x 160	10	25.5
EMP. 2165	GN 2/1-65	650 x 530 x 65	660 x 550 x 180	10	31
EMP. 21100	GN 2/1-100	650 x 530 x 100	660 x 550 x 290	10	35
EMP. 21150	GN 2/1-150	650 x 530 x 150	660 x 550 x 360	10	54
EMP. 21200	GN 2/1-200	650 x 530 x 200	660 x 550 x 360	5	60
EMP. 1120	GN 1/1-20	530 x 325 x 20	540 x 360 x 120	20	11.5
EMP. 1140	GN 1/1-40	530 x 325 x 40	540 x 360 x 240	20	13
EMP. 1165	GN 1/1-65	530 x 325 x 65	540 x 360 x 240	20	14.5
EMP. 11100	GN 1/1-100	530 x 325 x 100	540 x 360 x 355	15	16
EMP. 11150	GN 1/1-150	530 x 325 x 150	540 x 360 x 420	15	22.3
EMP. 11200	GN 1/1-200	530 x 325 x 200	540 x 360 x 420	9	27
EMP. 2420	GN 2/4-20	162 x 530 x 20	540 x 360 x 120	20	10.5
EMP. 2440	GN 2/4-40	162 x 530 x 40	540 x 360 x 120	20	15
EMP. 2465	GN 2/4-65	162 x 530 x 65	540 x 360 x 290	20	17
EMP. 24100	GN 2/4-100	162 x 530 x 100	540 x 360 x 320	20	18.5
EMP. 24150	GN 2/4-150	162 x 530 x 150	540 x 360 x 420	20	25
EMP. 2320	GN 2/3-20	354 x 325 x 20	540 x 360 x 240	15	9
EMP. 2340	GN 2/3-40	354 x 325 x 40	540 x 360 x 240	20	9.25
EMP. 2365	GN 2/3-65	354 x 325 x 65	540 x 360 x 355	15	12.5
EMP. 23100	GN 2/3-100	354 x 325 x 100	540 x 360 x 420	20	14.5
EMP. 23150	GN 2/3-150	354 x 325 x 150	540 x 360 x 420	15	23
EMP. 23200	GN 2/3-200	354 x 325 x 200	540 x 360 x 420	12	30

GN Küvetler - Standart
GN Containers - Standart



Kod Code	Ürün Adı Description	Ebatlar Dimension mm	Kutu Ebatları Box Dimension mm	Kutu Adedi Qty In box mm	Fiyatı Price Euro
EMP.1220	GN 1/2-20	325 x 265 x 20	540 x 360 x 120	20	7.5
EMP.1240	GN 1/2-40	325 x 265 x 40	540 x 360 x 120	20	8.5
EMP.1265	GN 1/2-65	325 x 265 x 65	540 x 360 x 180	20	9.25
EMP.12100	GN 1/2-100	325 x 265 x 100	540 x 360 x 240	15	11.2
EMP.12150	GN 1/2-150	325 x 265 x 150	540 x 360 x 420	20	13.4
EMP.12200	GN 1/2-200	325 x 265 x 200	540 x 360 x 420	8	20
EMP.1320	GN 1/3-20	325 x 176 x 20	540 x 360 x 120	25	6
EMP.1340	GN 1/3-40	325 x 176 x 40	540 x 360 x 120	25	7
EMP.1365	GN 1/3-65	325 x 176 x 65	540 x 360 x 180	20	7.8
EMP.13100	GN 1/3-100	325 x 176 x 100	540 x 360 x 290	25	9.4
EMP.13150	GN 1/3-150	325 x 176 x 150	540 x 360 x 420	20	16
EMP.13200	GN 1/3-200	325 x 176 x 200	540 x 360 x 420	20	21.5
EMP.1420	GN 1/4-20	265 x 162 x 20	540 x 360 x 120	25	5.5
EMP.1440	GN 1/4-40	265 x 162 x 40	540 x 360 x 120	25	6.4
EMP.1465	GN 1/4-65	265 x 162 x 65	540 x 360 x 180	25	7.25
EMP.14100	GN 1/4-100	265 x 162 x 100	540 x 360 x 240	25	8.5
EMP.14150	GN 1/4-150	265 x 162 x 150	540 x 360 x 320	20	14.25
EMP.14200	GN 1/4-200	265 x 162 x 200	540 x 360 x 180	10	20.5
EMP.1665	GN 1/6-65	176 x 162 x 65	540 x 360 x 120	25	5
EMP.16100	GN 1/6-100	176 x 162 x 100	540 x 360 x 180	25	6
EMP.16150	GN 1/6-150	176 x 162 x 150	540 x 360 x 180	25	14
EMP.16200	GN 1/6-200	176 x 162 x 200	540 x 360 x 320	25	20
EMP.1965	GN 1/9-65	176 x 108 x 65	540 x 360 x 200	25	4.5
EMP.19100	GN 1/9-100	176 x 108 x 100	540 x 360 x 120	25	7.5

AISI 304 Stainless Steel

GN Küvetler - Saplı
GN Containers - With Handle



Kod Code	Ürün Adı Description	Ebatlar Dimension mm	Kutu Ebatları Box Dimension mm	Kutu Adedi Qty In box mm	Fiyatı Price Euro
EMP.S.2165	GN 2/1-65 H	650 x 530 x 65	550 x 660 x 290	10	35
EMP.S.21100	GN 2/1-100 H	650 x 530 x 100	660 x 550 x 360	10	39
EMP.S.21150	GN 2/1-150 H	650 x 530 x 150	660 x 550 x 360	10	58.5
EMP.S.21200	GN 2/1-200 H	650 x 530 x 200	660 x 550 x 360	5	64.5
EMP.S.1165	GN 1/1-65 H	530 x 325 x 65	360 x 540 x 240	20	19
EMP.S.11100	GN 1/1-100 H	530 x 325 x 100	360 x 540 x 355	15	22.5
EMP.S.11150	GN 1/1-150 H	530 x 325 x 150	360 x 540 x 420	15	29
EMP.S.11200	GN 1/1-200 H	530 x 325 x 200	540 x 360 x 420	9	34.5
EMP.S.2465	GN 2/4-65 H	162 x 530 x 65	540 x 360 x 320	20	21.5
EMP.S.24100	GN 2/4-100 H	162 x 530 x 100	540 x 360 x 355	20	23
EMP.S.24150	GN 2/4-150 H	162 x 530 x 150	540 x 360 x 420	15	29.5
EMP.S.2365	GN 2/3-65 H	354 x 325 x 65	540 x 360 x 290	15	17
EMP.S.23100	GN 2/3-100 H	354 x 325 x 100	540 x 360 x 320	15	19
EMP.S.23150	GN 2/3-150 H	354 x 325 x 150	540 x 360 x 360	12	27.5
EMP.S.23200	GN 2/3-200 H	354 x 325 x 200	540 x 360 x 420	10	34
EMP.S.1265	GN 1/2-65 H	325 x 265 x 65	540 x 360 x 290	20	15
EMP.S.12100	GN 1/2-100 H	325 x 265 x 100	540 x 360 x 320	15	17
EMP.S.12150	GN 1/2-150 H	325 x 265 x 150	540 x 360 x 420	20	19
EMP.S.12200	GN 1/2-200 H	325 x 265 x 200	540 x 360 x 420	10	24.5
EMP.S.1365	GN 1/3-65 H	325 x 176 x 65	540 x 360 x 290	20	13.5
EMP.S.13100	GN 1/3-100 H	325 x 176 x 100	540 x 360 x 420	25	16
EMP.S.13150	GN 1/3-150 H	325 x 176 x 150	540 x 360 x 420	24	20.5
EMP.S.13200	GN 1/3-200 H	325 x 176 x 200	540 x 360 x 420	20	28

AISI 304 Stainless Steel

GN Küvetler - Saplı
GN Containers - With Handle

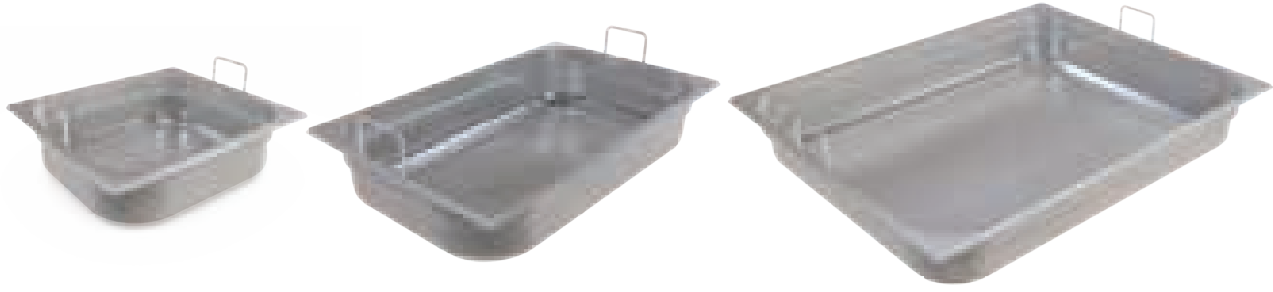

Kod Code	Ürün Adı Description	Ebatlar Dimension mm	Kutu Ebatları Box Dimension mm	Kutu Adedi Qty In box mm	Fiyatı Price Euro
EMP.S.1465	GN 1/4-65 H	265 x 162 x 65	360 x 540 x 340	25	12.5
EMP.S.14100	GN 1/4-100 H	265 x 162 x 100	360 x 540 x 390	25	13.5
EMP.S.14150	GN 1/4-150 H	265 x 162 x 150	360 x 540 x 420	20	17.5
EMP.S.14200	GN 1/4-200 H	265 x 162 x 200	340 x 540 x 360	10	25
EMP.S.1665	GN 1/6-65 H	176 x 162 x 65	540 x 360 x 240	25	9.5
EMP.S.16100	GN 1/6-100 H	176 x 162 x 100	540 x 360 x 320	20	10.5
EMP.S.16150	GN 1/6-150 H	176 x 162 x 150	540 x 360 x 355	20	20
EMP.S.16200	GN 1/6-200 H	176 x 162 x 200	540 x 360 x 420	20	24.5

AISI 304 Stainless Steel

GN Küvetler - Delikli
GN Containers - Perforated



Kod Code	Ürün Adı Description	Ebatlar Dimension mm	Kutu Ebatları Box Dimension mm	Kutu Adedi Qty In box mm	Fiyatı Price Euro
EMP.D.2120	GN 2/1-20 P	650 x 530 x 20	660 x 550 x 120	10	33.5
EMP.D.2140	GN 2/1-40 P	650 x 530 x 40	660 x 550 x 160	10	36
EMP.D.2165	GN 2/1-65 P	650 x 530 x 65	660 x 550 x 180	10	43
EMP.D.21100	GN 2/1-100 P	650 x 530 x 100	660 x 550 x 290	10	48.5
EMP.D.21150	GN 2/1-150 P	650 x 530 x 150	660 x 550 x 360	10	75.5
EMP.D.21200	GN 2/1-200 P	650 x 530 x 200	660 x 550 x 360	5	84
EMP.D.1120	GN 1/1-20 P	530 x 325 x 20	540 x 360 x 120	20	16
EMP.D.1140	GN 1/1-40 P	530 x 325 x 40	540 x 360 x 240	20	18.5
EMP.D.1165	GN 1/1-65 P	530 x 325 x 65	540 x 360 x 240	20	20.5
EMP.D.11100	GN 1/1-100 P	530 x 325 x 100	540 x 360 x 360	15	25.5
EMP.D.11150	GN 1/1-150 P	530 x 325 x 150	540 x 360 x 420	15	34.5
EMP.D.11200	GN 1/1-200 P	530 x 325 x 200	540 x 360 x 420	9	42
EMP.D.2420	GN 2/4-20 P	162 x 530 x 20	540 x 360 x 120	20	15
EMP.D.2440	GN 2/4-40 P	162 x 530 x 40	540 x 360 x 120	20	21
EMP.D.2465	GN 2/4-65 P	162 x 530 x 65	360 x 360 x 290	25	24
EMP.D.24100	GN 2/4-100 P	162 x 530 x 100	540 x 360 x 320	20	16
EMP.D.23150	GN 2/4-150 P	162 x 530 x 150	540 x 360 x 420	20	35
EMP.D.23200	GN 2/3-20 P	354 x 325 x 20	540 x 360 x 240	15	12
EMP.D.2340	GN 2/3-40 P	354 x 325 x 40	540 x 360 x 240	20	13
EMP.D.2365	GN 2/3-65 P	354 x 325 x 65	540 x 360 x 355	20	17.5
EMP.D.23100	GN 2/3-100 P	354 x 325 x 100	540 x 360 x 420	20	20
EMP.D.23150	GN 2/3-150 P	354 x 325 x 150	540 x 360 x 420	15	32
EMP.D.23200	GN 2/3-200 P	354 x 325 x 200	540 x 360 x 420	12	41.5

AISI 304 Stainless Steel

GN Küvetler - Delikli
GN Containers - Perforated



Kod Code	Ürün Adı Description	Ebatlar Dimension mm	Kutu Ebatları Box Dimension mm	Kutu Adedi Qty In box mm	Fiyatı Price Euro
EMP.D.1220	GN 1/2-20 P	325 x 265 x 20	540 x 360 x 120	20	10.5
EMP.D.1240	GN 1/2-40 P	325 x 265 x 40	540 x 360 x 120	20	13.5
EMP.D.1265	GN 1/2-65 P	325 x 265 x 65	540 x 360 x 180	20	15
EMP.D.12100	GN 1/2-100 P	325 x 265 x 100	540 x 360 x 240	15	17.5
EMP.D.12150	GN 1/2-150 P	325 x 265 x 150	540 x 360 x 420	20	20.5
EMP.D.12200	GN 1/2-200 P	325 x 265 x 200	540 x 360 x 290	8	28
EMP.D.1320	GN 1/3-20 P	325 x 176 x 20	540 x 360 x 120	25	9
EMP.D.1340	GN 1/3-40 P	325 x 176 x 40	540 x 360 x 120	25	11.5
EMP.D.1365	GN 1/3-65 P	325 x 176 x 65	540 x 360 x 180	20	13
EMP.D.13100	GN 1/3-100 P	325 x 176 x 100	540 x 360 x 290	25	15.5
EMP.D.13150	GN 1/3-150 P	325 x 176 x 150	540 x 360 x 420	20	22.5
EMP.D.13200	GN 1/3-200 P	325 x 176 x 200	540 x 360 x 320	20	33
EMP.D.1420	GN 1/4-20 P	265 x 162 x 20	540 x 360 x 120	25	7.5
EMP.D.1440	GN 1/4-40 P	265 x 162 x 40	540 x 360 x 120	25	9.5
EMP.D.1465	GN 1/4-65 P	265 x 162 x 65	540 x 360 x 180	25	11
EMP.D.14100	GN 1/4-100 P	265 x 162 x 100	540 x 360 x 240	25	12.5
EMP.D.14150	GN 1/4-150 P	265 x 162 x 150	540 x 360 x 320	20	18
EMP.D.14200	GN 1/4-200 P	265 x 162 x 200	540 x 360 x 180	10	29
EMP.D.1665	GN 1/6-65 P	176 x 162 x 65	540 x 360 x 120	25	7
EMP.D.16100	GN 1/6-100 P	176 x 162 x 100	540 x 360 x 180	25	8.5
EMP.D.16150	GN 1/6-150 P	176 x 162 x 150	540 x 360 x 180	25	22
EMP.D.16200	GN 1/6-200 P	176 x 162 x 200	540 x 360 x 320	25	28

AISI 304 Stainless Steel

Kapak - Standart / Saplı / Kepçeli Kesim
Lids / Standard / with Handle / with Ladle Cut

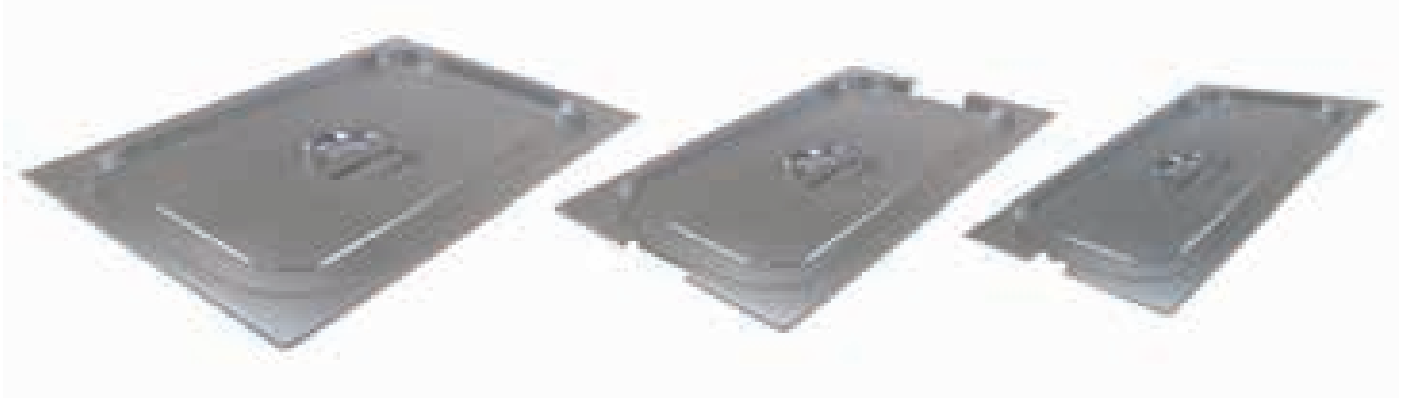

Kod Code	Ürün Adı Description	Ebatlar Dimension mm	Kutu Ebatları Box Dimension mm	Kutu Adedi Qty In box mm	Fiyatı Price Euro
EMP.K.21	GN 2/1 L	650 x 530	550 x 660 x 360	10	21.5
EMP.K.11	GN 1/1 L	530 x 325	540 x 360 x 420	20	10.5
EMP.K.23	GN 2/3 L	354 x 325	540 x 360 x 240	20	9.5
EMP.K.24	GN 2/4 L	530 x 162	540 x 360 x 240	20	8
EMP.K.12	GN 1/2 L	325 x 265	540 x 360 x 240	20	6.5
EMP.K.13	GN 1/3 L	325 x 176	540 x 360 x 180	20	5.5
EMP.K.14	GN 1/4 L	265 x 162	540 x 360 x 180	20	5
EMP.K.16	GN 1/6 L	176 x 162	540 x 360 x 120	20	4
EMP.K.19	GN 1/9 L	176 x 108	540 x 360 x 120	20	3
EMP.KS.21	GN 2/1 LH	650 x 530	660 x 550 x 290	10	23
EMP.KS.11	GN 1/1 LH	530 x 325	360 x 540 x 420	20	13
EMP.KS.23	GN 2/3 LH	354 x 325	360 x 540 x 290	20	10.5
EMP.KS.24	GN 2/4 LH	162 x 530	360 x 540 x 180	20	10.5
EMP.KS.12	GN 1/2 LH	325 x 265	360 x 540 x 240	20	8.5
EMP.KS.13	GN 1/3 LH	325 x 176	360 x 540 x 180	20	7.5
EMP.KS.14	GN 1/4 LH	265 x 162	360 x 540 x 180	20	6
EMP.KS.16	GN 1/6 LH	176 x 162	360 x 540 x 120	20	5.5
EMP.DK.21	GN 2/1 LLC	650 x 530	660 x 550 x 290	10	23
EMP.DK.11	GN 1/1 LLC	530 x 325	360 x 540 x 420	20	13
EMP.DK.23	GN 2/3 LLC	354 x 325	360 x 540 x 290	20	10.5
EMP.DK.12	GN 1/2 LLC	325 x 265	360 x 540 x 240	20	8.5
EMP.DK.13	GN 1/3 LLC	325 x 176	360 x 540 x 180	20	7.5
EMP.DK.14	GN 1/4 LLC	265 x 162	360 x 540 x 180	20	6
EMP.DK.16	GN 1/6 LLC	176 x 162	360 x 540 x 120	20	5.5

AISI 304 Stainless Steel

Kapak - Slikon Eklemlı ve Klipsli
Lids with Silicone Joint / Silicone Joint & Clips

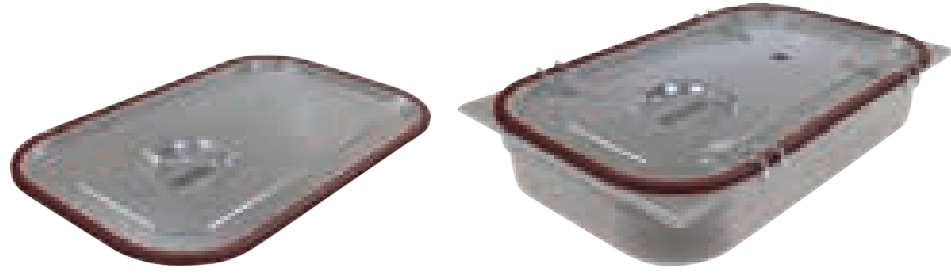

Kod Code	Ürün Adı Description	Ebatlar Dimension mm	Kutu Ebatları Box Dimension mm	Kutu Adedi Qty In box mm	Fiyatı Price Euro
EMP.S.21	GN 2/1 LSJ	650 x 530	550 x 660 x 360	10	69
EMP.S11-H	GDC 1/1 LSJ - Hidden Joint	530 x 325	540 x 360 x 420	10	27.5
EMP.S11	GDC 1/1 LSJ	530 x 325	540 x 360 x 420	20	25.5
EMP.S.23	GDC 2/3 LSJ	354 x 325	540 x 360 x 240	20	18.5
EMP.S.12	GDC 1/2 LSJ	325 x 265	540 x 360 x 240	20	16
EMP.S.13	GDC 1/3 LSJ	325 x 176	270 x 350 x 180	20	13
EMP.S.14	GDC 1/4 LSJ	265 x 162	540 x 360 x 180	20	12
EMP.S.16	GDC 1/6 LSJ	176 x 162	540 x 360 x 120	20	10.5
EMP.S11-O	GN 1/1 LSJC	530 x 325	540 x 360 x 420	10	34.5

AISI 304 Stainless Steel

Polikarbonat Gn Küvetler ve Kapaklar
Polycarbonate GN Containers & Lids



Kod Code	Ürün Adı Description	Ebatlar Dimension mm	Kutu Ebatları Box Dimension mm	Kutu Adedi Qty In box mm	Fiyatı Price Euro
EMP.P.1165	GN 1/1 - 65 Poly	530 x 325 x 65	550 x 350 x 240	6	12
EMP.P.11100	GN 1/1 - 100 Poly	530 x 325 x 100	550 x 350 x 290	6	14
EMP.P.11150	GN 1/1 - 150 Poly	530 x 325 x 150	550 x 350 x 380	6	16.5
EMP.P.1265	GN 1/2 - 65 Poly	325 x 265 x 65	550 x 350 x 250	12	7
EMP.P.12100	GN 1/2 - 100 Poly	325 x 265 x 100	550 x 350 x 290	12	8
EMP.P.12150	GN 1/2 - 150 Poly	325 x 265 x 150	550 x 350 x 380	12	9
EMP.P.1365	GN 1/3 - 65 Poly	325 x 176 x 65	370 x 350 x 230	12	4.5
EMP.P.13100	GN 1/3 - 100 Poly	325 x 176 x 100	370 x 350 x 290	12	5.5
EMP.P.13150	GN 1/3 - 150 Poly	325 x 176 x 150	370 x 350 x 370	12	8
EMP.P.1465	GN 1/4 - 65 Poly	265 x 162 x 65	290 x 350 x 230	12	4
EMP.P.14100	GN 1/4 - 100 Poly	265 x 162 x 100	290 x 350 x 290	12	5
EMP.P.14150	GN 1/4 - 150 Poly	265 x 162 x 150	290 x 350 x 360	12	7
EMP.P.1665	GN 1/6 - 65 Poly	176 x 162 x 65	200 x 350 x 230	12	3
EMP.P.16100	GN 1/6 - 100 Poly	176 x 162 x 100	200 x 350 x 290	12	3.5
EMP.P.16150	GN 1/6 - 150 Poly	176 x 162 x 150	200 x 350 x 360	12	5
EMP.P.1965	GN 1/9 - 65 Poly	176 x 108 x 65	190 x 230 x 230	12	2.5
EMP.P.19100	GN 1/9 - 100 Poly	176 x 108 x 100	190 x 230 x 290	12	3
EMP.P.19150	GN 1/9 - 150 Poly	176 x 108 x 150	190 x 230 x 360	12	3.5
EMP.P.11	GN 1/1 - Poly Lid	530 x 325	210 x 570 x 360	12	10
EMP.P.12	GN 1/2 - Poly Lid	325 x 265	210 x 350 x 300	12	5.5
EMP.P.13	GN 1/3 - Poly Lid	325 x 176	190 x 350 x 210	12	4.5
EMP.P.14	GN 1/4 - Poly Lid	265 x 162	190 x 290 x 190	12	4
EMP.P.16	GN 1/6 - Poly Lid	176 x 162	130 x 200 x 200	12	3
EMP.P.19	GN 1/9 - Poly Lid	176 x 108	130 x 200 x 150	24	2.5

Dondurma Kveti Ice Cream Containers



Kod Code	rn Adı Description	Ebatlar Dimension mm	Kutu Ebatları Box Dimension mm	Kutu Adedi Qty In box mm	Fiyatı Price Euro
EMP.D.311	330 x 145 x 100 (5 lt.)	360 x 170 x 100	540 x 890 x 540	60	14
EMP.D.312	330 x 145 x 120 (6 lt.)	360 x 170 x 120	540 x 890 x 540	50	14.5
EMP.D.315	330 x 145 x 150 (8 lt.)	360 x 170 x 150	540 x 890 x 540	35	26.5

Bain-Marie Sosluk ve Kapakları Bain-Marie Sauce Bins & Lids



Kod Code	rn Adı Description	Ebatlar Dimension mm	Kutu Ebatları Box Dimension mm	Kutu Adedi Qty In box mm	Fiyatı Price Euro
EMP.BM.235	No:3	240 x 210	540 x 360 x 420	20	21
EMP.BM.239	No:4	290 x 210	460 x 890 x 540	30	25.5
EMP.BM.251	No:3	∅ 240	540 x 360 x 180	20	8.5
EMP.BM.346	No:4	∅ 290	540 x 360 x 240	20	10

AISI 304 Stainless Steel



Kod Code	Ürün Adı Description	Ebatlar Dimension mm	Kutu Ebatları Box Dimension mm	Kutu Adedi Qty In box mm	Fiyatı Price Euro
EMP.EV.4425	Sink Unit / Göz Eviye	400 x 400 x 250	460 x 890 x 570	10	57
EMP.EV.4430	Sink Unit / Göz Eviye	400 x 400 x 300	460 x 890 x 570	8	70
EMP.EV.4525	Sink Unit / Göz Eviye	400 x 500 x 250	540 x 890 x 570	10	66
EMP.EV.4530	Sink Unit / Göz Eviye	400 x 500 x 300	540 x 890 x 570	8	80
EMP.EV.454525	Sink Unit / Göz Eviye	450 x 450 x 250	550 x 550 x 660	5	77
EMP.EV.454530	Sink Unit / Göz Eviye	450 x 450 x 300	550 x 550 x 660	5	84
EMP.EV.5525	Sink Unit / Göz Eviye	500 x 500 x 250	550 x 550 x 660	5	77
EMP.EV.5530	Sink Unit / Göz Eviye	500 x 500 x 300	550 x 550 x 660	5	86
EMP.EV.5625	Sink Unit / Göz Eviye	450 x 600 x 300	550 x 660 x 660	5	130
EMP.EV.5630	Sink Unit / Göz Eviye	500 x 600 x 250	550 x 660 x 660	5	100
EMP.EV.3422	Sink Unit / Göz Eviye	500 x 600 x 300	550 x 660 x 660	5	112
EMP.EV.4440	Bar Sink	350 x 400 x 170	460 x 890 x 500	10	38
EMP.EV.44	Water Dispenser Well	410 x 460 x 400	460 x 890 x 510	2	129
EMP.EV.3530	Lid for Water Dispenser	410 x 460	460 x 890 x 510	2	20
EMP.EV.5735	Hand Wash Basin Sink	500 x 500 x 500	500 x 500 x 500	10	47
EMP.EV.5740	Sink Unit / Göz Eviye	300 x 500 x 300	540 x 890 x 570	5	71
EMP.EV.5746	Sink Unit / Göz Eviye	500 x 700 x 350	550 x 750 x 370	1	144
EMP.EV.6833	Sink Unit / Göz Eviye	500 x 700 x 400	550 x 750 x 420	1	144

Sağ Damlalıklı Çiftli Evye
Double Sink Units with Right-Hand Drip Tray



Kod Code	Ürün Adı Description	Ebatlar Dimension mm	Kutu Ebatları Box Dimension mm	Kutu Adedi Qty In box mm	Fiyatı Price Euro
EMP.DEV.101	DbL. Sink Unit (40x40x25)	1400 x 600	1420 x 670 x 520	3	239
EMP.DEV.102	DbL. Sink Unit (40x50x25)	1400 x 600	1420 x 670 x 520	3	257
EMP.DEV.103	DbL. Sink Unit (40x40x25)	1500 x 600	1620 x 670 x 520	2	245
EMP.DEV.104	DbL. Sink Unit (40x50x25)	1500 x 600	1620 x 670 x 520	2	263
EMP.DEV.105	DbL. Sink Unit (40x40x25)	1600 x 600	1620 x 670 x 520	2	251
EMP.DEV.106	DbL. Sink Unit (40x50x25)	1600 x 600	1620 x 670 x 520	2	270
EMP.DEV.107	DbL. Sink Unit (40x50x25)	1800 x 600	1820 x 670 x 520	2	281
EMP.DEV.108	DbL. Sink Unit (40x50x25)	1900 x 600	1920 x 670 x 520	2	287
EMP.DEV.109	DbL. Sink Unit (40x50x25)	2000 x 600	2020 x 670 x 520	2	293
EMP.DEV.110	DbL. Sink Unit (40x50x25)	1400 x 700	1420 x 770 x 520	3	269
EMP.DEV.111	DbL. Sink Unit (40x50x25)	1500 x 700	1620 x 770 x 520	3	275.5
EMP.DEV.112	DbL. Sink Unit (40x50x25)	1600 x 700	1620 x 770 x 520	3	282.5
EMP.DEV.113	DbL. Sink Unit (50x50x30)	1600 x 700	1620 x 770 x 520	2	319.5
EMP.DEV.114	DbL. Sink Unit (50x50x30)	1800 x 700	1820 x 770 x 520	2	333
EMP.DEV.115	DbL. Sink Unit (50x60x30)	1800 x 700	1820 x 770 x 520	2	381
EMP.DEV.116	DbL. Sink Unit (50x50x30)	1900 x 700	1920 x 770 x 520	2	340
EMP.DEV.117	DbL. Sink Unit (50x60x30)	1900 x 700	1920 x 770 x 520	2	388
EMP.DEV.118	DbL. Sink Unit (50x50x30)	2000 x 700	2020 x 770 x 520	2	352
EMP.DEV.119	DbL. Sink Unit (50x60x30)	2000 x 700	2020 x 770 x 520	2	392

AISI 304 Stainless Steel
With 60 mm. Standard Backsplash (100 mm. optional)

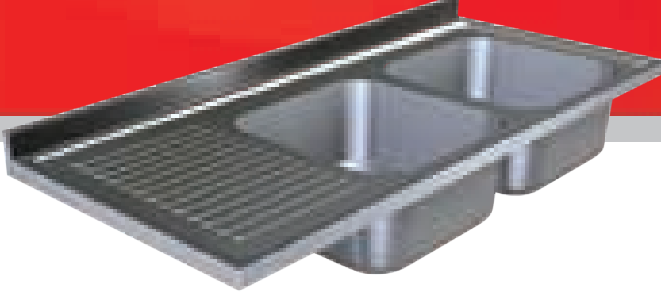

Sol Damlalıklı Çiftli Evye
Double Sink Units with Left-Hand Driptray

Kod Code	Ürün Adı Description	Ebatlar Dimension mm	Kutu Ebatları Box Dimension mm	Kutu Adedi Qty In box mm	Fiyatı Price Euro
EMP.DEV.201	Dbl. Sink Unit (40x40x25)	1400 x 600	1420 x 670 x 520	3	239
EMP.DEV.202	Dbl. Sink Unit (40x50x25)	1400 x 600	1420 x 670 x 520	3	257
EMP.DEV.203	Dbl. Sink Unit (40x40x25)	1500 x 600	1620 x 670 x 520	2	245
EMP.DEV.204	Dbl. Sink Unit (40x50x25)	1500 x 600	1620 x 670 x 520	2	263
EMP.DEV.205	Dbl. Sink Unit (40x40x25)	1600 x 600	1620 x 670 x 520	2	251
EMP.DEV.206	Dbl. Sink Unit (40x50x25)	1600 x 600	1620 x 670 x 520	2	269
EMP.DEV.207	Dbl. Sink Unit (40x50x25)	1800 x 600	1820 x 670 x 520	2	281
EMP.DEV.208	Dbl. Sink Unit (40x50x25)	1900 x 600	1920 x 670 x 520	2	287.5
EMP.DEV.209	Dbl. Sink Unit (40x50x25)	2000 x 600	2020 x 670 x 520	2	293.5
EMP.DEV.210	Dbl. Sink Unit (40x50x25)	1400 x 700	1420 x 770 x 520	3	269
EMP.DEV.211	Dbl. Sink Unit (40x50x25)	1500 x 700	1620 x 770 x 520	2	275.5
EMP.DEV.212	Dbl. Sink Unit (40x50x25)	1600 x 700	1620 x 770 x 520	2	282.5
EMP.DEV.213	Dbl. Sink Unit (50x50x30)	1600 x 700	1820 x 770 x 520	2	319.5
EMP.DEV.214	Dbl. Sink Unit (50x50x30)	1800 x 700	1820 x 770 x 520	2	333
EMP.DEV.215	Dbl. Sink Unit (50x60x30)	1800 x 700	1820 x 770 x 520	2	381
EMP.DEV.216	Dbl. Sink Unit (50x50x30)	1900 x 700	1920 x 770 x 520	2	340
EMP.DEV.217	Dbl. Sink Unit (50x60x30)	1900 x 700	1920 x 770 x 520	2	388
EMP.DEV. 218	Dbl. Sink Unit (50x50x30)	2000 x 700	2020 x 770 x 520	2	352
EMP.DEV. 219	Dbl. Sink Unit (50x60x30)	2000 x 700	2020 x 770 x 520	2	395

AISI 304 Stainless Steel
With 60 mm. Standard Backsplash (100 mm. optional)

Sağ Damlalık Tekli Evye
Single Sink Units with Right-Hand Drip tray



Kod Code	Ürün Adı Description	Ebatlar Dimension mm	Kutu Ebatları Box Dimension mm	Kutu Adedi Qty In box mm	Fiyatı Price Euro
EMP.DEV.301	Single Sink Unit (40x40x25)	1000 x 600	1020 x 670 x 520	3	153
EMP.DEV.302	Single Sink Unit (40x50x25)	1000 x 600	1020 x 670 x 520	3	163
EMP.DEV.303	Single Sink Unit (40x40x25)	1200 x 600	1220 x 670 x 520	3	165
EMP.DEV.304	Single Sink Unit (40x50x25)	1200 x 600	1220 x 670 x 520	3	176
EMP.DEV.305	Single Sink Unit (40x50x25)	1400 x 600	1420 x 670 x 520	3	188
EMP.DEV.306	Single Sink Unit (40x50x25)	1500 x 600	1620 x 670 x 520	2	194
EMP.DEV.307	Single Sink Unit (40x50x25)	1600 x 600	1620 x 670 x 520	2	200
EMP.DEV.308	Single Sink Unit (40x50x25)	1800 x 600	1820 x 670 x 520	2	212
EMP.DEV.309	Single Sink Unit (40x50x25)	2000 x 600	2020 x 670 x 520	2	224
EMP.DEV.310	Single Sink Unit (40x50x25)	1000 x 700	1220 x 770 x 520	3	172.5
EMP.DEV.311	Single Sink Unit (50x50x30)	1000 x 700	1220 x 770 x 520	3	191
EMP.DEV.312	Single Sink Unit (50x50x30)	1200 x 700	1220 x 770 x 520	3	204.5
EMP.DEV.313	Single Sink Unit (40x50x25)	1400 x 700	1420 x 770 x 520	3	200
EMP.DEV.314	Single Sink Unit (50x50x30)	1400 x 700	1420 x 770 x 520	3	218.5
EMP.DEV.315	Single Sink Unit (40x50x25)	1500 x 700	1620 x 770 x 520	2	218
EMP.DEV.316	Single Sink Unit (40x50x25)	1600 x 700	1620 x 770 x 520	2	225.5
EMP.DEV.317	Single Sink Unit (50x50x30)	1600 x 700	1620 x 770 x 520	2	234.5
EMP.DEV.318	Single Sink Unit (50x50x30)	1800 x 700	1820 x 770 x 520	2	249
EMP.DEV.319	Single Sink Unit (50x50x30)	1900 x 700	1920 x 770 x 520	2	258.5
EMP.DEV.320	Single Sink Unit (50x50x30)	2000 x 700	2020 x 770 x 520	2	273

AISI 304 Stainless Steel
With 60 mm. Standard Backsplash (100 mm. optional)

Sol Damlalıklı Tekli Evye
Single Sink Units with Left-Hand Drip Tray



Kod Code	Ürün Adı Description	Ebatlar Dimension mm	Kutu Ebatları Box Dimension mm	Kutu Adedi Qty In box mm	Fiyatı Price Euro
EMP.DEV.401	Single Sink Unit (40x40x25)	1000 x 600	1020 x 670 x 520	3	153
EMP.DEV.402	Single Sink Unit (40x50x25)	1000 x 600	1020 x 670 x 520	3	163.5
EMP.DEV.403	Single Sink Unit (40x40x25)	1200 x 600	1220 x 670 x 520	3	165.5
EMP.DEV.404	Single Sink Unit (40x50x25)	1200 x 600	1220 x 670 x 520	3	176.5
EMP.DEV.405	Single Sink Unit (40x40x25)	1400 x 600	1420 x 670 x 520	3	188
EMP.DEV.406	Single Sink Unit (40x40x25)	1500 x 600	1620 x 670 x 520	2	194
EMP.DEV.407	Single Sink Unit (40x40x25)	1600 x 600	1620 x 670 x 520	2	200
EMP.DEV.408	Single Sink Unit (40x40x25)	1800 x 600	1820 x 670 x 520	2	212.5
EMP.DEV.409	Single Sink Unit (40x40x25)	2000 x 600	2020 x 670 x 520	2	224.5
EMP.DEV.410	Single Sink Unit (40x50x25)	1000 x 700	1220 x 770 x 520	3	172.5
EMP.DEV.411	Single Sink Unit (50x50x30)	1000 x 700	1220 x 770 x 520	3	191
EMP.DEV.412	Single Sink Unit (50x50x30)	1200 x 700	1220 x 770 x 520	3	204.5
EMP.DEV.413	Single Sink Unit (40x50x25)	1400 x 700	1420 x 770 x 520	3	200
EMP.DEV.414	Single Sink Unit (50x50x30)	1400 x 700	1420 x 770 x 520	2	218.5
EMP.DEV.415	Single Sink Unit (40x50x25)	1500 x 700	1620 x 770 x 520	2	218
EMP.DEV.416	Single Sink Unit (40x50x25)	1600 x 700	1620 x 770 x 520	2	225.5
EMP.DEV.417	Single Sink Unit (50x50x30)	1600 x 700	1620 x 770 x 520	2	234.5
EMP.DEV.418	Single Sink Unit (50x50x30)	1800 x 700	1820 x 770 x 520	2	249
EMP.DEV.419	Single Sink Unit (50x50x30)	1900 x 700	1920 x 770 x 520	2	258.5
EMP.DEV.420	Single Sink Unit (50x50x30)	2000 x 700	2020 x 770 x 520	2	273

AISI 304 Stainless Steel
With 60 mm. Standard Backsplash (100 mm. optional)

Damlaliksiz Evye

Single Sink Units without Drip Tray (central sink)



Kod Code	Ürün Adı Description	Ebatlar Dimension mm	Kutu Ebatları Box Dimension mm	Kutu Adedi Qty In box mm	Fiyatı Price Euro
EMP.DEV.501	Single Sink Unit (40x40x25)	600 x 600	740 x 740 x 520	4	129
EMP.DEV.502	Single Sink Unit (40x50x25)	700 x 600	740 x 740 x 520	3	145.5
EMP.DEV.503	Single Sink Unit (40x50x25)	800 x 600	820 x 890 x 620	3	151.5
EMP.DEV.504	Single Sink Unit (40x50x50)	1000 x 600	1020 x 670 x 520	3	163.5
EMP.DEV.505	Single Sink Unit (40x50x25)	1200 x 600	1220 x 670 x 520	3	175.5
EMP.DEV.506	Single Sink Unit (40x50x25)	1400 x 600	1420 x 670 x 520	3	188
EMP.DEV.507	Single Sink Unit (40x50x25)	1600 x 600	1620 x 670 x 520	2	200
EMP.DEV.508	Single Sink Unit (40x50x25)	1800 x 600	1820 x 670 x 520	2	212
EMP.DEV.509	Single Sink Unit (40x50x25)	2000 x 600	2020 x 670 x 520	2	224.5
EMP.DEV.510	Single Sink Unit (40x50x25)	2200 x 600	2420 x 770 x 520	2	236.5
EMP.DEV.511	Single Sink Unit (40x50x25)	600 x 700	770 x 770 x 520	3	145
EMP.DEV.512	Single Sink Unit (40x50x25)	700 x 700	740 x 740 x 520	3	152
EMP.DEV.514	Single Sink Unit (50x50x30)	700 x 700	770 x 770 x 520	3	170.5
EMP.DEV.515	Single Sink Unit (50x50x30)	1200 x 700	1220 x 770 x 520	3	204.5
EMP.DEV.516	Single Sink Unit (50x50x30)	1400 x 700	1420 x 770 x 520	2	218
EMP.DEV.517	Single Sink Unit (50x50x30)	1600 x 700	1620 x 770 x 520	2	232
EMP.DEV.518	Single Sink Unit (50x50x30)	2000 x 700	2020 x 770 x 520	2	259
EMP.DEV.519	Single Sink Unit (50x50x30)	2200 x 700	2220 x 770 x 520	2	273
EMP.DEV.520	Single Sink Unit (50x50x30)	2400 x 700	2420 x 770 x 520	2	286.5

AISI 304 Stainless Steel
With 60 mm. Standard Backsplash (100 mm. optional)



Damlalıksız Çift Evyeler

Double Sink Units without Driptray (central sink)

Kod Code	Ürün Adı Description	Ebatlar Dimension mm	Kutu Ebatları Box Dimension mm	Kutu Adedi Qty In box mm	Fiyatı Price Euro
EMP.DEV.601	Double Sink Unit (40x40x25)	1200 x 600	1220 x 670 x 520	3	226.5
EMP.DEV.602	Double Sink Unit (40x50x25)	1200 x 600	1220 x 670 x 520	3	244.5
EMP.DEV.603	Double Sink Unit (40x50x25)	1400 x 600	1420 x 670 x 520	3	257
EMP.DEV.604	Double Sink Unit (40x50x25)	1600 x 600	1620 x 670 x 520	2	269
EMP.DEV.605	Double Sink Unit (40x50x25)	1800 x 600	1820 x 670 x 520	2	281
EMP.DEV.606	Double Sink Unit (40x50x25)	2000 x 600	2020 x 670 x 520	2	293.5
EMP.DEV.607	Double Sink Unit (40x50x25)	2200 x 600	2220 x 670 x 520	2	305.5
EMP.DEV.608	Single Sink Unit (40x25x30)	2400 x 600	2420 x 670 x 520	2	318
EMP.DEV.609	Double Sink Unit (40x50x25)	1200 x 700	1220 x 770 x 520	3	256.5
EMP.DEV.610	Double Sink Unit (50x50x30)	1200 x 700	1220 x 770 x 520	3	292
EMP.DEV.611	Double Sink Unit (50x50x30)	1400 x 700	1420 x 770 x 520	3	305.5
EMP.DEV.612	Double Sink Unit (40x50x25)	1600 x 700	1620 x 770 x 520	2	287
EMP.DEV.613	Double Sink Unit (50x50x30)	1800 x 700	1820 x 770 x 520	2	333
EMP.DEV.614	Double Sink Unit (50x50x30)	2000 x 700	2020 x 770 x 520	2	347
EMP.DEV.615	Double Sink Unit (50x50x30)	2200 x 700	2220 x 770 x 520	2	360.5
EMP.DEV.616	Double Sink Unit (50x50x30)	2400 x 700	2420 x 770 x 520	2	374

Damlalıksız Üçlü Evye

Triple Sink Units without Driptray



Kod Code	Ürün Adı Description	Ebatlar Dimension mm	Kutu Ebatları Box Dimension mm	Kutu Adedi Qty In box mm	Fiyatı Price Euro
EMP.DEV.701	Triple Sink Unit (40x40x25)	1800 x 600	182 x 670 x 520	2	322
EMP.DEV.702	Triple Sink Unit (40x50x25)	1800 x 600	182 x 670 x 520	2	351
EMP.DEV.703	Triple Sink Unit (40x40x25)	1900 x 600	192 x 670 x 520	2	329
EMP.DEV.704	Triple Sink Unit (40x50x25)	1900 x 600	192 x 670 x 520	2	357
EMP.DEV.705	Triple Sink Unit (50x50x30)	1800 x 700	182 x 770 x 520	2	421
EMP.DEV.706	Triple Sink Unit (50x50x30)	1900 x 700	192 x 670 x 520	2	427.5
EMP.DEV.707	Triple Sink Unit (50x50x30)	2000 x 700	202 x 670 x 520	2	434.5

Dört Damlalıklı Tepsili Evye

Quad Sink Unit without Driptray



Kod Code	Ürün Adı Description	Ebatlar Dimension mm	Kutu Ebatları Box Dimension mm	Kutu Adedi Qty In box mm	Fiyatı Price Euro
EMP.DEV.710	Quad Sink Unit (40x50x25)	2400 x 600	242 x 670 x 520	2	456.5

AISI 304 Stainless Steel
With 60 mm. Standard Backsplash (100 mm. optional)



Çift Damlalıklı Tek ve Çift Evyeler
Single & Double Sink Units with Double Driptray

Kod Code	Ürün Adı Description	Ebatlar Dimension mm	Kutu Ebatları Box Dimension mm	Kutu Adedi Qty In box mm	Fiyatı Price Euro
EMP.DEV.901	Single Sink 40x40x25	1400 x 600	1420 x 670 x 520	2	177.5
EMP.DEV.902	Single Sink 40x50x25	1400 x 600	1420 x 670 x 520	2	188
EMP.DEV.903	Single Sink 40x40x25	1600 x 600	1620 x 670 x 520	2	190
EMP.DEV.904	Single Sink 40x50x25	1600 x 600	1620 x 670 x 520	2	200
EMP.DEV.905	Single Sink 40x40x25	1800 x 600	1820 x 670 x 520	2	202
EMP.DEV.906	Single Sink 40x50x25	1800 x 600	1820 x 670 x 520	2	212.5
EMP.DEV.907	Single Sink 40x50x25	2000 x 600	2020 x 670 x 520	2	224.5
EMP.DEV.908	Single Sink 50x50x30	1400 x 700	1420 x 770 x 520	2	221
EMP.DEV.909	Single Sink 50x50x30	1600 x 700	1620 x 770 x 520	2	232
EMP.DEV.910	Single Sink 50x50x30	1800 x 700	1820 x 770 x 520	2	245.5
EMP.DEV.911	Single Sink 50x50x30	1900 x 700	1920 x 770 x 520	2	252.5
EMP.DEV.912	Single Sink 50x50x30	2000 x 700	2020 x 770 x 520	2	259.5
EMP.DEV.913	Double Sink 40x40x25	1600 x 600	1620 x 670 x 520	2	251
EMP.DEV.914	Double Sink 40x50x25	1800 x 600	1820 x 670 x 520	2	289
EMP.DEV.915	Double Sink 40x40x25	1900 x 600	1920 x 670 x 520	2	282
EMP.DEV.916	Double Sink 40x50x25	1900 x 600	1920 x 670 x 520	2	295
EMP.DEV.917	Double Sink 50x50x30	1800 x 700	1820 x 770 x 520	2	333
EMP.DEV.918	Double Sink 50x50x30	1900 x 700	1920 x 770 x 520	2	340
EMP.DEV.919	Double Sink 50x50x30	2000 x 700	2020 x 770 x 520	2	347

Sebze Yıkama Üniteleri
Vegetable Washing Units



Kod Code	Ürün Adı Description	Ebatlar Dimension mm	Kutu Ebatları Box Dimension mm	Kutu Adedi Qty In box mm	Fiyatı Price Euro
EMP.ST.1277	VEG. Wash. 51x96x30	1200 x 700	1220 x 770 x 520	1	302.5
EMP.ST.1477	VEG. Wash. 51x128x30	1400 x 700	1420 x 770 x 520	1	344.5
EMP.ST.1877	VEG. Wash. 51x160x30	1800 x 700	1820 x 770 x 520	1	507

AISI 304 Stainless Steel

AISI 304 Stainless Steel
Ready to use all included (one or two water inlet) Knee Control 3

Bain - Marie Havuzları
Bain - Marie Wells



Kod Code	Ürün Adı Description	Ebatlar Dimension mm	Kutu Ebatları Box Dimension mm	Kutu Adedi Qty In box mm	Fiyatı Price Euro
EMP.BEH.001	B.M. Well 6 GN 1/1, Benmari	510x1920x150	2120 x 770 x 520	3	203.5
EMP.BEH.002	B.M. Well 6 GN 1/1, Benmari	510x1920x180	2120 x 770 x 520	3	214.5
EMP.BEH.003	B.M. Well 6 GN 1/1, Benmari	510x1920x210	2120 x 770 x 520	3	225.5
EMP.BEH.004	B.M. Well 5 GN 1/1, Benmari	510x1600x150	1820 x 770 x 520	3	133
EMP.BEH.005	B.M. Well 5 GN 1/1, Benmari	510x1600x180	1820 x 770 x 520	3	141
EMP.BEH.006	B.M. Well 5 GN 1/1, Benmari	510x1600x210	1820 x 770 x 520	3	152
EMP.BEH.007	B.M. Well 4 GN 1/1, Benmari	510x1280x150	1420 x 770 x 520	3	110.5
EMP.BEH.008	B.M. Well 4 GN 1/1, Benmari	510x1280x180	1420 x 770 x 520	3	117
EMP.BEH.009	B.M. Well 4 GN 1/1, Benmari	510x1280x210	1420 x 770 x 520	3	128
EMP.BEH.010	B.M. Well 3 GN 1/1, Benmari	510 x 960 x 150	1220 x 770 x 520	3	95
EMP.BEH.011	B.M. Well 3 GN 1/1, Benmari	510 x 960 x 180	1220 x 770 x 520	3	107
EMP.BEH.012	B.M. Well 3 GN 1/1, Benmari	510 x 960 x 210	1220 x 770 x 520	3	112.5
EMP.BEH.013	B.M. Well 2 GN 1/1, Benmari	510 x 630 x 150	770 x 770 x 520	3	75
EMP.BEH.014	B.M. Well 2 GN 1/1, Benmari	510 x 630 x 180	770 x 770 x 520	3	85
EMP.BEH.015	B.M. Well 2 GN 1/1, Benmari	510 x 630 x 210	770 x 770 x 520	3	92
EMP.BEH.016	B.M. Well 1 GN 1/1, Benmari	300 x 505 x 150	770 x 770 x 520	10	51.5
EMP.BEH.017	B.M. Well 1 GN 1/1, Benmari	300 x 505 x 180	770 x 770 x 520	10	61
EMP.BEH.018	B.M. Well 1 GN 1/1, Benmari	300 x 505 x 210	770 x 770 x 520	10	66
EMP.BEH.019	B.M. Well 3 GN 1/1, Benmari	245 x 465 x 120	1220 x 770 x 520	3	31
EMP.BEH.020	B.M. Well 10 GN 1/1, Benmari	510 x 800 x 120	1220 x 770 x 520	3	89
EMP.BEH.021	B.M. Well 10 GN 1/1, Benmari	510 x 800 x 180	1220 x 770 x 520	3	117.5

Bain - Marie Havuzları (Monoblock)

Bain - Marie Wells (Monoblock)



Kod Code	rn Adı Description	Ebatlar Dimension mm	Kutu Ebatları Box Dimension mm	Kutu Adedi Qty In box mm	Fiyatı Price Euro
EMP.BEH.001-M	3 GN 1/1, Monoblock	1120x610x150	1220 x 670 x 520	3	120
EMP.BEH.002-M	3 GN 1/1, Monoblock	1120x610x180	1220 x 670 x 520	3	133
EMP.BEH.003-M	4 GN 1/1, Monoblock	1440x610x150	1620 x 670 x 520	3	137.5
EMP.BEH.004-M	4 GN 1/1, Monoblock	1440x610x180	1620 x 670 x 520	3	146.5
EMP.BEH.005-M	5 GN 1/1, Monoblock	1760x610x150	1820 x 670 x 520	3	154
EMP.BEH.006-M	5 GN 1/1, Monoblock	1760x610x180	1820 x 670 x 520	3	165
EMP.BEH.007-M	6 GN 1/1, Monoblock	2090x610x150	2120 x 670 x 520	3	220
EMP.BEH.008-M	6 GN 1/1, Monoblock	2090x610x180	2120 x 670 x 520	3	236

AISI 304 Stainless Steel
Crosswise +50 mm., Lengthwise +80 mm.
Suitable for built in Saladbars



Bain - Marie Havuzları
Bain - Marie Units with Uppertable

Kod Code	rn Adı Description	Ebatlar Dimension mm	Kutu Ebatları Box Dimension mm	Kutu Adedi Qty In box mm	Fiyatı Price Euro
EMP.BEH.001-T	3 GN 1/1	1140x700x180	1220 x 770 x 520	3	226
EMP.BEH.002-T	3 GN 1/1	1200x700x180	1220 x 770 x 520	3	230
EMP.BEH.003-T	3 GN 1/1	1400x700x180	1420 x 770 x 520	3	242
EMP.BEH.004-T	3 GN 1/1	1600x700x180	1620 x 770 x 520	3	254
EMP.BEH.005-T	GN 3 x 1/1 + 1/1 (Neutral)	1400x700x180	1420 x 770 x 520	3	255
EMP.BEH.006-T	GN 3 x 1/1 + 1/1 (Neutral)	1500x700x180	1620 x 770 x 520	3	261
EMP.BEH.007-T	GN 3 x 1/1 + 1/1 (Neutral)	1600x700x180	1620 x 770 x 520	3	266.5
EMP.BEH.008-T	3 GN 1/1 + 3 GN 1/1	2100x700x180	2120 x 770 x 520	3	449
EMP.BEH.009-T	4 GN 1/1	1500x700x180	1620 x 770 x 520	3	277
EMP.BEH.010-T	4 GN 1/1	1600x700x180	1620 x 770 x 520	3	295
EMP.BEH.011-T	4 GN 1/1	2000x700x180	2020 x 770 x 520	3	318
EMP.BEH.012-T	GN 4 x 1/1 + 1/1 (Neutral)	1800x700x180	1820 x 770 x 520	3	309
EMP.BEH.013-T	GN 4 x 1/1 + 1/1 (Neutral)	2000x700x180	2020 x 770 x 520	3	345.5
EMP.BEH.014-T	5 GN 1/1	1800x700x180	1820 x 770 x 520	3	355.5
EMP.BEH.015-T	6 GN 1/1	2100x700x180	2120 x 770 x 520	3	423.5



İthal Ürünler
Import Products

EMPERO

İçin Mutfak / Kitchen of Business

www.juniorprince.com



- * **Buz Makineleri / Ice Makers**
- * **Kar Buz Makinesi / Ice Flakers**
- * **Şişe Soğutucular / Bottle Coolers**
- * **Soğutmalı Suşi Teşhir Dolapları / Refrigerated Sushi Display Cases**
- * **Teşhir Üniteleri-Soğutmalı -Isıtmalı / Display Units - Cold & Hot**
- * **Dik Tip Teşhir Üniteleri-Soğuk / Upright Display Units - Cold**
- * **Dondurmalı Teşhir Dolapları / Ice Cream Display Cabinet**
- * **Dondurma Makineleri / Soft Ice Cream Machines**
- * **Filtre Kahve ve Sıcak Çikolata Makinesi / Filter Coffee and Hot Chocolate Machine**
- * **Katı Meyve Presi - Portakal Sıkma Makinesi / Juice Extractor Citrus Press - Orange Juicer**
- * **Bar Blenderi (High Power) - Soğan Doğrama Makinesi - Hız Kontrollü Mikser / Bar Blender (High Power) - Cutter - Speed Controlled Mixer**
- * **Elektrikli Döner Kesme Bıçağı - Çorbalık / Electric Doner Blade - Soup Kettle**
- * **Mikrodalga Fırın (Endüstriyel Tip) - İndüksiyon Ocakları / Microwave Oven (Industrial Type) - Induction Cookers**
- * **Eİ Blenderi / Immersion Blender**
- * **Gıda Dilimleme Makinesi / Food Slicer**
- * **Termobox-600 - Hamburger Presi / Thermobox-600 - Hamburger Pres**
- * **Ön Yıkama Duş Üniteleri / Pre-washing Units**
- * **Elektrikli Fritöz / Electrical Fryers**
- * **Elektrikli Izgaralar / Electrical Grill**
- * **Elektrikli & Gazlı Bakır Çay Kazanları / Electric & Tea Copper Covered Tea Boilers**
- * **Bakır Davlumbazlar / Copper Hood**
- * **Açık & Kapalı Bakır Izgaralar / Open & Close Copper Grill**
- * **Kahveci Güzeli / Coffee on Sand**

Buz Makineleri Ice Makers



Kod Code	Ürün Adı Description	Ebatlar Dimension mm			Ağırlık Weight kg	Net Net m ³	Kapasite Capacity kg	Fiyatı Price Euro
		a	b	c				
JP.30	Buz Makinesi Ice Makers	405x515x750			40	0.16	30	1.850
JP.50	Buz Makinesi Ice Makers	465x595x795			58	0.22	50	2.450
JP.90	Buz Makinesi Ice Makers	715x595x945			69	0.4	90	3.600
JP.125	Buz Makinesi Ice Makers	715x700x1050			89	0.53	125	4.200
JP.175	Buz Makinesi Ice Makers	860x700x1050			95	0.63	175	5.340
JP.250	Buz Makinesi (Alt Hazne Dahil) Ice Makers (Bin Included)	762x819x1571			135	0.98	250	7.585
JP.450	Buz Makinesi (Alt Hazne Dahil) Ice Makers (Bin Included)	762x819x1831			155	1.14	450	9.500

Türkçe

BUZ MAKİNELERİ

JP.30

- 30 kg buz kapasitesi.
- 15 kg depo haznesi.
- Alüminyum panelli bakır borulu evaporatör.
- Kayar kapı.
- Paslanmaz çelik gövde.

JP.50

- 50 kg buz kapasitesi.
- 20 kg depo haznesi.
- Alüminyum panelli bakır borulu evaporatör.
- Kayar kapı.
- Paslanmaz çelik gövde.

JP.90

- 90 kg buz kapasitesi.
- 35 kg depo haznesi.
- Alüminyum panelli bakır borulu evaporatör.
- Kayar kapı.
- Paslanmaz çelik gövde.

JP.125

- 125 kg buz kapasitesi.
- 60 kg depo haznesi.
- Alüminyum panelli bakır borulu evaporatör.
- Kayar kapı.
- Paslanmaz çelik gövde.

JP.175

- 175 kg buz kapasitesi.
- 75 kg depo haznesi.
- Alüminyum panelli bakır borulu evaporatör.
- Kayar kapı.
- Paslanmaz çelik gövde.

JP.250

- 250 kg buz kapasitesi.
- 200 kg depo haznesi.
- Alüminyum panelli bakır borulu evaporatör.
- Paslanmaz çelik gövde.

JP.450

- 450 kg buz kapasitesi.
- 200 kg depo haznesi.
- Alüminyum panelli bakır borulu evaporatör.
- Paslanmaz çelik gövde.

English

ICE MAKERS

JP.30

- Production Capacity:30 kg/day
- Bin capacity:15 kg
- Evaporator with aluminium panel and copper pipe.
- Sliding door.
- Stainless steel body.

JP.50

- Production Capacity:50 kg/day
- Bin capacity:20 kg
- Evaporator with aluminium panel and copper pipe.
- Sliding door.
- Stainless steel body.

JP.90

- Production Capacity: 90 kg/day
- Bin capacity:35 kg
- Evaporator with aluminium panel and copper pipe.
- Sliding door.
- Stainless steel body.

JP.125

- Production Capacity: 125 kg/day
- Bin capacity:60 kg
- Evaporator with aluminium panel and copper pipe.
- Sliding door.
- Stainless steel body.

JP.175

- Production Capacity: 175 kg/day
- Bin capacity:75 kg
- Evaporator with aluminium panel and copper pipe.
- Sliding door.
- Stainless steel body.

JP.250

- Production Capacity: 250 kg/day
- Bin capacity:200 kg
- Evaporator with aluminium panel and copper pipe.
- Stainless steel body.

JP.450

- Production Capacity: 450 kg/day
- Bin capacity:200 kg
- Evaporator with aluminium panel and copper pipe.
- Stainless steel body.



JP.250 - JP.450

Kar Buz Makinesi Ice Flakers



JP.50-K

JP.135-K



Kod Code	Ürün Adı Description	Ebatlar Dimension mm			Ağırlık Weight kg	Net Net m ³	Kapasite Capacity kg	Fiyatı Price Euro
		a	b	c				
JP.85-K	Kar Buz Makinesi Ice Flaker	465x595x790			55	0.22	85	4.200
JP.150-K	Kar Buz Makinesi (Alt Hazne Dahil) Ice Flakers (Bin Included)	559x800x1356			60	0.61	150	6.700
JP.200-K	Kar Buz Makinesi (Alt Hazne Dahil) Ice Flakers (Bin Included)	762x819x1646			70	1.03	200	7.350
JP.400-K	Kar Buz Makinesi (Alt Hazne Dahil) Ice Flakers (Bin Included)	1219x819x1731			92	1.73	400	10.000

Türkçe

KAR BUZ MAKİNESİ

JP.85-K

- 85 kg buz kapasitesi.
- 20 kg depo haznesi.
- Alüminyum panelli bakır borulu evaporatör.
- Kayar kapı.
- Paslanmaz çelik gövde.

JP.150-K

- 150 kg buz kapasitesi.
- 150 kg depo haznesi.
- Alüminyum panelli bakır borulu evaporatör.
- Kayar kapı.
- Paslanmaz çelik gövde.

JP.200-K

- 200 kg buz kapasitesi.
- 220 kg depo haznesi.
- Alüminyum panelli bakır borulu evaporatör.
- Kayar kapı.
- Paslanmaz çelik gövde.

JP.400-K

- 400 kg buz kapasitesi.
- 400 kg depo haznesi.
- Alüminyum panelli bakır borulu evaporatör.
- Paslanmaz çelik gövde.

English

ICE FLAKERS

JP.85-K

- Production Capacity:85 kg/day
- Bin capacity:20 kg
- Evaporator with aluminium panel and copper pipe.
- Sliding door.
- Stainless steel body.

JP.150-K

- Production Capacity: 150 kg/day
- Bin capacity:150 kg
- Evaporator with aluminium panel and copper pipe.
- Sliding door.
- Stainless steel body.

JP.200-K

- Production Capacity: 200 kg/day
- Bin capacity:220 kg
- Evaporator with aluminium panel and copper pipe.
- Sliding door.
- Stainless steel body.

JP.400-K

- Production Capacity: 400 kg/day
- Bin capacity:400 kg
- Evaporator with aluminium panel and copper pipe.
- Stainless steel body.



JP.150-K



JP.400-K

Şişe Soğutucular Bottle Coolers



Çarpma Kapaklı / Hinged Doors

Kod Code	Ürün Adı Description	Ebatlar Dimension mm			Ağırlık Weight kg	Güç Power kw	Kapasite Capacity lt	Fiyatı Price Euro
		a	b	c				
JP.SS.2	Şişe Soğutucular (2 Kapılı) Bottle Coolers (2 Doors)	920x500x870			42	0.26	208	1.100



Çarpma Kapaklı / Hinged Doors

Kod Code	Ürün Adı Description	Ebatlar Dimension mm			Ağırlık Weight kg	Güç Power kw	Kapasite Capacity lt	Fiyatı Price Euro
		a	b	c				
JP.SS.3	Şişe Soğutucular (3 Kapılı) Bottle Coolers (3 Doors)	1380x500x870			52	0.30	310	1.265



Türkçe

ŞİŞE SOĞUTUCULAR

- 220 V-230 V -1 +N -50 60 Hz elektrik gücü.
- PVC kaplı galvaniz sac.
- CFC Free soğutma gazı: R 134A / R 404A
- Dış ortam sıcaklığı: +32 °C
- Fanlı soğutma.
- Dijital termometre & termostat.
- Otomatik defrost.
- Kapılarda kilit.
- Özel kapı menteşe sistemi.
- Temizlenebilir ve sökülebilir manyetik kapı contası.

English

BOTTLE COOLERS

- 220 V-230 V -1 +N -50 60 Hz electrical power.
- PVC coated galvanized steel.
- "CFC Free" refrigerant gas: R 134A / R 404 A
- + 32 °C ambient temp.
- Fan cooling.
- Digital thermometer and thermostat.
- Automatic defrosting.
- Lock system in the door.
- Special door hinge system.
- Removable and easy to clean magnetic door.



Soğutmalı Suşi Teşhir Dolapları
 Refrigerated Sushi Display Cases

Kod Code	Ürün Adı Description	Ebatlar Dimension mm			Ağırlık Weight kg	Güç Power kw	Kapasite Capacity Gn 1/3	Fiyatı Price Euro
		a	b	c				
JP.STD-6	Soğutmalı Suşi Teşhir Dolabı Refrigerated Sushi Display Cases	1447	387	240	49	0.13	6	2.350



Kod Code	Ürün Adı Description	Ebatlar Dimension mm			Ağırlık Weight kg	Güç Power kw	Kapasite Capacity Gn 1/3	Fiyatı Price Euro
		a	b	c				
JP.STD-8	Soğutmalı Suşi Teşhir Dolabı Refrigerated Sushi Display Cases	1797	387	240	52	0.13	8	2.700

Türkçe
SOĞUTMALI SUŞİ TEŞHİR DOLABI

- 220 V-230 V -1 +N -50 60 Hz elektrik gücü.
- -1/+1 °C çalışma ısısı.
- Temperli bombe cam.
- Açılabilir ve kolay temizlenebilir cam.
- Led aydınlatma.
- Dijital termometre & termostat.
- Otomatik defrost.
- EASYCLEAN TRAYS SYSTEM® hijyenik kullanım sağlar.

English
REFRIGERATED SUSHI DISPLAY CASES

- 220 V-230 V -1 +N -50 60 Hz electrical power.
- -1/+1 °C working temperature.
- Tempered curved glass.
- Lifts up glass to remove for cleaning.
- Led lighting.
- Digital thermometer and thermostat.
- Automatic defrosting.
- EASYCLEAN TRAYS SYSTEM® provide hygienic usage.



Teşhir Üniteleri-Soğutmalı ve Isıtmalı Display Units - Cold & Hot



Kod Code	Ürün Adı Description	Ebatlar Dimension mm			Ağırlık Weight kg	Güç Power kw	Net Net m³	Kapasite Capacity lt	Fiyatı Price Euro
		a	b	c					
JP.120.S	Teşhir Ünitesi-Soğutmalı Display Unit - Cold	702	568	686	64	0.16	0.20	120	1.150



Kod Code	Ürün Adı Description	Ebatlar Dimension mm			Ağırlık Weight kg	Güç Power kw	Net Net m³	Kapasite Capacity lt	Fiyatı Price Euro
		a	b	c					
JP.160.S	Teşhir Ünitesi-Soğutmalı Display Unit - Cold	880	568	686	71	0.16	0.30	160	1.270



Kod Code	Ürün Adı Description	Ebatlar Dimension mm			Ağırlık Weight kg	Güç Power kw	Net Net m³	Kapasite Capacity lt	Fiyatı Price Euro
		a	b	c					
JP.120.I	Teşhir Ünitesi-Isıtmalı Display Unit - Hot	678	578	670	48	1.1	0.20	120	850



Kod Code	Ürün Adı Description	Ebatlar Dimension mm			Ağırlık Weight kg	Güç Power kw	Net Net m³	Kapasite Capacity lt	Fiyatı Price Euro
		a	b	c					
JP.160.I	Teşhir Ünitesi-Isıtmalı Display Unit - Hot	857	578	670	56	1.5	0.30	160	970



Türkçe

TEŞHİR ÜNİTESİ-SOĞUTMALI

- 220V / 50hz elektrik gücü.
- Çalışma aralığı 0 °C + 12 °C
- R-134 A soğutucu gaz.
- Led aydınlatma.
- Çift cam.
- Ayarlanabilir 2 adet raf.
- Dijital sıcaklık kontrolü.

TEŞHİR ÜNİTESİ-ISITMALI

- 220 V - 50Hz. Enerji.
- Led aydınlatma.
- Ayarlanabilir ısı kontrolü.
- Ayarlanabilir 3 adet raf.

English

DISPLAY UNIT - COLD

- 220V / 50hz electrical power.
- Working temperature: 0 °C + 12 °C
- R-134 A refrigerant gas.
- Led lighting system.
- Double glass.
- 2 adjustable shelves.
- Digital temperature control.

DISPLAY UNIT - HOT

- 220 V - 50Hz. Energy.
- Led lighting system.
- Thermostatic control.
- 3 adjustable shelves



Dik Tip Teşhir Üniteleri-Soğuk
Upright Display Units - Cold



Kod Code	Ürün Adı Description	Ebatlar Dimension mm			Ağırlık Weight kg	Net Net m ³	Kapasite Capacity lt	Fiyatı Price Euro
		a	b	c				
JP.400.S	Dik Tip Teşhir Üniteleri-Soğutmalı Upright Display Units - Cold	650	650	1900	100	0.81	400	2.950

Türkçe

DİK TİP TEŞHİR ÜNİTELERİ-SOĞUTMALI

JP.400.S

- 220V / 50hz elektrik gücü.
- Çalışma aralığı 0 °C + 10 °C
- R-134 A soğutucu gaz.
- Led aydınlatma.
- Çift cam.
- 2 si frenli 4 adet teker.
- Otomatik defrost.
- Dijital sıcaklık kontrolü.

English

UPRIGHT DISPLAY UNITS - COLD

JP.400.S

- 220V / 50hz electrical power.
- Working temperature: 0 °C + 10 °C
- R-134 A refrigerant gas.
- Led lighting system.
- Double glass.
- 4 castors with 2 brakes.
- Automatic defrost.
- Digital temperature control.

Dondurma Teşhir Dolapları Ice Cream Display Cabinet



Kod Code	Ürün Adı Description	Ebatlar Dimension mm			Ağırlık Weight kg	Güç Power kw	Kapasite Capacity container	Fiyatı Price Euro
		a	b	c				
JP.PLS.DT-12	Dondurma Teşhir Dolapları Ice Cream Display Cabinet	1235	1205	1175	250	1.6	12x5 lt	10.450
JP.PLS.DT-18	Dondurma Teşhir Dolapları Ice Cream Display Cabinet	1775	1205	1175	280	2.4	18x5 lt	13.250
JP.PLS.DT-24	Dondurma Teşhir Dolapları Ice Cream Display Cabinet	2280	1065	1410	340	3.1	24x5 lt	15.000



Türkçe

DONDURMA TEŞHİR DOLAPLARI

- 400 V-50 Hz çalışma gücü.
- R404 A soğutucu gaz.
- -18 / -22 °C çalışma ısısı.
- Semi-Hermetik kompresör.
- Otomatik defrost özelliği.
- Kendinden rezistanslı çift levhali cam.
- 45° kadar açılabilir ön cam ile kolay temizlik imkanı.
- Led aydınlatma.

English

ICE CREAM DISPLAY CABINET

- 400 V - 50 Hz Electrical power.
- R404 A refrigerant gas.
- -18 / -22 °C working temperature.
- Semi-Hermetic compressor.
- Automatic defrosting feature.
- Double laminated glass with built in resistance for high humidity condensation.
- Tilt-down front access with glazed glass up to 45° angle for easy routine maintenance and cleaning procedure.
- Led lighting.

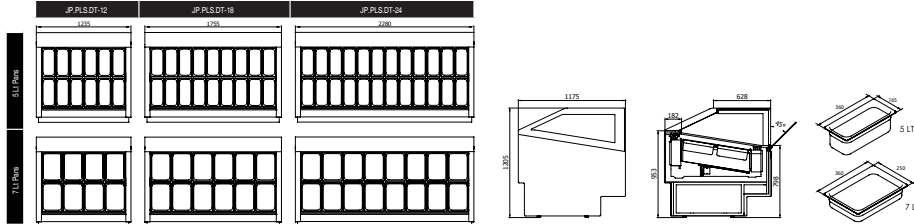

Kod Code	Ürün Adı Description	Ebatlar Dimension mm			Ağırlık Weight kg	Güç Power kw	Kapasite Capacity container	Fiyatı Price Euro
		a	b	c				
JP.DTB-48	Dondurma Teşhir Dolapları Ice Cream Display Cabinet	900	1065	1410	206	0.65	8	7.050
JP.DTB-60	Dondurma Teşhir Dolapları Ice Cream Display Cabinet	1240	1065	1410	246	0.75	12	8.000



Türkçe

DONDURMA TEŞHİR DOLAPLARI

- 220 V-50 Hz çalışma gücü.
- R404 A soğutucu gaz.
- -18 / -22 °C çalışma ısısı.
- Kolay temizlik imkanı sağlayan ön cam.
- Led aydınlatma.
- Dijital termostat.
- 480 ve 600 lt Kapasite.
- Paslanmaz çelik gövde.

English

ICE CREAM DISPLAY CABINET

- 220 V - 50 Hz Electrical power.
- R404 A refrigerant gas.
- -18 / -22 °C working temperature.
- Front glass could be opened for cleaning.
- Led lighting.
- Digital thermostat.
- 480 and 600 lt capacity.
- Stainless steel body.



NEW**İthal Ürünler**
Import Products**Dondurma Makineleri**
Soft Ice Cream Machines

Kod Code	Ürün Adı Description	Ebatlar Dimension mm			Ağırlık Weight kg	Kapasite Capacity kg / h	Fiyatı Price Euro
		a	b	c			
JP.1500	Dondurma Makineleri-Pompasız Soft Ice Cream Machines- With Gravity	450x670x840			90	18.75	9.100
JP.1500-P	Dondurma Makineleri-Pompalı Soft Ice Cream Machines- With Pump	385x730x900			125	18.75	13.850

Türkçe**DONDURMA MAKİNELERİ**

- 230 V-50 Hz çalışma gücü.
- Saatte 250 Kûlah kapasitesi.
- JP.1500 Modeli için; 16 lt hazne kapasitesi.
- JP.1500-P Modeli için; 11 lt hazne kapasitesi.
- 1,5 lt silindir kapasitesi.
- Kendiliğinden kapanan valfler sayesinde sarfiyat önleme.
- Paslanmaz çelik gövde

English**SOFT ICE CREAM MACHINES**

- 230 V - 50 Hz Electrical power.
- 250 cones capacity.
- For JP.1500 model;16 lt hopper capacity.
- For JP.1500-P model;11 lt hopper capacity.
- 1,5 lt cylinder capacity.
- Self closing valves avoid wastage.
- Stainless steel body.

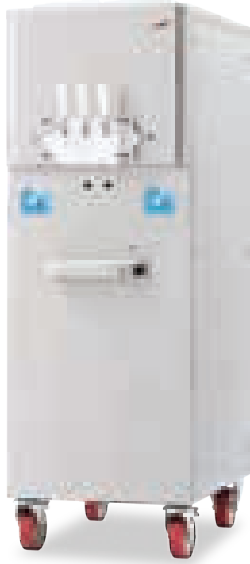

Kod Code	Ürün Adı Description	Ebatlar Dimension mm			Ağırlık Weight kg	Kapasite Capacity kg / h	Fiyatı Price Euro
		a	b	c			
JP.4000	Dondurma Makineleri-Pompasız Soft Ice Cream Machines- With Gravity	550x730x1550			213	37.5	16.000
JP.4000-P	Dondurma Makineleri-Pompalı Soft Ice Cream Machines- With Pump	550x730x1550			255	37.5	25.500

Türkçe**DONDURMA MAKİNELERİ**

- 400 V-50 Hz çalışma gücü.
- Saatte 500 Kûlah kapasitesi.
- JP.4000 Modeli için; 2x15 lt hazne kapasitesi.
- JP.4000-P Modeli için; 2x11 lt hazne kapasitesi.
- 2x1,5 lt silindir kapasitesi.
- Kendiliğinden kapanan valfler sayesinde sarfiyat önleme.
- Paslanmaz çelik gövde

English**SOFT ICE CREAM MACHINES**

- 400 V - 50 Hz Electrical power.
- 500 cones capacity.
- For JP.4000 model; 2x15 lt hopper capacity.
- For JP.4000-P model;2x11 lt hopper capacity.
- 2x1,5 lt cylinder capacity.
- Self closing valves avoid wastage.
- Stainless steel body.



Filtre Kahve ve Sıcak Çikolata Makinesi

Filter Coffee and Hot Chocolate Machine



Kod Code	Ürün Adı Description	Ebatlar Dimension mm			Ağırlık Weight kg	Güç Power kw	Net Net m³	Kapasite Capacity lt	Fiyatı Price Euro
		a	b	c					
JP.FK.01	Filtre Kahve Makinesi Filter Coffee Machine	205	410	450	6	1.96	0.04	1.7	400



Kod Code	Ürün Adı Description	Ebatlar Dimension mm			Ağırlık Weight kg	Güç Power kw	Net Net m³	Kapasite Capacity lt	Fiyatı Price Euro
		a	b	c					
JP.SC.01	Sıcak Çikolata Makinesi Hot Chocolate Machine	410	280	580	3	1	0.06	10	635



Türkçe

FİLTRE KAHVE MAKİNESİ

- 220 V. 50 Hz. enerji.
- 5 dakika içinde kaynatma süresi.
- Tank kapasitesi: 1,7 Litre.
- Cezve kapasitesi: 1,7 Litre

SICAK ÇİKOLATA MAKİNESİ

- 220 V. 50 Hz. enerji.
- 0°- 85° C termostat kontrol ünitesi.

English

FILTER COFFEE MACHINE

- 220 V. 50 Hz energy.
- Boiling time: 5 minute.
- Tank Capacity: 1,7 Litre.
- Pot Capacity: 1,7 Litre.

HOT CHOCOLATE MACHINE

- 220 V. 50 Hz energy.
- 0°- 85° C Thermostat control unit.



Katı Meyve Presi - Portakal Sıkma Makineleri
 Juice Extractor Citrus Press - Orange Juicers

Kod Code	Ürün Adı Description	Ebatlar Dimension mm			Ağırlık Weight kg	Güç Power kw	Net Net m³	Kapasite Capacity lt	Fiyatı Price Euro
		a	b	c					
JP.KM.01	Katı Meyve Presi Juice Extractor Citrus Press	205	310	360	4	0.03	0.04	1	450



Kod Code	Ürün Adı Description	Ebatlar Dimension mm			Ağırlık Weight kg	Güç Power kw	Net Net m³	Kapasite Capacity lt	Fiyatı Price Euro
		a	b	c					
JP.PR.01	Portakal Sıkma Makinesi Orange Juicer	260	254	470	9	0.18	0.03	220	270



Kod Code	Ürün Adı Description	Ebatlar Dimension mm			Ağırlık Weight kg	Güç Power kw	Net Net m³	Kapasite Capacity lt	Fiyatı Price Euro
		a	b	c					
JP.PR.02	Portakal Sıkma Makinesi (Paslanmaz Çelik) Orange Juicer (Stainless Steel)	280	200	470	9	0.23	0.03	340	420



Kod Code	Ürün Adı Description	Ebatlar Dimension mm			Ağırlık Weight kg	Güç Power kw	Net Net m³	Kapasite Capacity lt	Fiyatı Price Euro
		a	b	c					
JP.PR.03	Portakal Sıkma Makinesi (Manuel) Manuel Citrus Juicer	200	240	500	6		0.02	110	155

Türkçe
KATI MEYVE PRESİ

- 220-240 V - 430W. motor gücü.
- Otomatik posa atım sistemi.
- Turbo düğmesi.
- 6300 d/dk
- Paslanmaz çelik gövde.

PORTAKAL SIKMA MAKİNELERİ
JP.PR.01

- 220 V-1800 d/dk devir gücü.
- Sessiz,yüksek performanslı,enerji tasarruflu çalışma imkanı.
- Paslanmaz çelik gövde.

JP.PR.02

- 220 V-980 d/dk devir gücü.
- Sessiz,yüksek performanslı,enerji tasarruflu çalışma imkanı.
- Paslanmaz çelik gövde ve sıcakcak haznesi.

English
JUICE EXTRACTOR CITRUS PRESS

- Motor power: 220-240 V - 430W
- Automatic pulp ejection.
- Turbo button.
- 6300 circuit per a minute.
- Stainless steel body.

ORANGE JUICERS
JP.PR.01

- 220 V-1800 rpm motor power.
- Energy saving usage with silent operation.
- Stainless steel body.

JP.PR.02

- 220 V-980 rpm motor power.
- Energy saving usage with silent operation.
- Stainless steel body on top reservoir.

Bar Blenderi (High Power) - Soğan Doğrama Makinesi - Hız Kontrollü Mikser Bar Blender (High Power) - Cutter - Speed Controlled Mixer



Kod Code	Ürün Adı Description	Ebatlar Dimension mm			Ağırlık Weight kg	Güç Power kw	Net Net m³	Kapasite Capacity lt	Fiyatı Price Euro
		a	b	c					
JP.BB.01	Bar Blenderi Bar Blender	200	225	511	5	1.5	0.02	2	350

Buz kırabilme özelliği
Ice crusher blender



Kod Code	Ürün Adı Description	Ebatlar Dimension mm			Ağırlık Weight kg	Güç Power kw	Net Net m³	Kapasite Capacity lt	Fiyatı Price Euro
		a	b	c					
JP.SD.01	Soğan Doğrama Makinesi Cutter	490	265	335	18	0.37	0.4	7.5	330



Kod Code	Ürün Adı Description	Ebatlar Dimension mm			Ağırlık Weight kg	Güç Power kw	Net Net m³	Kapasite Capacity lt	Fiyatı Price Euro
		a	b	c					
JP.MK.107	Hız Kontrollü Mikser Speed Controlled	415	250	410	17	0.32	0.04	7	700



Türkçe

BAR BLENDERİ

- 220V.50-60 Hz çalışma gücü.
- Çelik dişli.
- **Titanium bıçak.**

SOĞAN DOĞRAMA MAKİNESİ

- 0,37 kw 2800 d/dk 220 v.motor gücü.
- 260mm tencere çapı. 150 mm tencere derinliği.
- Paslanmaz çelik kazan.

HIZ KONTROLLÜ MİKSER

- 220V.50Hz Enerji.
- Çıkarılabilir paslanmaz çelik kazan.
- Hijyenik ve emniyetli kullanım.
- 1 adet çırpma teli.
- 1 adet hamur baltası.
- 1 adet çırpma paleti.

English

BAR BLENDER

- 220V.50-60 Hz operating voltage.
- Steel gearwheel.
- **Titanium blade**

CUTTER

- Motor power:0.37 Kw 2800 D/Dk-220 V
- Bowl dimension (diameter/depth) 260/150 mm
- Stainless steel body.

SPEED CONTROLLED MIXER

- 220V.50Hz Energy.
- Removable stainless steel tank.
- Safety switch and hygienic usage.
- 1 Of Whisk.
- 1 Of Dough hook.
- 1 Of Mixing Paddle.

Elektrikli Döner Kesme Bıçağı - Çorbalık
Electric Doner Blade - Soup Kettle



Kod Code	Ürün Adı Description	Ebatlar Dimension mm			Ağırlık Weight kg	Güç Power kw	Net Net m³	Fiyatı Price Euro
		a	b	c				
JP.100E	Elektrikli Döner Kesme Bıçağı Electric Doner Blade	113	190	150	3	0.23	0.05	550
JP.D.01	Düz Bıçak Smooth Blade	Ø10						30
JP.T.01	Tırtırlı Bıçak Knurled Blade	Ø10						42



Kod Code	Ürün Adı Description	Ebatlar Dimension mm			Ağırlık Weight kg	Güç Power kw	Net Net m³	Kapasite Capacity lt	Fiyatı Price Euro
		a	b	c					
JP.CRP.01-P	Çorbalık - Paslanmaz Gövdeli Soup Kettle Stainless Steel Body	360	355	200	17	0.4	0.03	10	160



Kod Code	Ürün Adı Description	Ebatlar Dimension mm			Ağırlık Weight kg	Güç Power kw	Net Net m³	Kapasite Capacity lt	Fiyatı Price Euro
		a	b	c					
JP.CRP.01	Çorbalık Soup Kettle	360	400	200	18	0.4	0.03	8	125

Türkçe

ÇORBALIK

- 220V.50 Hz çalışma gücü.
- Çıkarılabilir paslanmaz çelik iç hazne.
- Hijyenik ve emniyetli kullanım.

ELEKTRİKLİ DÖNER KESME BIÇAĞI

- 220 V - 2200 d/dk motor gücü.
- Bıçak çapı: 100 mm
- Kesme kalınlığı: 0 ~ 8 mm
- Bıçak bileme aparatı.

English

SOUP KETTLE

- 220V.50 Hz operating voltage.
- Removable stainless steel reservoir.
- Hygienic and safe usage.

ELECTRIC DONER BLADE

- Motor power: 2200 rpm 220 V
- Blade diameter: 100 mm
- Cutting thickness: 0 ~ 8 mm
- Blade sharpening tool

Mikrodalga Fırın (Endüstriyel Tip) - İndüksiyon Ocakları Microwave Oven (Industrial Type) - Induction Cookers



Kod Code	Ürün Adı Description	Ebatlar Dimension mm			Ağırlık Weight kg	Güç Power kw	Net Net m³	Fiyatı Price Euro
		a	b	c				
JP.MD.01	Mikrodalga Fırın Microwave Oven	511	421	285	25	1	0.06	440

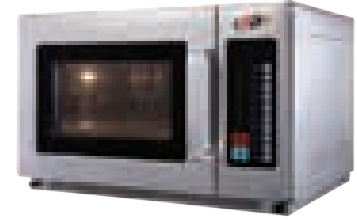

Kod Code	Ürün Adı Description	Ebatlar Dimension mm			Ağırlık Weight kg	Güç Power kw	Net Net m³	Fiyatı Price Euro
		a	b	c				
JP.ID.01	İndüksiyon Ocağı Induction Cooker	340	440	120	8	0.5 - 3	0.02	400



Kod Code	Ürün Adı Description	Ebatlar Dimension mm			Ağırlık Weight kg	Güç Power kw	Net Net m³	Fiyatı Price Euro
		a	b	c				
JP.IDW.02	İndüksiyon Ocağı (Wok) Induction Cooker (Wok)	340	440	120	8	0.5 - 3	0.02	430



Kod Code	Ürün Adı Description	Ebatlar Dimension mm			Ağırlık Weight kg	Güç Power kw	Net Net m³	Fiyatı Price Euro
		a	b	c				
JP.ID01-A	Ankastre İndüksiyon Ocağı Dropin Induction Cooker	430	326	110	6	3.5	0.02	450



Türkçe

MİKRODALGA FIRIN

- 220 V. 50 Hz enerji
- 25 lt kapasite.
- Dokunmatik-Led ışıklı kontrol ekranı.
- Paslanmaz çelik iç ve dış çerçeve.
- Farklı çalışma seviyeleri.
- 10- 8 dk ayarlı zamanlayıcı

İNDÜKSİYON OCAĞI

- 220 V / 50 Hz. enerji
- Seramik tabla.
- Zaman ayarlı kontrol panosu.

English

MICROWAVE OVEN

- 220 V. 50 Hz operating voltage.
- Capacity: 25 lt
- Touch screen LCD control panel.
- Stainless steel interior and out frame.
- Different levels of operating.
- Timer: 10- 8 minute.

INDUCTION COOKER

- 220 V / 50 Hz. energy.
- Ceramic plect.
- Control panel with timer.

El Blenderleri Immersion Blender



Kod Code	Ürün Adı Description	Ebatlar Dimension mm		Ağırlık Weight kg	Net Net m ³	Güç Power kw	Kapasite Capacity lt	Fiyatı Price Euro
		a	b					
JP.BLE.01	El Blenderi 30 cm (Çırpıcı ve Kesici) Immersion Blender 30cm (Whisk Tool and Cutter)	97x640		3.4	0.02	300	20-40	645
JP.BLE.02	El Blenderi 50 cm (Çırpıcı ve Kesici) Immersion Blender 50cm (Whisk Tool and Cutter)	122x760		4.5	0.04	460	20-100	750

Türkçe

EL BLENDERİ

JP.BLE.01

- Toplam Uzunluğu: 640 mm
- Mikser Uzunluğu: 205 mm
- Kesici Uzunluğu: 300 mm
- Motor Gücü: 300 Watt
- Motor Devri(Mikser):0-9500 devir/dak
- Motor Devri(Kesici):0-900 devir/dak
- Blender Kapasitesi:20-40 lt
- Mikser Kapasitesi:5-20 lt

JP.BLE.02

- Toplam Uzunluğu: 760 mm
- Mikser Uzunluğu: 245 mm
- Kesici Uzunluğu: 410 mm
- Motor Gücü: 460 Watt
- Motor Devri(Mikser):3000-9500 devir/dak
- Motor Devri (Kesici):300-900 devir/dak
- Blender Kapasitesi:40-100 lt
- Mikser Kapasitesi:10-20 lt.

English

IMMERSION BLENDER

JP.BLE.01

- Total Length: 640 mm
- Mixer Length: 205 mm
- Whisk Length: 300 mm
- Motor Power: 300 Watt
- Mixer Speed:0-9500 rpm
- Whisk Speed:0-900 rpm
- Mixer Capacity:20-40 lt
- Whisk Capacity:5-20 lt.

JP.BLE.02

- Total Length: 760 mm
- Mixer Length: 245 mm
- Whisk Length: 410 mm
- Motor Power: 460 Watt
- Mixer speed:3000-9500 rpm
- Whisk Speed : 300 to 900 rpm
- Mixer Capacity:40-100 lt
- Whisk Capacity:10-20 lt

Çırpıcı ve kesici fiyatlara dahildir.
Whisk tool and cutter included in the price.



Motor
Motor



Çırpıcı
Whisk Tool

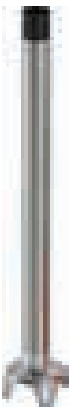

Kesici
Cutter

Gıda Dilimleme Makinesi Food Slicer



Kod Code	Ürün Adı Description	Ebatlar Dimension mm			Ağırlık Weight kg	Güç Power kw	Net Net m³	Bıçak Çapı Diameter mm	Fiyatı Price Euro
		a	b	c					
JP.GD.220	Gıda Dilimleme Makinesi Food Slicer	410x400x350			12	0.21	0.06	220	550
JP.GD.250	Gıda Dilimleme Makinesi Food Slicer	535x475x490			16	0.24	0.12	250	630
JP.GD.300	Gıda Dilimleme Makinesi Food Slicer	575x412x460			16	0.27	0.11	300	925

Türkçe

GIDA DİLİMLEME MAKİNESİ

- 220 V-50 Hz Elektrik bağlantısı.
- Hijyenik ve paslanmaz gövde.
- Anodiz alüminyumdan imal.
- Bıçak bileme aparatı.
- Ayarlanabilir kesme kalınlığı.

English

FOOD SLICER

- 220 V-50 Hz Electrical connection.
- Hygienic and stainless steel body.
- Manufactured by anodised aluminium.
- Blade sharpener tool.
- Adjustable slice thickness.



Termobox-600 - Hamburger Presi
Thermobox-600 - Hamburger Press



Kod Code	Ürün Adı Description	Ebatlar Dimension mm			Ağırlık Weight kg	Güç Power kw	Net Net m³	Kapasite Capacity lt	Fiyatı Price Euro
		a	b	c					
JP.HM.01	Hamburger Presi Hamburger Press	275	220	295	8		0.22		220



Kod Code	Ürün Adı Description	Ebatlar Dimension mm			Ağırlık Weight kg	Net Net m³	Uzunluk Length mt	Fiyatı Price Euro
		a	b	c				
JP.TMB.600	Termobox-600 Thermobox-600	465	610	630	15	0.18	200	220
JP.TMB.600-K	Termobox-600 (Kilitli) Thermobox-600 (Locker)	465	610	630	15	0.18	215	235

Türkçe

HAMBURGER PRESİ

- 130 mm et kesme çapı.
- Paslanmaz çelik gövde.

TERMOBOX

JP.TMB.600

- Gri, kahve, haki, mavi, siyah renk seçenekleri.
- 38-40 kg / m3 poliüretan enjekte edilmiş çift cidarlı gövde.
- Dayanıklılığı arttıran monoblok gövde.
- Kırılmaz PA6 kilitler.
- -40° C soğuğa +100° C sığağa kadar dayanıklılık.
- 4 saat içerisinde; sıcak yemeklerde saatte ortalama 1.5° C ısı kaybı, soğuk yemeklerde ise 1° C ısınma.
- JP.TMB.600 kapasitesi:
12 x GN 1/1 -20
6 x GN 1/1 -65
4 x GN 1/1 -100
3 x GN 1/1 -150
2 x GN 1/1 -200

English

HAMBURGER PRESS

- Meat diameter:130 mm
- Stainless steel body.

THERMOBOX

JP.TMB.600

- Grey, brown, khaki, blue, black colour options.
- Double jacket enjected with 38-40 kg / m3 polyurethane density.
- Monoblock body provides durable usage.
- Unbreakable PA6 lockers.
- Durable between -40° C +100° C
- 1.5° C loss of heat for hot foods, 1° C heat gain for cold foods per hour in 4 hours.
- Capacity for JP.TMB.600:
12 x GN 1/1 -20
6 x GN 1/1 -65
4 x GN 1/1 -100
3 x GN 1/1 -150
2 x GN 1/1 -200

Ön Yıkama Duş Üniteleri Pre-washing Units

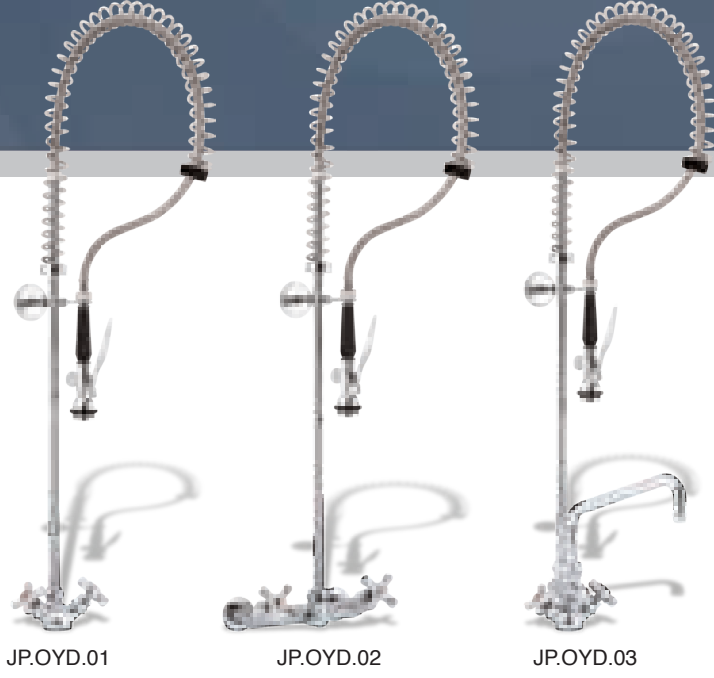

Kod Code	Ürün Adı Description	Fiyatı Price Euro
JP.OYD.01	Ön Yıkama Duşu (Tezgaha Monte) Counter Mounted Pre-washing Unit	155
JP.OYD.02	Ön Yıkama Duşu (Duvara Monte) Wall Mounted Pre-washing Unit	180
JP.OYD.03	Ön Yıkama Duşu (Armatürlü Tezgaha Monte) Counter Mounted Pre-wash Spray Unit with Double Batteries	190

Türkçe

ÖN YIKAMA DUŞ ÜNİTELERİ

- Lekesiz yıkama özelliği.
- Kontrollü basınç sistemi.
- Dayanıklı yapı.

English

PRE-WASHING UNITS

- Spotless washing.
- Controlled pressure system.
- Durable structure.

Elektrikli Fritöz
Electrical Fryers



Kod Code	Ürün Adı Description	Ebatlar Dimension mm			Ağırlık Weight kg	Güç Power kw	Net Net m³	Kapasite Capacity lt	Fiyatı Price Euro
		a	b	c					
JP.FE.01	Elektrikli Fritöz-Tekli Electrical Fryers - Single	290	550	360	5	2.3	0,57	6	295



Kod Code	Ürün Adı Description	Ebatlar Dimension mm			Ağırlık Weight kg	Güç Power kw	Net Net m³	Kapasite Capacity lt	Fiyatı Price Euro
		a	b	c					
JP.FE.02	Elektrikli Fritöz-Çiftli Electrical Fryers - Double	580	550	360	10	2.3x2	1,15	6+6	550

Türkçe

ELEKTRİKLİ FRITÖZLER

- 220 V-50 HZ Enerji.
- Tahliye Vanaları.
- Paslanmaz Çelik Gövde.

English

ELECTRICAL FRYERS

- 220 V-50 Hz Energy.
- Drainage valve.
- Stainless steel body.

Elektrikli Izgaralar Electrical Grill



Kod Code	Ürün Adı Description	Ebatlar Dimension mm			Ağırlık Weight kg	Güç Power kw	Net Net m³	Kapasite Capacity lt	Fiyatı Price Euro
		a	b	c					
JP.IE.01	Elektrikli Izgara-Düz Electric Grill - Smooth	550	430	240	14	3	0.5		395



Kod Code	Ürün Adı Description	Ebatlar Dimension mm			Ağırlık Weight kg	Güç Power kw	Net Net m³	Kapasite Capacity lt	Fiyatı Price Euro
		a	b	c					
JP.IE.02	Elektrikli Izgara-Düz Electric Grill - Smooth	730	470	240	25	4.4	0.82		475



Kod Code	Ürün Adı Description	Ebatlar Dimension mm			Ağırlık Weight kg	Güç Power kw	Net Net m³	Kapasite Capacity lt	Fiyatı Price Euro
		a	b	c					
JP.IE.03	Elektrikli Izgara-Düz+Oluklu Electric Grill - Smooth +Ribbed	730	470	240	25	4.4	0.82		575

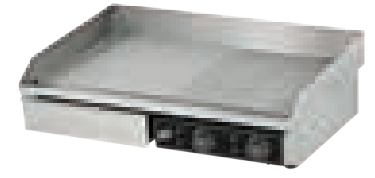

Türkçe

ELEKTRİKLİ IZGARALAR

- 220 V-50 Hz Elektrik Bağlantısı.
- Paslanmaz çelik gövde.

English

ELECTRIC GRILL

- 220 V-50 Hz Electric energy.
- Stainless steel body.

Elektrikli & Gazlı Bakır Çay Kazanları
 Electric & Tea Copper Covered Tea Boilers

Kod Code	Ürün Adı Description	Ebatlar Dimension mm			Ağırlık Weight kg	Güç Power kw	Net Net m³	Kapasite Capacity lt	Fiyatı Price Euro
		a	b	c					
JP.BCK.02	Elektrikli & Gazlı Bakır Çay Kazanları Electric & Tea Copper Covered Tea Boilers	670x350x530			25	6	0.12	30	1.000



Kod Code	Ürün Adı Description	Ebatlar Dimension mm			Ağırlık Weight kg	Güç Power kw	Net Net m³	Kapasite Capacity lt	Fiyatı Price Euro
		a	b	c					
JP.BCK.03	Elektrikli & Gazlı Bakır Çay Kazanları Electric & Tea Copper Covered Tea Boilers	830x350x530			27	7.25	0.16	45	1.075



Kod Code	Ürün Adı Description	Ebatlar Dimension mm			Ağırlık Weight kg	Güç Power kw	Net Net m³	Kapasite Capacity lt	Fiyatı Price Euro
		a	b	c					
JP.BCK.04	Elektrikli & Gazlı Bakır Çay Kazanları Electric & Tea Copper Covered Tea Boilers	1000x350x530			30	9.82	0.19	60	1.150

Demlik fiyata dahil değildir.
Tea pot is not included in the price.



Kod Code	Ürün Adı Description	Fiyatı Price Euro
JP.DM.01	Demlik Tea Pot	40

Türkçe
ELEKTRİKLİ & GAZLI BAKIR ÇAY KAZANLARI

- 2 Kw rezistans gücü.
- Bakır kaplama gövde.

English
ELECTRIC & TEA COPPER COVERED TEA BOILERS

- 2 Kw resistance.
- Copper covered body.

Bakır Davlumbazlar Copper Hood



Kod Code	Ürün Adı Description	Ebatlar Dimension mm			Net Net m ²	Fiyatı Price Euro
		a	b	c		
JP.BD.02	Bakır Davlumbaz Copper Hood	790	420	350	0.17	345



Kod Code	Ürün Adı Description	Ebatlar Dimension mm			Net Net m ²	Fiyatı Price Euro
		a	b	c		
JP.BD.03	Bakır Davlumbaz Copper Hood	950	450	350	0.22	435



Kod Code	Ürün Adı Description	Ebatlar Dimension mm			Net Net m ²	Fiyatı Price Euro
		a	b	c		
JP.BD.04	Bakır Davlumbaz Copper Hood	1200	500	400	0.22	490



JP.BCK.03 + JP.BD.02

Açık & Kapalı Bakır Izgaralar
Open & Close Copper Grill



Kod Code	Ürün Adı Description	Ebatlar Dimension mm			İç Ebat Interior Dimension mm	Ağırlık Weight kg	Fiyatı Price Euro
		a	b	c			
JP.BIA.01	Bakır Izgara - Açık Model Copper Grill - Open Model	1200x600x1250			1000x400x125	55	1.650
JP.BIA.02	Bakır Izgara - Açık Model Copper Grill - Open Model	1500x600x1250			1300x400x125	70	1.900
JP.BIA.03	Bakır Izgara - Açık Model Copper Grill - Open Model	2000x600x1250			1800x400x125	85	2.150



Kod Code	Ürün Adı Description	Ebatlar Dimension mm			İç Ebat Interior Dimension mm	Ağırlık Weight kg	Fiyatı Price Euro
		a	b	c			
JP.BIK.01	Bakır Izgara - Kapalı Model Copper Grill - Close Model	1000x600x1250			900x450x125	50	1.450
JP.BIK.02	Bakır Izgara - Kapalı Model Copper Grill - Close Model	1200x600x1250			1100x450x125	60	1.575
JP.BIK.03	Bakır Izgara - Kapalı Model Copper Grill - Close Model	1500x600x1250			1400x400x125	75	1.795

Kahveci Güzeli
Coffee on Sand



Kod Code	Ürün Adı Description	Ebatlar Dimension mm			Fiyatı Price Euro
		a	b	c	
JP.KG.01	Kahveci Güzeli Coffee on Sand	900x600x2000			1.750

Türkçe

KAHVECİ GÜZELİ

- 40x40 cm, 1.5 kw pişirme alanı.
- Bakır Gövde.

English

COFFEE ON SAND

- Cooking surface 40x40 cm, 1.5 kw
- Cooper Covered Body.



Teknik Servis Listesi

Technical Service List

S.Kodu	Bölge	Yetkili Servis	İsim	Telefon	Fax	Cep
S-001	KONYA	EMPERO A.Ş./FABR.	YUSUF DEVEBACAK	444 15 60	0332 239 12 11-10	0530 602 40 45
S-002	KONYA	EMPERO A.Ş./FABR.	SALİH TASA	444 15 60	0332 239 12 11-10	0533 151 28 91
S-003	ADANA	ÖZGER END. MUT.	SEDAT ÖZGER	0553 285 40 40	-	0553 285 40 40
S-004	ADANA	GÜRSOY KLİMA	MURAT GÜRSOY	0532 764 37 79	-	0532 764 37 79
S-005	ADANA	KROMSAN TEKNİK	MAHMUT NİHAT ÖZTÜRK	0322 226 91 61	0322 226 91 61	0532 317 56 80
S-006	ADIYAMAN	ORHAN TEKNİK SOĞ.	ORHAN BAĞIR	0416 214 32 81	0416 214 32 81	0535 270 73 87
S-007	AFYON	MAVİ ALEV	FATİH BEYTÜR	0272 214 73 84	0272 214 73 84	0542 781 71 05
S-008	AĞRI	GÜVEN SOĞUTMA	ALİ KAHRAMAN	0472 215 11 59	0472 215 11 59	0544 292 48 13
S-009	AKSARAY	ŞAHİN SOĞUTMA	TUNCAY KARATAY	0382 212 94 84	0382 212 10 30	0533 387 12 08
S-010	AMASYA	UYUM TEKNİK	SERKAY AYDIN	0545 789 98 55	-	0545 789 98 55
S-011	ANKARA	İREM TEKNİK	RAŞİT ÇELEN	0312 341 00 39	0312 341 45 50	0535 676 55 99
S-012	ANKARA	AYDIN SERV.	MUSTAFA AYDIN	0312 319 05 00	0312 319 05 86	0532 432 68 38
S-013	ANKARA	YAĞIZ TEKNİK	H.BASRI MIZRAK	0312 341 71 62	0312 341 71 62	0533 383 34 51
S-014	ANKARA	AK-SER GRUP END.	AZİZ KEÇECİ	0312 384 23 62	0312 284 23 63	0533 455 93 42
S-015	ANKARA	RAMSE TEKNİK	ÖMER İŞIKSOY	0312 395 00 59	0312 395 00 59	0536 832 00 01
S-016	ANKARA	YİĞİT TEKNİK	MERT ÜNAL	0312 377 00 33	-	0541 361 21 52
S-017	ANTALYA	ALTEK END.	ALİ ALTUNAY	0242 341 40 83	0242 340 01 54	0545 684 24 00
S-018	ANTALYA	SENKRON END.	DENİZ KAYA	0242 346 32 40	0242 346 32 73	0533 307 65 92
S-019	ANTALYA-ALANYA	ÇÖZÜM TEKNİK	MEHMET ŞENOL	0242 519 15 15	0242 511 81 66	0532 793 31 29
S-020	ANTALYA-ALANYA	AKBAŞ ENDÜSTRİYEL	HASAN AKBAŞ	-	-	0536 619 70 49
S-021	ANTALYA-MANAVGAT	ÖZGÜR TEKNİK	ÖZGÜR TAYLAN	0242 743 27 19	0242 743 27 19	0535 528 82 59
S-022	ANTALYA-MANAVGAT	SEKTÖR MUTFAK	VELİ DOLU	0242 743 30 93	0242 746 75 66	0532 705 88 79
S-023	AYDIN-KUŞADASI	GÖKOĞLU SOĞUTMA	BARAN GÖKOĞLU	0256 612 94 80	0256 612 94 80	0533 368 64 95
S-024	AYDIN-NAZİLLİ	EFE SOĞUTMA	LEVENT TERZİOĞLU	0256 312 01 88	0256 312 01 88	0535 216 38 06
S-025	BALIKESİR	NARLI TEKNİK	MEHMET ALİ DÜŞÜNEN	0266 239 08 89	0266 239 08 89	0536 524 96 29

Teknik Servis Listesi

Technical Service List

S.Kodu	Bölge	Yetkili Servis	İsim	Telefon	Fax	Cep
S-026	BALIKESİR	NARLI TEKNİK	MEHMET ALİ DÜŞÜNEN	0266 239 08 89	0266 239 08 89	0536 524 96 29
S-027	BALIKESİR	ÖNDER TEKNİK	ÇİHAN ÖNDER	0266 241 20 11	0266 241 20 12	0532 706 62 45
S-028	BALIKESİR-EDREMİT	ATASOY SOĞUTMA	MUSTAFA KEMAL ATASOY	0266 385 51 56	-	0546 484 84 44
S-029	BARTIN	İSOTEM	İHSAN MUTLU	0378 227 18 28	0378 227 18 28	0542 324 50 97
S-030	BATMAN	GLOBAL TİC.	MEHMET DURMAZ	0488 212 88 75	0488 214 16 39	0535 669 38 94
S-031	BATMAN	FURKAN TEKNİK	BEKİR AKTAŞ	0488 215 72 74	0488 215 72 74	0533 358 04 86
S-032	BAYBURT-GÜMÜŞHANE	GLOBAL TEKNİK	ZEKİ KAVALI	-	-	0530 475 21 90
S-033	BİNGÖL	PINAR SOĞUTMA	MUHAMMET PINAR	0426 214 11 91	0426 214 11 91	0543 592 85 20
S-034	BİTLİS	CİNOĞLU SOĞUTMA	CEVDET CİNOĞLU	0434 828 02 28	0434 226 64 73	0537 685 76 92
S-035	BOLU	İKLİM SOĞUTMA	ERGÜN RÜZGAR	0374 212 23 32	0374 212 12 32	0532 635 05 52
S-036	BURSA	TEKNO-TEM	ALİ EKBER ÖZGÜNAL	0224 256 73 53	0224 256 73 55	0537 383 35 04
S-037	BURSA	TİPİ TEKNİK	ALPER KOCA	0224 361 04 39	0224 362 77 33	0532 792 34 84
S-038	BURSA	İDEAL SOĞUTMA	ŞAKİR ERDEN	0224 272 17 82	0224 272 17 82	0538 570 77 93
S-039	BURSA	ÖZ TEKNİK	HALİL ÖZDEMİR	0224 215 00 68	0024 215 00 48	0532 724 25 68
S-040	BURDUR	CEYLAN SOĞUTMA	MUHAMMET CEYLAN	0248 233 77 03	-	0544 646 65 46
S-041	ÇANAKKALE	SEVİNÇ TEKNİK	HALİL SEVİNÇ	0286 217 36 99	0286 217 36 99	0542 838 88 98
S-042	ÇANKIRI	AKBIYIK TEKNİK	BURAK AKBIYIK	0376 213 42 56	0376 213 42 56	0542 313 50 87
S-043	ÇORUM	AKGÜL SOĞUTMA	CAFER AKGÜL	0364 224 40 44	0364 224 40 44	0532 275 08 79
S-044	DENİZLİ	TUĞBA TİCARET	ASLAN BEY	0258 263 47 60	0258 263 47 60	0549 549 11 56
S-045	DENİZLİ	CENGİZ SOĞUTMA	CENGİZ CEYLAN	0258 211 70 37	0258 212 43 35	0542 251 79 19
S-046	DENİZLİ	KUZEY END.MUT.	KEMAL BARIŞ	0258 263 03 41	-	0555 027 8787
S-047	DIYARBAKIR	AS TEKNİK	AHMET MUMCU	0412 215 51 59	0412 215 51 59	0534 460 09 18
S-048	DIYARBAKIR	ÖZ SOĞUTMA	ORHAN ÖZCEYLAN	0412 238 00 13	0412 238 00 13	0532 548 34 71
S-049	EDİRNE	GÖKAY TİC.	GÖKAN GÖKAY	0284 213 55 22	0284 213 55 22	0538 749 66 66
S-050	EDİRNE-KEŞAN	BURSALI MAK.	HASAN BURSALI	0284 715 30 27	0284 715 30 27	0532 623 34 87

Teknik Servis Listesi

Technical Service List

S.Kodu	Bölge	Yetkili Servis	İsim	Telefon	Fax	Cep
S-051	ELAZIĞ	NEKA TEKNİK	NECİP KAÇAR	0424 218 28 27	0424 218 28 27	0535 516 48 23
S-052	ELAZIĞ	AKADEMİ SOĞUTMA	ERKAN KUZU	0424 236 42 40	-	0536 616 24 97
S-053	ERZİNCAN	ARİSTON	METE DEMİREL	0446 214 16 33	0446 223 83 85	0532 748 55 61
S-054	ERZURUM	REF TURİZM END.	FATİH TURGUTOĞLU	0442 235 17 77	-	0536 962 95 62
S-055	ESKİŞEHİR	ELİT TEKNİK	TANER YARDIM	0222 231 10 04	-	0535 429 37 98
S-056	ESKİŞEHİR	NİSA TEKNİK	UĞUR KÖREL	0222 220 76 90	-	0554 526 11 26
S-057	G.ANTEP	YILDIZ SOĞUTMA	MUSTAFA SAKALLI	0342 325 37 00	0342 323 71 24	0535 443 21 98
S-058	G.ANTEP	TEKNİK KİMYA	ALİ AKTOP	0342 323 24 35	0342 323 24 35	0533 934 68 10
S-059	G.ANTEP	TAŞKAR SOĞUTMA	İSMAİL TAŞ	0342 322 41 42	-	0532 542 78 43
S-060	G.ANTEP	ALP SOĞUTMA	ASEF ALPDOĞAN	0342 232 91 94	-	0535 566 10 99
S-061	GİRESUN	KADER SOĞUTMA	KADER TEKE	0454 216 19 23	0454 216 19 23	0536 841 14 79
S-062	HAKKARİ-YÜKSEKOVA	ÖZLEM SOĞUTMA	NİHAT GEÇİRGEN	0438 351 20 29	0438 351 82 06	0544 351 20 29
S-063	HATAY	ÇAĞ TEKNİK	HÜSEYİN BAYRAKTAR	0326 223 14 15	0326 223 14 15	0532 635 77 91
S-064	HATAY	ÜMRAN SOĞUTMA	SEMİR DEMİRCİ	0326 213 16 96	0326 213 16 96	0533 088 16 77
S-065	HATAY-İSKENDERUN	ARDON SOĞUTMA	HİDAYET KURTUL	0326 617 59 38	0326 613 08 25	0532 570 63 99
S-066	HATAY-İSKENDERUN	İKİLİ TEKNİK	AHMET BOZKURT	0236 615 58 15	-	0554 555 05 38
S-067	İĞDIR	GÜVEN TEKNİK	VAHİT GÜREL	0476 227 16 56	0476 227 16 56	0535 227 22 22
S-068	İSTANBUL-KÜÇÜKÇEKMECE	ALFA TEKNİK	TURGAY YAVUZ	0212 678 70 01	0212 678 70 01	0532 523 93 61
S-069	İSTANBUL-AVCILAR	ENG İNOKS	EMRE DERELİOĞLU	0212 695 42 46	0212 695 42 47	0537 577 65 01
S-070	İSTANBUL-KASIMPAŞA	KARMA TEKNİK	DURAN KARATAY	0212 235 04 11	0212 361 71 87	0532 264 11 72
S-071	İSTANBUL-ATAŞEHİR	AKASYA END.	ZAFER ALADAĞ	0216 527 88 16	-	0544 731 81 36
S-072	İSTANBUL-ATAŞEHİR	GÜVEN END.	KENAN TEYMUR	0216 577 00 67	0216 577 00 69	0532 457 4203
S-073	İSTANBUL-KARTAL	ANADOLU END.	CİHAT BAĞLAMA	0216 377 22 33	0216 377 22 30	0532 599 76 20
S-074	İSTANBUL-BEYOĞLU	ÖRNEK TEKNİK	ÜMİT TOSUN	0535 321 93 89	-	0535 321 93 89
S-075	İSTANBUL-KASIMPAŞA	SER-GAZ SAN.	RIFAT ALTINAY	0212 253 70 14	0212 250 12 04	0536 212 23 27

Teknik Servis Listesi

Technical Service List

S.Kodu	Bölge	Yetkili Servis	İsim	Telefon	Fax	Cep
S-076	İSTANBUL-SULTANBEYLİ	AB TEKNİK	AYDIN TAŞ	0216 398 97 60	0216 398 59 94	0532 656 72 33
S-077	İSTANBUL -KAĞITHANE	MEFF TECH END.	MUSTAFA KARADENİZ	0212 294 00 70	0212 294 00 69	0532 264 11 72
S-078	İSTANBUL-EYÜP	DÜNYA ELEKTRONİK	FATİH TURGUTOĞU	0212 261 13 01	-	0530 390 25 00
S-079	ISPARTA	MUTLU SOĞUTMA	MUSTAN BÜLBÜL	0246 218 19 97	-	0533 556 92 93
S-080	ISPARTA	ORJİNAL SOĞUTMA	YUSUF ACET	0246 218 81 80	-	0535 739 04 85
S-081	İZMİR	FROZEN TEKNİK	DAVUT KEKLİKSOY	0535 506 22 98	-	0535 506 22 98
S-082	İZMİR	AYBARS TEKNİK	SEÇKİN ŞENAL	-	-	0535 401 97 90
S-083	İZMİR	DELTA TEKNİK	SEDAT TALAY	0232 426 41 94	0232 426 41 94	0532 333 73 19
S-084	İZMİR	ÖNCÜL SERV.	HALİL ŞEN	0232 442 18 66	0232 440 00 68	0533 358 10 58
S-085	İZMİR	SETEN MAK.	ERHAN GÖKOĞLU	0232 347 12 63	0232 462 81 67	0530 306 54 69
S-086	İZMİR	EGE TEKNİK	UFKAN ŞENAL	0232 264 93 61	-	0533 306 68 50
S-087	İZMİR	BAYER TEKNİK	M.YUNUS SEZGİNLER	-	-	0507 343 01 09
S-088	İZMİR	SERVİCE 35	METİN GÖRGÜN	-	-	0546 419 0301
S-089	K.MARAŞ	KOZANOĞLU BOBİNAJ	MUSTAFA TEPEBAŞILI	0344 236 18 98	0344 236 18 98	0542 207 81 67
S-090	K.MARAŞ	ÖZGÜR SOĞUTMA	ŞAHİN BÜYÜKMEHMET	0344 231 44 10	0344 231 02 35	0542 423 20 84
S-091	K.MARAŞ-ELBİSTAN	ZEDELİ SOĞUTMA	MEHMET ZEDELİ	0344 415 01 57	0344 415 38 73	0542 540 03 38
S-092	KARABÜK	KARABÜK TEKNİK	MUSTAFA KABARAN	0370 413 11 95	0370 413 11 95	0535 779 47 64
S-093	KARABÜK	DEĞİŞİM ELEKTRİK	AHMET DEDELER	0366 214 91 91	-	0544 748 64 37
S-094	KARAMAN	ÖZ SOĞUTMA	MUSTAFA ÖZTÜRK	0338 212 06 74	0338 212 91 62	0507 241 32 20
S-095	KARAMAN	ÖZ-AS SOĞUTMA	MEHMET SOYSAL	-	-	0542 743 07 18
S-096	KARS-ARDAHAN	YAVUZ SOĞUTMA	ALİ YAVUZ	0474 223 80 39	0474 212 39 41	0533 339 13 91
S-097	KASTAMONU	KMS EV ALETLERİ	KENAN ALTAN	0366 214 09 89	0366 214 09 89	0543 285 37 30
S-098	KAYSERİ	KOÇLAR TİCARET	YIMAZ KOÇLAR	0352 236 18 41	0352 236 18 53	0507 260 42 28
S-099	KIRIKKALE	IŞIK SOĞUTMA	MUSTAFA IŞIK	0318 225 25 00	0318 225 25 00	0546 421 28 10
S-100	KIRKLARELİ	MUTLU ISITMA SOĞUTMA	MUTLU KONAT	0288 214 67 66	0288 214 67 66	0542 526 58 17

Teknik Servis Listesi

Technical Service List

S.Kodu	Bölge	Yetkili Servis	İsim	Telefon	Fax	Cep
S-101	KIRŞEHİR	BARLAS SOĞUTMA	ŞEVKİ BARLAS	0386 212 31 56	0386 212 31 56	0532 625 28 80
S-102	KOCAELİ	İDEAL TEKNİK	SELAMİ SARIKAYA	0262 321 32 02	-	0532 260 73 26
S-103	KONYA	PEHLİVAN END.	HASAN DUMAN	0332 322 18 88	0332 322 18 81	0533 204 18 19
S-104	KONYA	TMR END.	TAMER ERVURAL	0332 322 70 03	-	0533 816 88 22
S-105	KONYA	FCA GASTRO	FEVZİ SÖĞÜTLÜ	-	-	0532 470 5019
S-106	KONYA-EREĞLİ	CAN BOBİNAJ	HÜSEYİN ÖZLÜ	0332 713 83 98	0332 713 83 98	0533 372 61 50
S-107	KÜTAHYA	ASİL TEKNİK	KERİM KARACA	0274 216 19 73	0274 216 19 73	0537 973 28 73
S-108	MALATYA	KUTUPLAR SOĞUTMA	YUSUF SARIGÜL	-	-	0532 206 29 09
S-109	MALATYA	BEKA TEKNİK	KASIM DURMUŞ	0422 325 10 89	-	0534 981 43 43
S-110	MARDİN	MUM TEKNİK	CÜNEYT MUMCU	0482 213 32 82	-	0532 392 92 29
S-111	MANİSA	AKSOY ELKTRİK	FARUK AKSOY	-	-	0536 237 17 97
S-112	MERSİN	BALKAN SOĞUTMA	BALKAN ÖLÇÜCÜ	0324 336 24 11	0324 336 24 11	0535 723 94 26
S-113	MERSİN	DEMİR TİC.	DURŞUN DEMİR	0324 231 25 22	0324 231 25 22	0532 352 68 74
S-114	MERSİN	CHEFS END.MUT.	SERKAN BEY	0324 408 55 46	-	0539 688 8668
S-115	MERSİN-ANAMUR	ANAMUR SOĞUTMA	MUSTAFA YILMAZ	0324 814 34 88	0324 814 34 88	0541 874 79 40
S-116	MUĞLA-BODRUM	CANAY TEKNİK	CEMİL RAMİTGAN	0252 313 67 47	-	0532 274 63 57
S-117	MUĞLA-BODRUM	EMİR TEKNİK	ABDÜLMETİN TANSEL	0252 363 00 67	0252 363 00 67	0532 668 34 83
S-118	MUĞLA-BODRUM	ONUR TEKNİK	OKAN SOYAKER	-	-	0543 342 3539
S-119	MUĞLA-DATÇA	DATÇA SOĞUTMA	MUSTAFA ARSLAN	0554 686 21 11	-	0554 686 21 11
S-120	MUĞLA-FETHİYE	TEKNOSER END.	EKREM CANPOLAT	0252 612 50 62	0252 614 90 65	0537 338 68 34
S-121	MUĞLA-FETHİYE	BURAK TEKNİK	MUSA KAPLAN	0252 614 00 31	0252 614 00 31	0536 665 80 47
S-122	MUĞLA-MARMARİS	ATA BOBİNAJ	YUNUS ÜNAL	0252 412 19 48	0252 412 19 48	0532 502 17 67
S-123	MUĞLA-MARMARİS	KAAN TEKNİK	AHMET BOSTANCI	0252 412 20 37	0252 412 20 38	0533 720 02 91
S-124	SİVAS	ADA PANEL	CELİL OKAN GÜRSELİ	-	-	0544 787 85 58
S-125	MUŞ	BEYAZ SERV.	CEVDET AKSOY	0436 212 29 96	0436 212 29 96	0542 831 55 96

Teknik Servis Listesi

Technical Service List

S.Kodu	Bölge	Yetkili Servis	İsim	Telefon	Fax	Cep
S-126	MUŞ	GÜNAY SOĞUTMA	KADİR GÜNAY	0436 212 26 89	0436 212 18 39	0541 784 64 35
S-127	NEVŞEHİR	ALSTAR SOĞUTMA	CİHAT KOYUTÜRK	0384 214 17 26	0384 212 85 51	0532 436 43 21
S-128	NİĞDE	ARI SOĞUTMA	İSMAİL ARISOY	0388 213 32 78	0388 213 34 84	0532 706 56 26
S-129	ORDU	ÖZEN SOĞUTMA	MEHMET ÖZEN	0452 212 30 42	0452 212 30 42	0532 336 76 23
S-130	ORDU	KADER SOĞUTMA	KADER TEKE	0454 216 19 23	0454 216 19 23	0536 841 14 79
S-131	OSMANİYE	GÜRÜNLÜOĞLU	RAMAZAN KARAPINAR	0328 826 09 84	0328 826 09 84	0542 508 32 12
S-132	RİZE-ARTVİN	TR İNOX	İSMAİL KAN	0464 213 33 25	-	0546 464 53 02
S-133	SAKARYA-ADAPAZARI	MERKEZ TEKNİK	İSMAİL ÇEVİK	0264 282 00 33	0264 282 00 82	0530 242 09 30
S-134	SAMSUN	SAKA END.	MEHMET SAKA	0362 234 03 33	-	0536 711 49 30
S-135	SAMSUN	TEMSAN	AHMET UYGUR	-	-	0532 214 82 85
S-136	SIİRT	TANER SOĞUTMA	MEHMET TÜRKOĞLU	0484 224 61 41	0484 224 61 41	0544 224 61 41
S-137	ŞANLIURFA	ÇULLU TEKNİK	HASAN ÇULLU	0414 215 44 39	0414 215 15 09	0542 517 91 49
S-138	ŞIRNAK	KAR SOĞUTMA	FAİK UYSAL	0486 216 77 20	0486 216 77 20	0543 611 77 20
S-139	ŞIRNAK	GÜVEN TEKNİK	MEHMET KADRI	0486 216 74 29	0486 216 74 29	0542 429 39 49
S-140	TEKİRDAĞ-ÇORLU	ÖREN TEKNİK	HASAN ÖREN	0282 653 28 66	0282 651 73 82	0555 827 73 72
S-141	TOKAT	GÜNEY TEKNİK	DURAN AKTAŞ	0356 214 55 95	0356 214 55 95	0505 235 65 72
S-142	TRABZON	ÖZİNOKS END.MUT.	YAŞAR AKPINAR	0462 323 23 40	-	0530 368 4708
S-143	TUNCELİ	TURAN TEKNİK	İSMAİL TURAN	0428 212 35 47	0428 212 35 47	0532 495 32 67
S-144	UŞAK	KARAGÖZ TEKNİK	GÖKSEL KARAGÖZ	0276 224 46 35	0276 224 46 35	0536 230 71 41
S-145	VAN	ALPAY TEKNİK	ÖMER ALPAY	0432 215 77 17	0432 215 77 17	0539 313 43 89
S-146	YALOVA	DOĞAN TEKNİK	ORHAN DOĞAN	0226 461 23 41	0226 461 23 41	0553 383 27 30
S-147	YOZGAT-SORGUN	ÇAĞDAŞ ELEKT.	RAMAZAN TATAROĞLU	0354 415 83 92	0354 415 83 92	0535 426 47 05
S-148	ZONGULDAK	GÜNAYDIN TEKNİK	İSMAİL GÜNAYDIN	0372 222 02 23	0372 222 02 23	0541 741 00 67
S-149	ZONGULDAK-EREĞLİ	AY YILDIZ TEKNİK	BİROL AYYILDIZ	-	-	0535 568 45 80
S-150	K.K.T.C.-GİRNE	ÖZERTEK END.	ERKAN ÖZBEK	-	-	0533 842 80 81
S-151	K.K.T.C.-GİRNE	SİLVER QUEEN END.	HAKAN ŞAHİN	0392 444 0 454	-	-



İLETİŞİM

Contact

EMPERO Endüstriyel Mutfak Ekipmanları Pazarlama İç ve Dış Tic. A.Ş.

Fabrika / Factory

Konya Organize Sanayi Bölgesi
Büyük Kayacık Mah. 9.Sokak No:20
42050 Selçuklu - KONYA / TÜRKİYE

Tel : 0090 444 15 60
Faks : 0090 332 239 12 11

Gsm : 0090 533 658 94 54
: 0090 530 875 40 86

e-mail : empero@empero.com.tr

Showroom

Topçular Mah. Ferhatpaşa Cad. No:4/F
Eyüp / İSTANBUL / TÜRKİYE

Tel : 0090 212 361 83 00 (pbx)
Faks : 0090 212 361 83 03

e-mail : istanbul@empero.com.tr

www.empero.com.tr

Saęlık için her yerde !

Everywhere for health !

MEDTRAY Yemek Daęıtım Arabaları
MEDTRAY Distribution of Meal Trays



EMP.MED.TRY.30
Yemek Daęıtım Arabası
Distribution of Meal Tray

EMP.MED.TRY.30
Yemek Daęıtım Arabası
Distribution of Meal Tray



G|R|O|U|P

İş'in Mutfaęı / Kitchen of Business



Endüstriyel Mutfak Ekipmanları Pazarlama İç ve Dış Ticaret A.Ş.
Industrial Kitchen Equipment Marketing Import & Export Trade Co.

www.empero.com.tr