

# robot coupe®

Version "C"

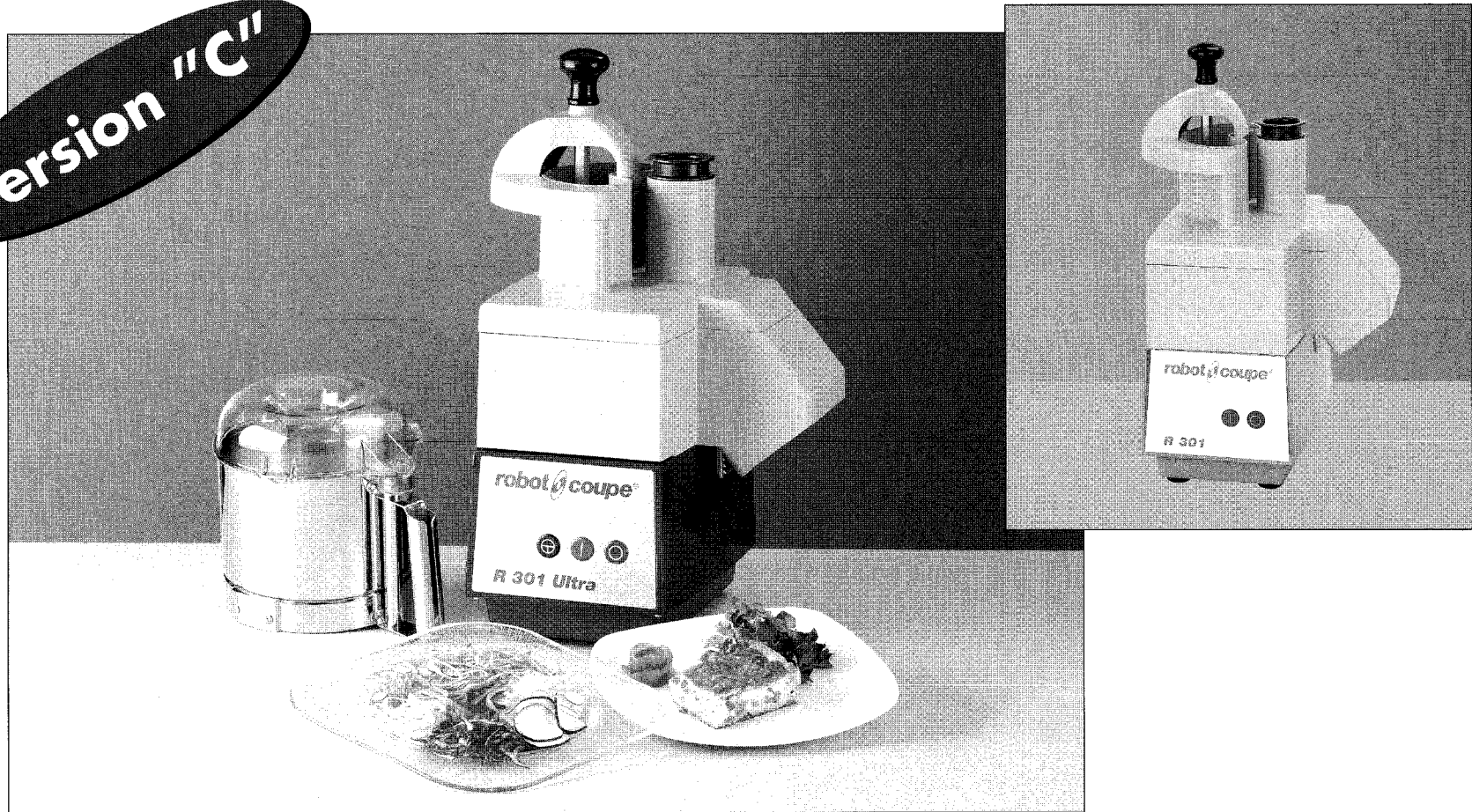

**R301 • R301 Ultra**

# SUMMARY

## WARRANTY

## IMPORTANT WARNING

## INTRODUCTION TO YOUR NEW R301/R301 Ultra BOWL CUTTER/VEGETABLE PREPARATION "C" VERSION

## SWITCHING ON THE MACHINE

- Advice on electrical connections
- Control panel

## ASSEMBLY

- Bowl cutter attachment
- Citrus-press attachment
- Vegetable preparation attachment

## USE EXAMPLES

- Bowl cutter attachment
- Vegetable preparation attachment

## OPTIONS

- Serrated blade
- Slightly serrated blade
- Citrus-press

## CLEANING

- Motor base
- Bowl cutter attachment
- Citrus-press attachment
- Vegetable preparation attachment
- Blade

## MAINTENANCE

- Blade
- Motor seal
- Bowl locating plates

## TECHNICAL SPECIFICATIONS

- Weight
- Dimensions
- Working height
- Noise level
- Electrical data

## SAFETY

## STANDARDS

## TECHNICAL DATA (Page 59)

- Exploded views
- Electrical and wiring diagrams

# ROBOT-COUCPE S.N.C., LIMITED WARRANTY

Your new ROBOT-COUCPE appliance is warranted to the original buyer for a period of one year from the date of sale if you bought it from ROBOT-COUCPE S.N.C.

If you bought your ROBOT-COUCPE product from a distributor your product is covered by your distributor's warranty (Please check with your distributor terms and conditions of the warranty).

The ROBOT-COUCPE S.N.C. limited warranty is against defects in material and/or workmanship.

## THE FOLLOWING ARE NOT COVERED BY THE ROBOT-COUCPE S.N.C. WARRANTY:

**1** - Damage caused by abuse, misuse, dropping, or other similar damage caused by or resulting from failure to follow assembly, operating, cleaning, user maintenance or storage instructions.

**2** - Labour to sharpen and/ or replacements for blades which have become blunt, chipped or worn after a normal or excessive period of use.

**3** - Materials or labour to replace or repair scratched, stained, chipped, pitted, dented or discoloured surfaces, blades, knives, attachments or accessories.

**4** - Any alteration, addition or repair that has not been carried out by the company or an approved service agency.

**5** - Transportation of the appliance to or from an approved service agency.

**6** - Labour charges to install or test new attachments or accessories (i.e., bowls, discs, blades, attachments) which have been arbitrarily replaced.

**7** - The cost of changing direction-of-rotation of three-phase electric motors (Installer is responsible).

**8** - SHIPPING DAMAGES. Visible and latent defects are the responsibility of the freight carrier. The consignee must inform the carrier and consignee immediately, or upon discovery in the case of latent defects.

KEEP ALL ORIGINAL CONTAINERS AND PACKING MATERIALS FOR CARRIER INSPECTION.

Neither ROBOT-COUCPE S.N.C. nor its affiliated companies or any of its distributors, directors, agents, employees, or insurers will be liable for indirect damage, losses, or expenses linked to the appliance or the inability to use it.

The ROBOT-COUCPE S.N.C. warranty is given expressly and in lieu of all other warranties, expressed or implied, for merchantability and for fitness toward a particular purpose and constitutes the only warranty made by ROBOT-COUCPE S.N.C. France.

# IMPORTANT WARNING



**WARNING:** In order to limit accidents such as electric shocks, personal injury or fire, and in order to limit material damage due to misuse of the appliance, please read these instructions carefully and follow them strictly. Reading the operating instructions will help you get to know your appliance and enable you to use the equipment correctly. Please read these instructions in their entirety and make sure that anyone else who may use the machine also reads them beforehand.

## UNPACKING

- Carefully remove the equipment from the packaging and take out all the boxes or packets containing attachments or specific items.
- **WARNING** - some of the tools are very sharp e.g. blade, discs... etc.

## INSTALLATION

- We recommend you to install your machine on a perfectly stable solid base.

## CONNECTION

- Always check that your mains supply corresponds to that indicated on the rating plate on the motor unit and that it can take the amperage.
- The machine must be earthed.

## HANDLING

- Always take care when handling the blades or discs - they are very sharp.

## ASSEMBLY PROCEDURES

- Follow the various assembly procedures carefully (see page 14) and make sure that all the attachments are correctly positioned.

## USE

- Never try to override the locking and safety systems.
- Never introduce any object into the container where the food is being processed.
- Never push the ingredients down with your hand.
- Do not overload the appliance.
- Never switch the appliance on while it is empty.

## CLEANING

- As a precaution, always unplug your appliance before cleaning it.
- Always clean the appliance and its attachments at the end of each cycle.
- Never place the motor unit in water.
- For parts made of aluminum alloys, use cleaning fluids suitable for aluminum.

- For plastic parts, do not use detergents that are too alkaline (i.e., containing too much caustic soda or ammonia...)
- Robot-Coupe can in no way be held responsible for the user's failure to follow the basic rules of cleaning and hygiene.

## MAINTENANCE

- Before opening the motor housing, it is absolutely vital to unplug the appliance.
- Check the seals and washers regularly and ensure that the safety devices are in good working order.
- It is particularly important to maintain and check the attachments since certain ingredients contain corrosive agents e.g. citric acid.
- Never operate the appliance if the power cord or plug has been damaged in any way or if the appliance fails to work properly or has been damaged in any way.
- Do not hesitate to contact your local Maintenance Department if something appears to be wrong.

## INTRODUCTION TO YOUR NEW R301/R301 Ultra BOWL CUTTER/VEGETABLE PREPARATION ATTACHMENT "C" VERSION

The R301/R301 Ultra is perfectly geared to professional needs. It can perform any number of tasks, which you will gradually discover as you use it.

This food processor consists of a bowl cutter and vegetable preparation attachment. In cutter mode, (3,5 litres stainless steel bowl for the R301 Ultra model and 3,5 litres bowl made in ABS for the R301 model), it can be used to process meat, vegetables, fine stuffing, mousse, grinding, kneading,... in less than 5 minutes for even the longest tasks. In the vegetable preparation version, the device has a wide range of discs for thin slicing, grating and julienne vegetables.

As an option for this combined unit, a citrus-press attachment can also be used.

Its numerous functions will open the door to a whole new culinary world.

Thanks to its simple design, all components requiring frequent handling for maintenance or cleaning can be fitted and removed in a trice.

To make things easier for you, this manual gives a breakdown of all the various fitting operations.

This manual contains important information designed to help the user get the most out of his or her R301/R301 Ultra bowl cutter/vegetable preparation device.

**We therefore recommend that you read it carefully before using your machine.** We have also included a few examples to help you get the feel of your new machine and appreciate its numerous advantages.

## SWITCHING ON THE MACHINE

### • ADVICE ON ELECTRICAL CONNECTIONS

Before plugging in, check that your power supply corresponds to that indicated on the machine's identification plate.

The R301/R301 Ultra are fitted with various types of motors :

- 230 V / 50 Hz / 1
- 115 V / 60 Hz / 1
- 220 V / 60 Hz / 1

The machine comes with a single phase plug connected to a power cord.

**! WARNING**

**This appliance must be plugged into an earthed socket (risk of electrocution).**

### • CONTROL PANEL

#### R301 Ultra

Red switch = Off switch  
Green switch = On switch  
Black switch = Pulse control

#### R301

Red switch = Off switch  
Green switch = On switch

## ASSEMBLY

### • CUTTER BOWL ATTACHMENT

1) With the motor base facing you, make sure that the bowl is straight in relation to the motorshaft, with the magnetic bar moved slightly to the left.

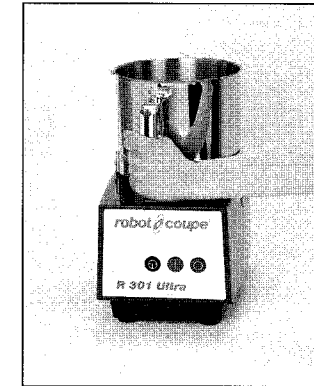
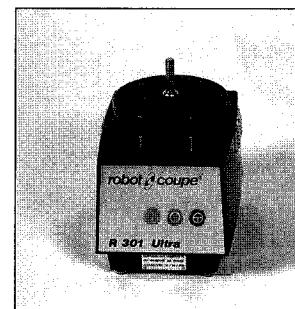

2) Turn the bowl to the right until the motor base connectors are securely positioned in their sockets. The magnetic rod should now be straight in front of you, in contact with the front of the motor base.

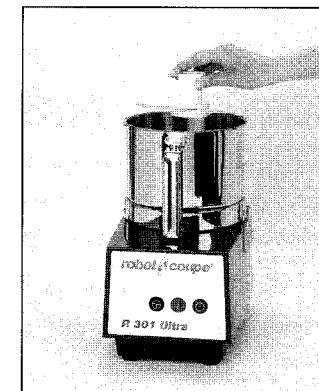

3) Engage the blade on the motor shaft and lower it right to the bottom of the bowl. Make sure that it is correctly positioned, by rotating it in the bowl.

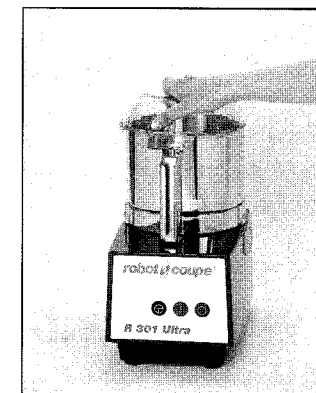

4) Place the lid on the bowl and rotate to the right until it clicks. You will notice that the magnet on the lid is directly above the magnetic bar.

The device is now ready for use.

• **CITRUS-PRESS ATTACHMENT**

1) and 2) Operate the same way for the cutter attachment.

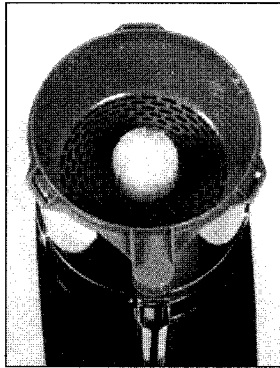

3) Place the basket on the bowl and rotate until it clicks. You will notice that the magnet of the basket is directly above the magnetic bar.

4) Engage the cone on the motor shaft and lower it right to the bottom of the bowl.

5) Switch on the machine, then keep the fruit on the cone until the juice is completely extracted from the fruit. Stop the machine when finished.

Stop the machine when finished.

• **VEGETABLE PREPARATION ATTACHMENT**

The vegetable preparation attachment consists of two detachable parts: the vegetable preparation bowl and the lid.

1) With the motor base facing you, fit the bowl onto the motor base; the ejection chute should be on your right.

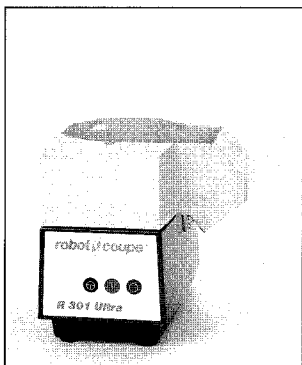
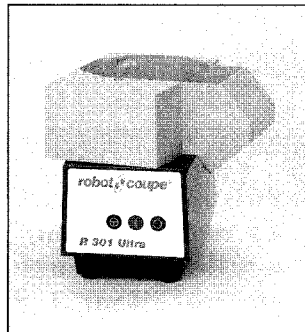

2) Turn the bowl to the right until the motor base connectors are securely positioned in their sockets.

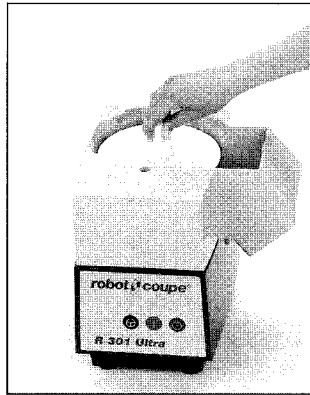

4) Then choose the disc to be set onto the ejecting plate.

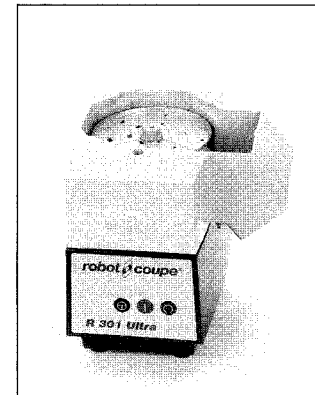

5) Place the lid on the bowl and rotate to the right until the lid clicks, to form an extension of the bowl.

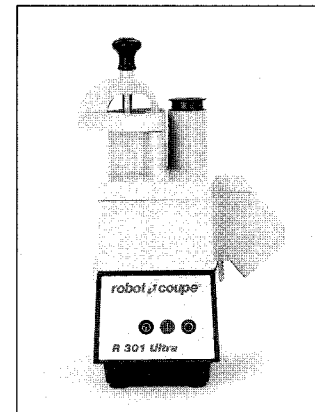
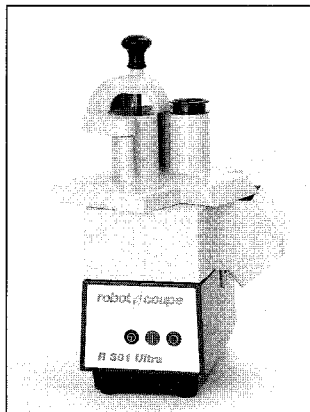

3) Engage the white plastic ejecting plate on the motorshaft and check that it is properly positioned at the bottom of the bowl.

**USE EXAMPLES**

• **BOWL CUTTER ATTACHMENT**

The cutter will enable you to perform all your cutting tasks in minimum time; we recommend therefore, that you keep a close eye on the mixture in order to obtain the desired results.

The pulse control allows you to stop and start the machine for high-precision control when working with certain types of ingredients.

The cutter version has numerous other applications. The above quantities and times are approximate and may vary according to the quality of the ingredients and recipes.

| USES                          | Max. processing quantity (in kg) | Processing time (in mn) |
|-------------------------------|----------------------------------|-------------------------|
| <b>CHOP</b>                   |                                  |                         |
| • <b>MEAT</b>                 |                                  |                         |
| Hamburgers/steak tartare      | 0.8                              | 3                       |
| Sausage meat/tomatoes         | 1                                | 3                       |
| Terrine/pâté                  | 1                                | 4                       |
| • <b>FISH</b>                 |                                  |                         |
| Brandade                      | 1                                | 5                       |
| Terrines                      | 1                                | 5                       |
| • <b>VEGETABLES</b>           |                                  |                         |
| Garlic/parsley/onion/shallots | 0.2 / 0.5                        | 3                       |
| Soup / purées                 | 1                                | 4                       |
| • <b>FRUIT</b>                |                                  |                         |
| Compotes / purées             | 1                                | 4                       |

| EMULSIFY                             |     |   |
|--------------------------------------|-----|---|
| Mayonnaise / aïoli / remoulade sauce | 1   | 3 |
| Hollandaise/béarnaise                | 1   | 5 |
| Snail or salmon butter               | 1   | 4 |
| KNEAD                                |     |   |
| Shortcrust pastry/shortbread         | 2   | 4 |
| Flaky pastry                         | 2   | 4 |
| Pizza dough                          | 2   | 4 |
| GRIND                                |     |   |
| Dried fruit                          | 0.5 | 4 |
| Ice                                  | 0.5 | 4 |
| Breadcrumbs                          | 0.5 | 4 |

### • VEGETABLE PREPARATION ATTACHMENT

The vegetable preparation attachment consists of two hoppers:

- one large hopper for cutting vegetables such as cabbage, celeriac, etc.
- a cylindrical hopper for long vegetables and high-precision cutting.

For optimum cutting, use this section as a guide.

### HOW TO USE THE LARGE HOPPER

- Raise the lever and release the hopper opening.
- Fill hopper with vegetables.
- Replace the lever at the base of the hopper.
- Start to press the lever, switch on the machine and maintain pressure until there are no vegetables left in the hopper.

### HOW TO USE THE CYLINDRICAL HOPPER

- Fill hopper with vegetables.
- Start to press the button and switch on the machine.
- Maintain pressure until all the vegetables have been processed.

| SLICERS           |   |
|-------------------|---|
| S1                | carrot / cabbage / cucumber / onion / potato / leek   |
| S2/S3             | lemon / carrot / mushroom / cabbage / potato / cucumber / zucchini / onion / leek / bell pepper               |
| S4/S5             | eggplant / beet root / carrot / mushroom / cucumber / bell pepper / radish / lettuce / potato / leek / tomato |
| S6                | eggplant / beet root / carrot / mushroom / cucumber / bell pepper / radish / lettuce / potato / leek          |
| RIPPLE CUT SLICER |   |
| S2                | beet root / potato  |
| GRATERS           |   |
| G1,5              | celeriac / cheese   |
| G2                | carrot / celeriac / cheese  |
| G3                | carrot  |
| G6                | cabbage / cheese  |
| G9                | cabbage / cheese  |
|                   | Parmesan / chocolate  |
|                   | Radish 0.7 mm   |
|                   | Radish 1 mm   |
| JULIENNE          |   |
| J2x2              | carrot / celeriac / potato  |
| J2x4              | carrot / beet root / zucchini / potato  |
| J2x6              | carrot / beet root / zucchini / potato  |
| J4x4              | eggplant / beet root / zucchini / potato  |
| J6x6              | eggplant / beet root / celeriac / zucchini / potato   |
| J8x8              | celeriac / potato   |

### OPTIONS

- A **serrated blade** is available as an option and is mainly intended for kneading and grinding.

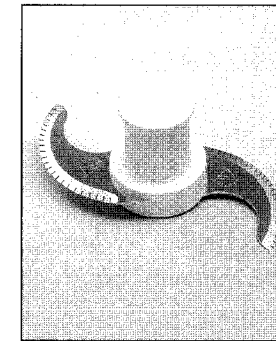
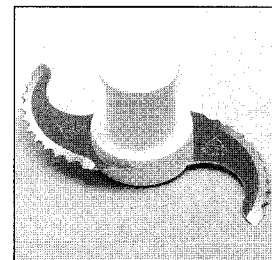

- A **slightly serrated blade** is also available. This blade has the same function as a straight blade. It has been conceived for a longer lasting cut performance but with no sharpening possibility. We advise you to use this blade mainly to chop parsley.

- **The citrus-press** extracts the juice of oranges, lemons, grapefruits and others it consists of a grey basket and a yellow cone.

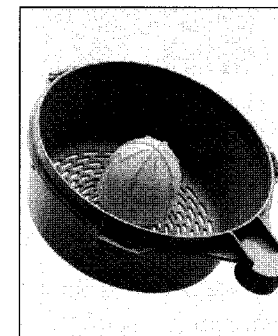

### CLEANING

**⚠ WARNING**

As a precaution, always unplug your appliance before cleaning it (risk of electrocution).

- **MOTOR BASE**  
Never immerse the motor base in water. Clean using a damp cloth or sponge.
- **BOWL CUTTER ATTACHMENT**  
After removing the lid, remove the bowl from the motor base by rotating it to the left. Pull up to

disengage, leaving the blade in the bowl in order to prevent any spillage when working with liquids.

If the food has a solid consistency, remove the blade and empty the bowl.

Replace the bowl, place the blade back on the shaft and switch on the machine in order to remove any mixture which may have stuck to the blade.

If you wish, you can rinse the bowl by filling it with hot water and switching on for a few minutes

### • CITRUS-PRESS ATTACHMENT

Disengage the basket with the cone by rotating it clockwise. Then raise them all together. Disengage the bowl as usual. After that, clean each part.

### • VEGETABLE PREPARATION ATTACHMENT

Remove each of the parts, i.e.: the lid, disc, sling plate and bowl and clean.

Diswashers are best avoided. Instead we recommend that you clean the machine by hand, using washing-up liquid.

### • BLADE

After cleaning the blade, always dry the blades well.

**! IMPORTANT**

Check that your detergent is suitable for cleaning plastic parts. Some washing agents are too alkaline (e.g. high levels of caustic soda or ammonia) and totally incompatible with certain types of plastic, causing them to deteriorate rapidly.

## MAINTENANCE

### • BLADE

We strongly recommend that the blades (smooth ones) are sharpened daily using sharpening stone supplied with machine.

The quality of the cut depends mainly on the sharpness of your blades and the degree of wear. The blades are actually wearing parts, which should be replaced occasionally to ensure consistent quality in the final product.

### • MOTOR SEAL

The motor seal protects the motor base and motor from any leaks and needs to be replaced at regular intervals.

### • BOWL LOCATING PLATES (R 301 Ultra)

If these plates wear out, the bowl will no longer be securely attached to the motor base.

This makes it awkward to use since the bowl can come loose during processing.

There is no risk to the user however, because the safety system will automatically stop the machine.

It is advisable therefore to change these plates in order to ensure maximum ease of use.

## TECHNICAL SPECIFICATIONS

### • WEIGHT

|                           | net weight | gross weight |
|---------------------------|------------|--------------|
| R301 (without disc)       | 13 kg      | 16 kg        |
| R301 Ultra (without disc) | 14 kg      | 17 kg        |

### • DIMENSIONS (in mm)

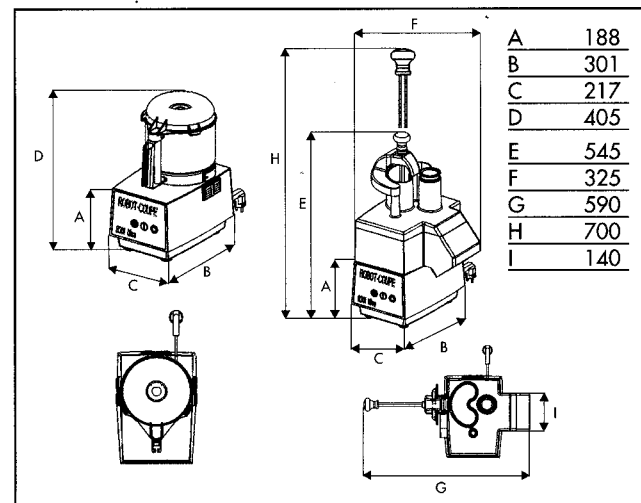

### • WORKING HEIGHT

We recommend that you position the food processor on a stable worktop so that the upper edge of the large feed hopper is at a height of between 1.20 m and 1.30 m.

### • NOISE LEVEL

The equivalent continuous sound level when the food processor is operating on no-load is less than 70 dB(A).

### • ELECTRICAL DATA

single-phase machine

| Motor         | Speed (rpm) | Power (watts) | Intensity (Amp.) |
|---------------|-------------|---------------|------------------|
| 230 V / 50Hz  | 1500        | 650           | 5,7              |
| 115 V / 60 Hz | 1800        | 650           | 12,0             |
| 220 V / 60 Hz | 1800        | 650           | 5,7              |



## SAFETY

The R301/R301 Ultra are fitted with a magnetic safety device and motor braking system.

As soon as you open the cutter lid, the motor stops. To restart the machine, simply close the lid and press the green switch.

As soon as you open the lever of the vegetable preparation attachment, the motor stops. As soon as you close the lever, the machine restarts. Beyond 4 or 5 seconds opening time, simply close the lever and press the green switch.



### WARNING

**The blades and discs are extremely sharp.  
Handle with care.**

In order to avoid splash when processing liquid preparation in the cutter bowl, we recommend you to stop the machine before opening the lid.

The R301 and R301 Ultra are fitted with a **thermal cut-out** which automatically stops the motor if the machine is left on for too long or overloaded.

If this happens, allow the machine to cool completely before restarting.



### REMEMBER

**Never try to override the locking and safety systems.**

**Never introduce any object into the container where the food is being processed.**

**Never push the ingredients down with your hand.**

**Do not overload the appliance.**

**Never switch the appliance on while it is empty.**

## STANDARDS

MACHINES IN COMPLIANCE WITH:

- The following European directives and related national legislation:
  - Modified "machinery" directive 98/37/EEC,
  - "Low voltage" directive 73/23/EEC,
  - "EMC" directive 89/336/EEC,
  - "Materials and parts in food contact" directive 89/109/EEC,
  - "Plastic materials and parts in food contact" directive 90/128/EEC.
- The following European harmonized standards and standards setting out health and safety rules:
  - EN 292 - 1 and - 2,
  - EN 60204 -1 (1992),
  - For Food Processors and blenders : EN 12852,
  - For Vegetable cutting machine : EN 1678.

INDEXES OF PROTECTION:

- IP 55 for the switches.
- IP 34 for the machines.