



SALAD SPINNER ES-100

Capacity per cycle: 6 Kg. / 10 gal.



DYNAMIC PREPARATION
COMMERCIAL SALAD SPINNERS

SALES DESCRIPTION

Fast, sleek, quiet, user-friendly, safe, smooth running commercial salad spinner, designed to efficiently dry up to 6 Kg. / 10 gal. of salad per cycle at a maximum speed of 900rpm. Portable. Equipped with locking wheels. Cycle memory. 2-speed-appliance.

- ✓ Sammic salad spinners dry lettuce and other vegetables in as low as 1-3 minutes owing to their fast speed (900 r.p.m), ensuring good product quality.
- ✓ Equipped with powerful three-phase motors controlled by highly reliable electronic speed variator, which enables the salad dryer to be connected to a single-phase electrical mains supply.
- ✓ Stainless steel construction.
- ✓ Lightweight and removable stainless steel basket.
- ✓ Compact geometry: easily fits under conventional standard counter-tops.
- ✓ Equipped with castors allowing the operator to wheel unit around the kitchen and under a countertop for easy storage.
- ✓ Transparent, heavy duty lid for ease of control.
- ✓ Lid equipped with a self-opening mechanism, for ease of access to basket.
- ✓ User-friendly, waterproof control panel. Advanced features
- ✓ Electronic timer with 3 fixed cycles.
- ✓ Weight distribution detection system (VCS) to prevent rattling of the unit. Self lock-in mechanism to ensure basket is properly secured before cycle starts.
- ✓ Braking system safety mechanism: allowing basket to stop turning as soon as lid opens.
- ✓ An indicator appears when the door is open.

INCLUDES

- ✓ Castors with brake.
- ✓ Stainless steel drying basket.

OPTIONAL

- Additional stainless steel drying basket.

ACCESSORIES

- Stainless steel basket set

SPECIFICATIONS

Capacity per load: 6 Kg
 Capacity per operation (lettuces): 5-8
 Drainer hourly production: 120 Kg - 360 Kg
 Timer (min-max): 60 " - 120 " - 180 "
 2 speed: (350 rpm - 900 rpm)
 Motor speed: 900 rpm
 Total loading: 550 W

Basket dimensions: 342 mm x 337 mm

External dimensions (WxDxH)

- ✓ Width: 540 mm
- ✓ Depth: 750 mm
- ✓ Height: 665 mm

Net weight: 48 Kg

Crated dimensions

660 x 820 x 860 mm
 Gross weight: 55 Kg

AVAILABLE MODELS

1000700	Salad drier ES-100 230/50-60/1
1000702	Salad drier ES-100 120/50-60/1

* Ask for special versions availability





SALAD SPINNER ES-100

Capacity per cycle: 6 Kg. / 10 gal.



DYNAMIC PREPARATION
COMMERCIAL SALAD SPINNERS

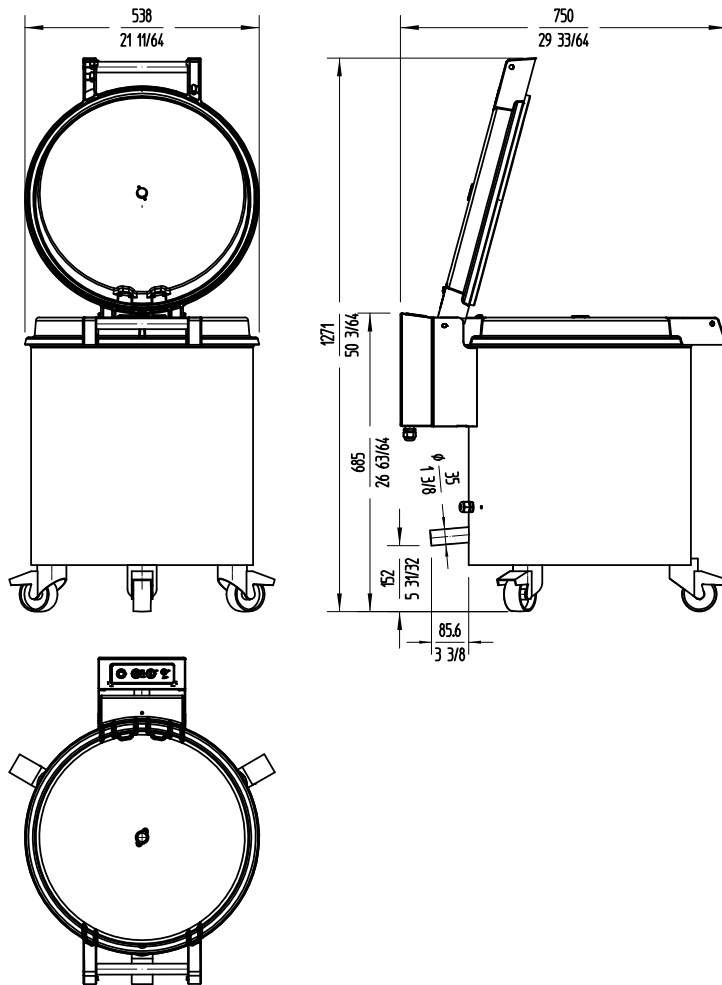

 **sammic** | www.sammic.com
Food Service Equipment Manufacturer

Polígono Basarte, 1. phone +34 943 15 72 36
20720 Azkoitia, Spain sales@sammic.com



Project	Date
Item	Qty
Approved	

product sheet
updated 25/01/2023