



CATALOGO GENERALE GENERAL CATALOGUE

www.famaindustrie.com





CATALOGO GENERALE

GENERAL CATALOGUE

DAL 1953, LA FORZA DELLA TRADIZIONE

THE STRENGTH OF TRADITION SINCE 1953





FAMA INDUSTRIE LA QUALITÀ QUOTIDIANA

THE EVERYDAY LIFE QUALITY



1953 2013

L'esperienza acquisita in sessant'anni di attività si è sviluppata attraverso un cammino progettuale, volto alla produzione di macchine costruite con estrema precisione e con l'utilizzo di materiali di qualità.

FAMA INDUSTRIE è oggi un'Azienda leader nel settore della fabbricazione di attrezzature per Ristorazione, Bar e per la Casa. Per ognuno di questi settori vengono prodotte macchine, altamente qualificate, con accessori studiati appositamente per ogni specifica esigenza.

FAMA INDUSTRIE costruisce macchine all'avanguardia, secondo le normative vigenti, destinate a settori specifici come la Ristorazione. A questo settore appartengono ristoranti, alberghi, comunità, mense, self service, pizzerie; oltre alle varie attività ad esso legate come macellerie, supermercati, salumerie, rosticcerie, take away.

La forza di FAMA INDUSTRIE consiste nel mettere a disposizione della clientela varie tipologie di macchine, diversificate in base all'utilizzo - tritacarne, grattugie, affettatrici, passapomodoro, tagliaverdure, tagliamozzarella - di varie dimensioni e capacità. Queste caratteristiche permettono di scegliere tra una vasta gamma di prodotti, tutti realizzati secondo gli stessi criteri di qualità e affidabilità, ma completamente versatili e adattabili a ogni situazione e ad ogni attività.

Tecnologia e qualità al servizio del lavoro e del vivere quotidiano.

The experience acquired during 60 years of activity has been developed through a design track, dedicated to produce manufacture machines built with extreme precision and with the use of high quality materials. FAMA INDUSTRIES is now a leading company in catering, bar and home appliance equipment manufacturing. Highly professional qualified machines with accessories that are specially designed studied for each need are produced for each of these fields. FAMA INDUSTRIES manufactures modern machines observing norms in force and addressed to specific sectors like catering. Restaurants, hotels, communities, refectories, self services, pizzerias are all part of this sector as well as the different activities linked to them like butcher shops, supermarkets, charcuterie, delicatessen shops, take away. FAMA INDUSTRIE'S strength consists in offering the customers different machine types diversified according to their use - meat grinders, graters, slicers, tomato sauce makers, vegetable cutters, mozzarella cutters - and above all they are supplied in different sizes and capacities. These characteristics allow our customers to choose among a wide range of products, each one made observing the same quality and reliability criteria but extremely versatile and adaptable to any activity. FAMA INDUSTRIES: state-of-the-art-technology designed to improve everyday life.

Certificazioni IMQ

Secondo la Norma / According to Standard
EN 12331 : 2003 + A2 : 2010 (UNI EN 12331 : 2010)

FAMA, al fine di certificare la qualità dei propri macchinari, ha scelto di sottoporli agli scrupolosi esami del più grande istituto Italiano. Un serio e lungo percorso che mira a fornire prodotti di alta qualità, tali da soddisfare la fiducia dei nostri clienti che da sessant'anni hanno scelto la nostra affidabilità. FAMA: la forza della tradizione al passo con i tempi!

FAMA has chosen to certify the quality of its equipment, and for this purpose one of the major Italian laboratory has tested FAMA's products. Thus granting the highest-grade quality products to those customers who have been choosing FAMA, and the reliability of its family run business, for nearly 60 years. FAMA: the strength of tradition that keeps up with times!



Certificato di esame tipo
 Type Examination Certificate

No. IMQ 220

Tritacarne
Mincing machines
 Modelli / Models

TS 12, TI 12, TS 22, TI 22, TSK 22, TIK 22,
 TS 32 ECO, TI 32 ECO, TI 12 R, TI 22 R, TI 32 R



Certificato di esame tipo
 Type Examination Certificate

No. IMQ 221

Tritacarne con grattugia
Mincing machines with grater machines
 Modelli / Models

TG 12, TGI 12, TG 22, TGI 22, TGK 12,
 TGIK 12, TGK 22, TGIK 22



Certificato di esame tipo
 Type Examination Certificate

No. IMQ 222

Tritacarne e tritacarne con grattugia
Mincing machines and mncing machines
with grater machines
 Modelli / Models

TS 8, TI 8, TG 8, TGI 8, GM



Certificato di esame tipo
 Type Examination Certificate

No. IMQ 223

Grattugia
Grater machine
 Modelli / Models

GS, GSD, GSM, GI, GD, GG



Certificato di esame tipo
 Type Examination Certificate

No. IMQ 224

Frullatori e sbattitori portatili
Hand-held blenders and whisks
 Modelli / Models

250VF, 250VV, 300VV, 350VF



Certificato di esame tipo
 Type Examination Certificate

No. IMQ 225

Pelaverdure (pelapatate e puliscicozze)
Vegetable peelers (potatoes peeling
and mussels scraping)
 Modelli / Models

5 Kg, 10 Kg, 18 Kg



CERTIFICATO DI ESAME DI TIPO
TYPE EXAMINATION CERTIFICATE
No. **IMQ 220**

Vostro Conoscitore è un prodotto di ILLUMINATI, in base
alla tecnologia di ILLUMINATI, S.p.A.
INTELLIGENZA (MI) S.p.A. (MILANO)
In base alla tecnologia di ILLUMINATI, S.p.A. (MILANO)

TRITACARNE
Mixing Machine

Marca (Trade mark) **FA**

Modelli / Models **T5 12, T1 12,
T5 32 ECO, T1 32 ECO**

FAMA INNOVATION
VIA A. ALTOBIELLI 10
47900 RIMINI RN

DECLARAZIONE DI CONFORMITÀ ALLA DIRETTIVA REDDITA
Modello / Declaration of the manufacturer

Secondo la Norma / According to Standard
EN 12331 : 2003 + A2 : 2010 (UNI EN 12331 : 2010)

deiva
IMQ
S.p.A. - Milano

SPACCO

SPACCO

Il presente documento è valido solo se è accompagnato dal certificato di prova di prova
Il presente documento è valido solo se è accompagnato dal certificato di prova di prova



I MIGLIORI SCELGONO L'ECCELLENZA

TOP CHEFS GO FOR THE BEST!



Rolando Lolli

Chef "Select Hotels" - Cervia

Rolando Lolli



Mario Beccari

Chef "Select Hotels" - Cervia

Mario Beccari





Alcuni tra gli Chef stellati italiani hanno scelto FAMA INDUSTRIE per le loro cucine affidandosi alla vasta gamma di prodotti, tutti realizzati secondo gli stessi criteri di qualità e affidabilità, ma completamente versatili e adattabili a ogni situazione e ad ogni attività. Tecnologia e qualità al servizio delle migliori cucine.

Some of the Italian award-winning chefs have chosen FAMA equipment for their kitchens since FAMA INDUSTRIES offers a wide range of products. FAMA specialist equipment is manufactured to the highest standards for efficiency, durability and reliability. It provides state-of-the-art technology and quality answer to all the best kitchens preparation needs.



Roberto Scarpelli

Chef "Select Hotels" - Cervia



Enrico Lubrano

Chef "Ristorante Deserto" - Cervia



P.20

TI8 **TI12** **TI22** **TI32ECO**



P.24

TSK12 **TSK22** **TIK12** **TIK22**

P.28



TS12 ½ Unger Ghisa **TS22 ½** Unger Ghisa **TS22** Unger Totale Ghisa **TS12 ½** Unger Inox **TS22 ½** Unger Inox **TS22** Unger Totale Inox



P.32

TI12 R ½ Unger Inox **TI22 R ½** Unger Inox **TI22 R** Unger Totale Inox **TI32 RS** Unger Totale Inox **TI32 R** Unger Totale Inox



P.38

TGI8 **TGI12** **TGI22**



P.42

APPLICAZIONI



P.48

TS12 R **TG12 R** **GSR**



P.52

275GR **300GR** **330GR** **350GR**



P.16

TS8 **TS12** **TS22** **TS32**



P.22

TI12 R **TI22 R** **TI32 RS** **TI32 R** **TI12 R GHISA** **TI22 R GHISA**



P.26

TR22 **TR32**



P.30

TI12 ½ Unger Ghisa **TI22 ½** Unger Ghisa **TI22** Unger Totale Ghisa **TI12 ½** Unger Inox **TI22 ½** Unger Inox **TI22** Unger Totale Inox



P.36

TG8 **TG12** **TG22**



P.40

TGK12 **TGK22** **TGIK12** **TGIK22**



P.46

TS8 R **TG8 R** **GMR**



P.50

250R **300R** **220R** **250R**



P.58

GS **GSD** **GSM** **GD**



P. 64

350VF 450VF 650VF



P. 70/72

250VV 250VF



P. 78

220 250 220 ECO 250 ECO 275 ECO



P. 82

300 330 350 370



P. 88

PP5 Kg PP5 Kg PP10 Kg PP18 Kg



P. 94

TAGLIAVERDURE ÉLITE



P. 98

L9V L6V L4V



P. 102

TAGLIAMOZZARELLA



P. 59

GM GMR GMB GG HP2 GG HP4



P. 66

350VV 450VV 650VV



P. 74

300VV 400VV



P. 80

275 300 330 350



P. 84

300 350 370



P. 90

PC5 Kg PC5 Kg PC10 Kg PC18 Kg



P. 96

TAGLIAVERDURE



P. 100

L3 L5 L8



P. 104

IMPASTACARNE

**ISACCATRICI
inox**

P.108



FSV 32IT **FSV 35IT** **FSV 52IT** **FSV 32T** **FSV 32D** **FSV 32S**
FSV 45IT

P.110



FHA100 **FHA400** **FHA500**

P.116



PM7 **PK8** **PK10** **PK20**

P.122



7 Kg. **18 Kg.** **25 Kg.** **38 Kg.** **44 Kg.**

P.126



25 Kg. **35 Kg.**

P.128



MANUALE **ELETTRICA**

P.130



MF4D **MF4** **MSE** **MSP** **MSP2**

P.134



MG13 **MG20** **MG50**



P.106

SEGAOSSA 1550 A **SEGAOSSA 1830 A** **SEGAOSSA 1550 V** **SEGAOSSA 1830 V**



P.109

300 **350** **400**



P.114

BK10 **BK20** **BK30** **BK40**



P.118

PK4,5 **PK5** **PK7**



P.124

18 Kg. **25 Kg.** **38 Kg.** **44 Kg.**



P.127

L 30H **L 40H** **L 30I** **L 40P**
L 40I



P.129

320 **400** **500**



P.132

MT1 **MT1D** **MTQ** **MTFIVE** **MT1I** **MT1DI** **MT5**



P.135

MCF100 **MTG6** **MSG100**



P.136

FMC6 FMX CS CS DOPPIO GC GCP



P.139

MFR80R MFR280R MFR10R MFR210R



P.142

FPL 60/30 FPL 65/40 FPL 60/60 FPL 65/70



P.144

DECS11M FFM104PF FFM104C FFM103C FFM100S FFM101G FFM102U



P.148

FS40 FS70 FS60



P.150

MTP100 MTP101 MRT600 MRT700



P.154

UPM UPD PFIND30 PFIND35



P.156

FBR3600TN FBR2610TN FBR2600TN



P.158

FV12033 / FV15033 FFR650TN FFR1410TN FV18033 / FV20033 FFR650BT FFR1410BT



P.138

MFR40 MFR240 MFR80 MFR280



P.140

MFR12R MFR212R MFR12M MFR212M



P.143

FPL 60/30 B FPL 60/30 B2 BLOCCO COTTURA



P.146

B1 B1V B7 B8 B9 B1+1 B1+1V B7+7 B8+8 B9+9



P.149

Q4 Q6 Q12 Q18



P.152

PSINGS PCORTS PDR3000S PSING PCORT PDR3000



P.155

PFT3040V PFT3060V PFTM PFTD



P.157

FBR3100TN FBR2100TN





TRITACARNE / MEAT MINCERS

MEAT MINCERS



TRITACARNE GRATTUGIA / MEAT MINCER GRATERS
SERIE RETRÒ / RETRO MODELS

MEAT MINCER
GRATERS

MEAT MINCERS
UNITS

RETRÒ SLICING
MACHINES



GRATTUGIE / GRATERS

GRATERS



MIXER / MIXERS

MIXERS



AFFETTATRICI / SLICING MACHINES

SLICING
MACHINES



PREPARAZIONE DINAMICA / DYNAMIC PROCESSING

DYNAMIC
PROCESSING



LAVORAZIONE CARNE / MEAT PROCESSING

MEAT
PROCESSING



IMPASTATRICI / KNEADING MACHINES

KNEADING
MACHINES



SNACK BAR / SNACK BAR

SNACK BAR



COTTURA / COOKING EQUIPMENT

COOKING
EQUIPMENT



COTTURA / COOKING EQUIPMENT
REFRIGERATI / REFRIGERATED

REFRIGERATED



Ragù classico / *Classic ragù recipe*

Emilia Romagna



Preparazione / *Directions*

Preparare il battuto tritato per il soffritto classico: sedano, carote, cipolle, aglio e prezzemolo, riducete il tutto in un trito fine. Scaldare poco olio sul fondo di una casseruola in ghisa smaltata. Quando l'olio è ben caldo, deporre il soffritto nella casseruola. Far soffriggere le verdure tritate molto lentamente e a lungo. Quando la verdura è ben cotta e si è ridotta di volume, aggiungere la carne. Lasciare rosolare la carne per bene, cambiando completamente colore lasciatela diventare quasi marrone scuro. A questo punto sfumare con del vino rosso facendo evaporare l'alcol molto velocemente a fiamma vivace. Unire il concentrato di pomodoro e in seguito i pelati frullati. Salare adeguatamente e pepare a piacere. Lasciate cuocere a fuoco basso per 40 minuti.

Heat oil in a large heavy pot over medium-high heat. Add onions, celery, and carrots. Reduce heat to medium-low and sauté. When vegetables are softened, add beef. Stir until beef is well browned on all sides. Add red wine; boil 1 minute, stirring often and scraping up browned bits. Add tomato paste; stir to blend. Reduce heat to very low and gently simmer, stirring occasionally, until flavors meld, about 40 minutes. Season with salt and pepper.



INGREDIENTI / *INGREDIENTS*

4 carote
3 cipolle
4 coste di sedano
1 spicchio di aglio
1 ciuffo di prezzemolo
1,5 Kg carne macinata di manzo magro

Concentrato di pomodoro
800 g pomodoro pelato
500 ml di vino rosso
4 cucchiaini da tavola di olio extravergine d'oliva
Sale Q.b.
Pepe Nero Q.b.

*4 carrots
3 onions
4 celery
1 clove of garlic
1 parsley
1,5 Kg lean ground beef*

*Tomato concentrate
800 g peeled tomatoes
500 ml red wine
4 tablespoons of extra virgin olive oil
Salt to taste
Black pepper to taste*





TS12



GRUPPI DI MACINAZIONE / MINCING GROUPS

	Inox S/Steel	Alluminio Aluminium	Ghisa Cast Iron
TS8	●	●	
TS12	●	●	●
TS22	●	●	●
TS32	●		●



TS8



TS12



TS22

- Apparecchi per uso professionale
- Indispensabili per macellerie, ristoranti, alberghi, mense
- Costruiti in lega di alluminio pressofuso e lucidato
- Elegante fascia in acciaio inossidabile sulla carcassa motore
- Ingranaggi elicoidali in acciaio temperato a bagno d'olio
- Motore asincrono ventilato con termica di protezione
- Gruppo macinazione carne asportabile disponibile in:
 - a) Ghisa alimentare con trattamento electroless nickel plating (12-22-32)
 - b) Alluminio anodizzato (12-22)
 - c) Acciaio inossidabile AISI 304 (8-12-22-32)
- Trafile auto affilanti in acciaio inox di serie
- Set per insaccare (a richiesta)
- Inversione di marcia (a richiesta)
- Dimensioni alimentazione 120 x 52 mm
- Dimensioni scarico 8/60 mm 12/70 mm 22/82 mm 32/ 98 mm
- Tramoggia e piatto raccolta in acciaio inox
- Pestello in ABS
- Comandi a 24 volt
- Versione TS 8 consigliato per uso domestico e piccole attività
- Versione TS 8 non disponibile con l'inversione di marcia
- Fabbricato in Italia

- Professional equipment
- Ideally suited for hotels, restaurants, tables, butcheries, etc
- Structured in polished pressure die cast aluminium alloy
- Elegant stainless steel motor cover band
- Oil immersed gears made from hardened steel
- Ventilated asynchronous motor with thermal protection included
- Easy-removable mincing unit available in:
 - a) ELECTROLESS NIKEL PLATED CAST IRON (MOD.12-22-32)
 - b) ANODIZED ALUMINIUM (MOD.12-22)
 - c) AISI 304 STAINLESS STEEL (MOD.8-12-22-32)
- Stainless steel self-sharpening draw-plates included
- Sausage filling kit available on demand
- Gear inversion option available on demand
- Loading meat inlet dimensions: 120x52 mm
- Output mouth dimensions: mod.8/Ø 60 mm. - mod.12/Ø 70 mm. - mod.22/Ø 82 mm. - mod.32/Ø 98 mm.
- Stainless steel tray and hopper
- ABS pestle
- 24 volt controls
- Model TS 8 is recommended for home use and small business use
- Model TS 8 is not available with gear inversion
- Proudly Made in Italy



gruppo di macinazione modello ENTERPRISE 12,
altri gruppi di macinazione disponibili a pag. 054
mincing groups ENTERPRISE 12 model,
other mincing groups available at page 054

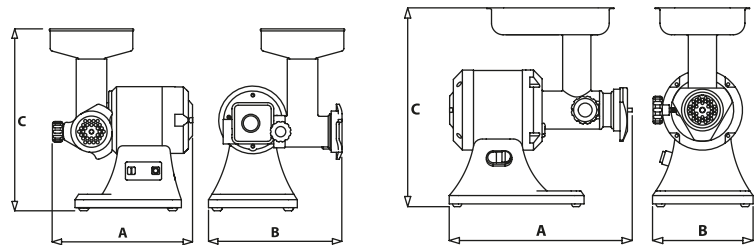

	A	B	C	Alimentazione Power supply	Potenza Motor power	Giri/min coclea Screw revolution (RPM)	Produzione oraria Production per hour	Bocca Mouth	Piastra in dotazione Standard plate	Peso netto mono/tri fase Net weight single/three phase	Dimensioni imballo Packing dimensions	Peso lordo mono/tri fase Gross weight single/three phase
	mm	mm	mm	Volt/Hz	Kwatt/Hp		kg	mm	mm	kg	mm	kg
TS8	270	260	360	230/50	0,38 (0,50)	80	20	Ø60	Ø 6	9,0	310x260x370	10,0
TS12	370	220	440	230/50 - 230-400/50	0,75 (1,00)	200	200	Ø70	Ø 6	19,0/16,0	440x250x440	21,0/18,0
TS22	440	240	510	230/50 - 230-400/50	1,10 (1,50)	140	300	Ø82	Ø 6	24,0/22,0	480x300x510	26,5/24,5
TS32	500	240	510	230/50 - 230-400/50	1,50 (2,00)	140	400	Ø98	Ø 6	33,0/32,0	590x370x520	36,0/35,0



TS32





Zucchine tonde ripiene / Stuffed courgettes

Toscana



Preparazione / Directions

Preparare il brodo vegetale. Lavare le zucchine sotto l'acqua, asciugarle e tagliare la calotta per formare un cappello. Tagliare il perimetro interno con un coltello, incidere una croce nella polpa per estrarla un po' alla volta e scavarne l'interno con un cucchiaino e lasciare 1 cm di spessore. Salare l'interno delle zucchine e capovolgerle su un vassoio per drenarle dal liquido di vegetazione.

Ripieno: versare in una ciotola la carne tritata e aggiungete la salsiccia tritata. Unire anche la polpa delle zucchine tritate, il Parmigiano grattugiato, le uova e la mollica di pane, il prezzemolo tritato, l'aglio schiacciato; mescolare il tutto fino ad ottenere un composto omogeneo. Riempire le zucchine fino all'orlo con il ripieno di carne. Ungere una teglia con un filo d'olio e riporre le zucchine ripiene all'interno; aggiungere nella teglia un mestolo di brodo vegetale. In una teglia a parte appoggiare un foglio di carta da forno e disporre le calotte; cuocere in forno preriscaldato a 180° per 45 minuti; potete togliere uno' prima le calotte. Sfnare e servire.

Cut each courgette in half crosswise. Using a melon baller, carefully scoop out courgette's flesh, leaving about 1 cm flesh intact on all sides and leaving courgettes closed at the bottom of each half. For the stuffing, mix the beef and sausage meat with the other ingredients (eggs, internal soft part of bread, garlic, parsley, Parmigiano cheese and the courgette's flesh) until flavors meld. Sprinkle the stuffing on top of the courgettes and drizzle with oil and broth. Heat oven to 180 C° and bake for 45 mins or until the courgettes are softened. Wait till the topping is golden and crisp and serve.



INGREDIENTI / INGREDIENTS

8 zucchine tonde (circa 250 g l'una)
250 g carne di suino trita
200 g di salsiccia
2 uova medie
70 g di parmigiano reggiano grattugiato
2 cucchiaini di prezzemolo tritato

1 spicchio d'aglio
Pepe nero q.b.
50 g di mollica di pane
Sale q.b.
2 cucchiaini di olio di oliva extravergine
1 mestolo di brodo vegetale

*8 round courgettes (8 x 250 g)
250 g ground pig meat
200 g di sausage
2 eggs
70 g grated parmesan
2 spoons of grated parsley*

*1 clove of garlic
black pepper to taste
50 g breadcrumbs
salt to taste
2 spoon of extra virgin olive oil
1 ladle of vegetable broth*

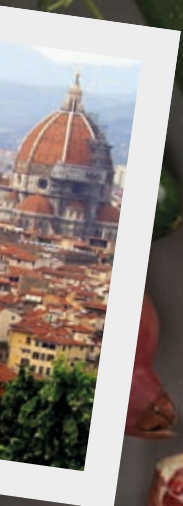



TI22

GRUPPI DI MACINAZIONE / MINCING GROUPS

	Inox S/Steel	Alluminio Aluminium	Ghisa Cast Iron
TI8	●	●	
TI12	●	●	●
TI22	●	●	●
TI32 ECO	●		●



TI8



TI12



TI22

- Apparecchi per uso professionale
 - Ideali per macellerie, ristoranti, alberghi, mense
 - Struttura in acciaio inossidabile lucidato
 - Ingranaggi elicoidali in acciaio temperato a bagno d'olio
 - Motore asincrono ventilato con termica di protezione
 - Gruppo macinazione carne asportabile disponibile in:
 - a) Ghisa alimentare con trattamento electroless nickel plating (12-22-32)
 - b) Alluminio anodizzato (8-12)
 - c) Acciaio inossidabile AISI 304 (8-12-22-32)
 - Truffle auto affilanti in acciaio inox di serie
 - Set per insaccare (a richiesta)
 - Inversione di marcia (a richiesta)
 - Dimensioni alimentazione 120 x 52 mm
 - Dimensioni scarico 8/60 mm 12/70 mm 22/82 mm 32/98 mm
 - Tramoggia e piatto raccolta in acciaio inox
 - Pestello in ABS
 - Comandi a 24 volt
 - Versione T18 consigliato per uso domestico e piccole attività
 - Versione T18 non disponibile con l'inversione di marcia
 - Fabbricato in Italia
- Professional equipment
 - Ideally suited for hotels, restaurants, tables, butcheries, etc
 - Structured in polished stainless steel
 - Oil immersed steel gears
 - Ventilated asynchronous motor with thermal protection included
 - Easy-removable mincing unit available in:
 - a) electroless nickel plated cast iron (mod.12-22-32)
 - b) anodized aluminium (mod. 8/12)
 - c) AISI 304 stainless steel (mod. 8-12-22-32)
 - Stainless steel self-sharpening draw-plates included
 - Sausage filling kit available on demand
 - Gear inversion option available on demand
 - Loading meat inlet dimensions: 120x52 mm
 - Output mouth dimensions: mod.8/Ø 60 mm. - mod.12/Ø 70 mm. - mod.22/Ø 82 mm. - mod.32/Ø 98 mm.
 - Stainless steel tray and hopper
 - ABS pestle
 - 24 volt controls
 - Model T18 is recommended for home use and small business use
 - Model T18 is not available with gear inversion
 - Proudly Made in Italy



gruppo di macinazione modello ENTERPRISE INOX, altri gruppi di macinazione disponibili a pag. 054
 mincing groups ENTERPRISE INOX model, other mincing groups available at page 054

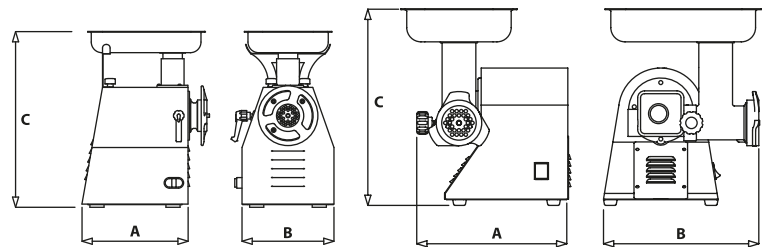

	A	B	C	Alimentazione Power supply	Potenza Motor power	Giri/m RPM	Produzione oraria Production per hour	Bocca Mouth	Piastra in dotazione Standard plate	Peso netto mono/tri fase Net weight single/three phase	Dimensioni imballo Packing dimensions	Peso lordo mono/tri fase Gross weight single/three phase
	mm	mm	mm	Volt/Hz	Kwatt/Hp		kg	mm	mm	kg	mm	kg
T18	270	280	350	230/50	0,38 (0,50)	80	20	Ø60	Ø 6	10	310x260x370	11,0
T112	430	215	440	230/50 - 230-400/50	0,75 (1,00)	200	200	Ø70	Ø 6	22,0/20,0	480x300x510	24,0/22,0
T122	440	215	440	230/50 - 230-400/50	1,10 (1,50)	140	300	Ø82	Ø 6	25,0/23,0	480x300x510	27,5/25,5
T132 ECO	500	225	510	230/50 - 230-400/50	1,50 (2,00)	140	400	Ø98	Ø 6	36,0/35,0	590x370x520	39,0/38,0



T132 ECO





TI12 R



gruppo di macinazione modello ENTERPRISE INOX,
altri gruppi di macinazione disponibili a pag. 054
*mincing groups ENTERPRISE INOX model,
other mincing groups available at page 054*

GRUPPI DI MACINAZIONE / MINCING GROUPS

	Inox S/Steel	Alluminio Aluminium	Ghisa Cast Iron
TI12 R	●	●	●
TI22 R	●	●	●
TI32 RS	●		
TI32 R	●		



TI12 R



TI22 R



TI32 RS

- Apparecchio per uso professionale molto potente
- Macellerie, supermarket, grandi comunità
- Struttura in robusta lamiera di acciaio inox AISI 304
- Riduttore ermetico a bagno d'olio
- Motore asincrono ventilato
- Termica di protezione
- Ventola di raffreddamento supplementare nel modello 32
- Bocca carne "enterprise" asportabile disponibile in:
 - a) Ghisa alimentare (12-22) (electroless nickel plating)
 - b) Alluminio anodizzato (12-22)
 - c) Acciaio inossidabile AISI 304 (12-22-32)
- Trafile auto affilanti in acciaio inox di serie
- Disponibile set per insaccare
- nversione di marcia
- Tubo carico carne 52mm per 120 mm
- Dimensioni scarico 12/70 mm 22/82 mm 32/98 mm
- Tramoggia e piatto raccolta prodotto in acciaio inox
- Pestello in ABS
- Centralina elettronica a 24 volt
- Pulsante avviamento termoplastico protetto da membrana in lattice di gomma
- Produzione italiana

- *Heavy duty Professional equipment*
- *Ideally suited for butcheries, supermarkets, etc*
- *Structured in AISI 304 stainless steel*
- *Hermetic steel Oil immersed reducer*
- *Ventilated asynchronous motor thermal protection included*
- *Optional cooling fan available for mod. 32*
- *Easy-removable enterprise mouth unit available in:*
 - a) *electroless nickel plated cast iron (mod.12-22)*
 - b) *anodized aluminium (mod.12/22)*
 - c) *AISI 304 stainless steel (mod.12-22-32)*
- *Stainless steel self-sharpening draw-plates included*
- *Sausage filling kit available on demand*
- *Gear inversion option available*
- *Loading meat inlet dimensions: 120x52 mm*
- *Output mouth dimensions: mod.12/Ø 70 mm. - mod.22/Ø 82 mm. - mod.32/Ø 98 mm.*
- *Stainless steel tray and hopper*
- *ABS pestle*
- *Central control system requires 24 volt low tension*
- *On/off switch protection with waterproof rubber cover*
- *Proudly Made in Italy*

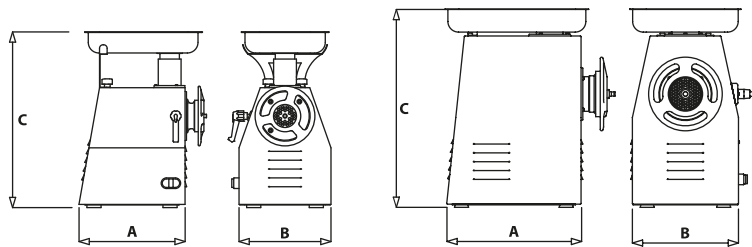

	A	B	C	Alimentazione Power supply	Potenza Motor power	Gir/m RPM	Produzione oraria Production per hour	Bocca Mouth	Piastra in dotazione Standard plate	Peso netto mono/tri fase Net weight single/three phase	Dimensioni imballo Packing dimensions	Peso lordo mono/tri fase Gross weight single/three phase
	mm	mm	mm	Volt/Hz	Kwatt/Hp		kg	mm	mm	kg	mm	kg
TI12 R	400	260	490	230/50 - 230-400/50	1,10 (1,50)	140	250	Ø70	Ø 6	26,0/26,0	480x300x510	28,0/28,0
TI22 R	450	260	530	230/50 - 230-400/50	1,50 (2,00)	140	400	Ø82	Ø 6	32,0/32,0	590x370x520	34,5/34,5
TI32 RS	510	260	525	230/50 - 230-400/50	1,60 (2,20)	140	500	Ø98	Ø 6	40,0/40,0	590x370x520	43,0/43,0
TI32 R	475	300	560	230/50 - 230-400/50	2,20 (3,00)	140	600	Ø98	Ø 6	52,0/46,0	620x430x650	55,0/49,0

TI32 R

TI12 R GHISA

TI22 R GHISA



TSK12

GRUPPI DI MACINAZIONE / MINCING GROUPS

	Inox S/Steel	Alluminio Aluminium	Ghisa Cast Iron
TSK12	●		
TSK22	●		
TIK12	●		
TIK22	●		



TSK12



TSK22



TIK12

- Apparecchi per uso professionale
- Ideali per ristoranti, alberghi, mense
- Corpo in lega di alluminio pressofuso (TSK)
- Struttura in acciaio inox AISI 304 (TIK)
- Sistema di riduzione ad ingranaggi elicoidali a bagno d'olio
- Robusto motore asincrono di produzione nazionale
- Termica di protezione
- Gruppo macinazione carne "enterprise" asportabile in acciaio inox AISI 304
- Trafile auto affilanti in acciaio inox di serie
- Disponibile set per insaccare (optional)
- Disponibile con inversione di marcia
- Dimensioni alimentazione 120x52 mm
- Dimensione scarico 12/70 mm 22/82 mm
- Tramoggia e piatto raccolta prodotto in acciaio inox
- Pestello in ABS
- Comandi a 24 volt
- Produzione italiana



- Professional equipment
- Ideally suited for hotels, restaurants, tables, etc
- Pressure die cast aluminium alloy cover casing (TSK)
- Structured in AISI 304 stainless steel (TIK)
- Speed reducer with oil immersed gears
- Heavy duty Italian make asynchronous motor
- Thermal protection
- AISI 304 stainless steel easy-removable "ENTERPRISE" mincing unit
- Stainless steel self-sharpening draw-plates included
- Sausage filling kit available on demand
- Gear inversion option available
- Loading meat inlet dimensions: 120x52 mm
- Output mouth dimensions: mod.12/Ø 70 mm. - mod.22/Ø 82 mm
- Stainless steel tray and hopper
- ABS pestle
- 24 volt controls
- Proudly Made in Italy

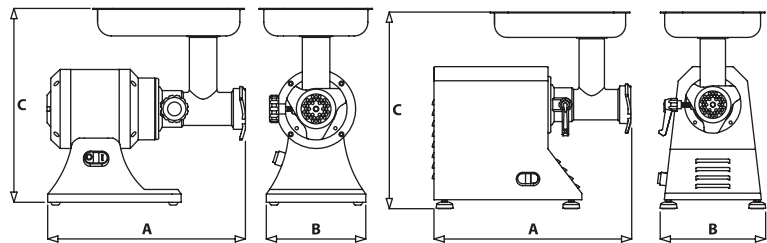

	A	B	C	Alimentazione Power supply	Potenza Motor power	Giri/m RPM	Produzione oraria Production per hour	Bocca Mouth	Plastra in dotazione Standard plate	Peso netto mono/tri fase Net weight single/three phase	Dimensioni imballo Packing dimensions	Peso lordo mono/tri fase Gross weight single/three phase
	mm	mm	mm	Volt/Hz	Kwatt/Hp		kg	mm	mm	kg	mm	kg
TSK12	440	220	440	230/50 - 230-400/50	0,75 (1,00)	200	200	Ø70	Ø 6	21,0/18,0	480x300x510	23,5/20,5
TSK22	490	240	500	230/50 - 230-400/50	1,10 (1,50)	140	300	Ø82	Ø 6	25,0/23,0	480x300x510	27,5/25,5
TIK12	480	215	430	230/50 - 230-400/50	0,75 (1,00)	200	200	Ø70	Ø 6	24,0/23,0	480x300x510	26,5/25,5
TIK22	500	225	510	230/50 - 230-400/50	1,10 (1,50)	140	300	Ø82	Ø 6	27,0/25,0	480x300x510	29,5/27,5

TIK22

gruppo di macinazione 12/22 UNIKO ENTERPRISE, altri gruppi di macinazione disponibili a pag. 054
mincing groups 12/22 UNIKO ENTERPRISE model, other mincing groups available at page 054



TRITACARNE REFRIGERATO

REFRIGERATED MEAT MINCER



TR22



GRUPPI DI MACINAZIONE / MINCING GROUPS

	Inox S/Steel	Alluminio Aluminium	Ghisa Cast Iron
TR22	●	●	●
TR32	●		



TR22



TR32



- Apparecchi per uso professionale
- Indicati per macellerie e supermarket
- Monoblocco in acciaio inossidabile
- Motore asincrono ventilato e Motoriduttore a bagno d'olio
- Gruppo macinazione in acciaio inox
- Tramoggia refrigerata
- Coperchio in plexiglass trasparente
- Gas 138
- Temperatura -2 +4
- Trasmissione a ingranaggi
- Termica di protezione
- Facile da pulire
- Norme CE
- Fabbricato in Italia

- Professional equipment
- Ideally suited for butcheries, supermarkets, etc
- Stainless steel cover casing
- Ventilated and permanently lubricated geared electrical motor
- Cutting unit and knob completely in stainless steel
- Refrigerated hopper
- Plexyglass transparent lid
- Constant cooling by hermetic compressor with 138 Gas
- Homogeneous temperature during all cutting process, adjustable from -2° to +4°C
- Stainless steel drive gears
- Thermal overload protection included
- Entirely detachable for easy cleaning
- CE approved
- Proudly Made in Italy



gruppo di macinazione 32 ENTERPRISE, altri gruppi di macinazione disponibili a pag. 054
 mincing groups 32 ENTERPRISE model, other mincing groups available at page 054

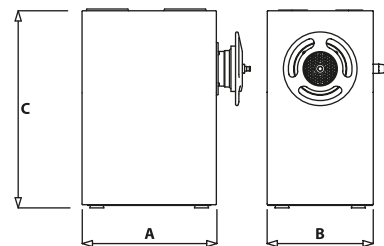

	A	B	C	Alimentazione Power supply	Potenza Motor power	Gir./m RPM	Produzione oraria Production per hour	Bocca Mouth	Piastra in dotazione Standard plate	Peso netto tri fase Net weight three phase	Dimensioni imballo Packing dimensions	Peso lordo tri fase Gross weight three phase	Gas
	mm	mm	mm	Volt/Hz	Kwatt/Hp		kg	mm	mm	kg	mm	kg	Gas
TR22	430	260	530	230-400/50	0,90 (1,20)	120	280	ø82	ø 6	43,0	360x600x600	46,0	R134°
TR32	520	320	550	230-400/50	1,85 (2,50)	120	450	ø98	ø 6	56,0	420x700x655	59,0	R134°



TRITACARNE SERIE TS UNGER

UNGER MEAT MINCERS TS MODELS

- Apparecchi per uso professionale
- Ideali per ristoranti, alberghi, mense
- Corpo in lega di alluminio pressofuso (TS)
- Gruppo macinazione asportabile in ghisa alimentare o acciaio inossidabile
- TS 12 mezzo unger (2 piastre e 1 coltello)
- TS 22 mezzo unger e totale (2 coltelli e 3 piastre)
- Dimensioni alimentazione 52 mm per 120 mm
- Dimensioni scarico 12/70 mm 22/82 mm 32/98 mm

- Professional equipment
- Ideally suited for restaurants, hotels, tables, etc
- Pressure die cast aluminium alloy cover casing (TS)
- Easy-removable enterprise mincing unit available in cast iron or stainless steel:
- HALF UNGER TS 12 come with 2 plates (0 mm.+4.5mm.) and 1 knife
- HALF UNGER TS 22 come with 2 plates (0 mm.+4.5mm.) and 1 knife
- TOTAL UNGER TS 22 come with 3 plates (0 mm.+4.5mm.+ 10 mm.) and 2 knives
- Loading meat inlet dimensions: 120x52 mm
- Output mouth dimensions: mod.12/Ø 70 mm. - mod.22/Ø 82 mm. - mod.32/Ø 98 mm.

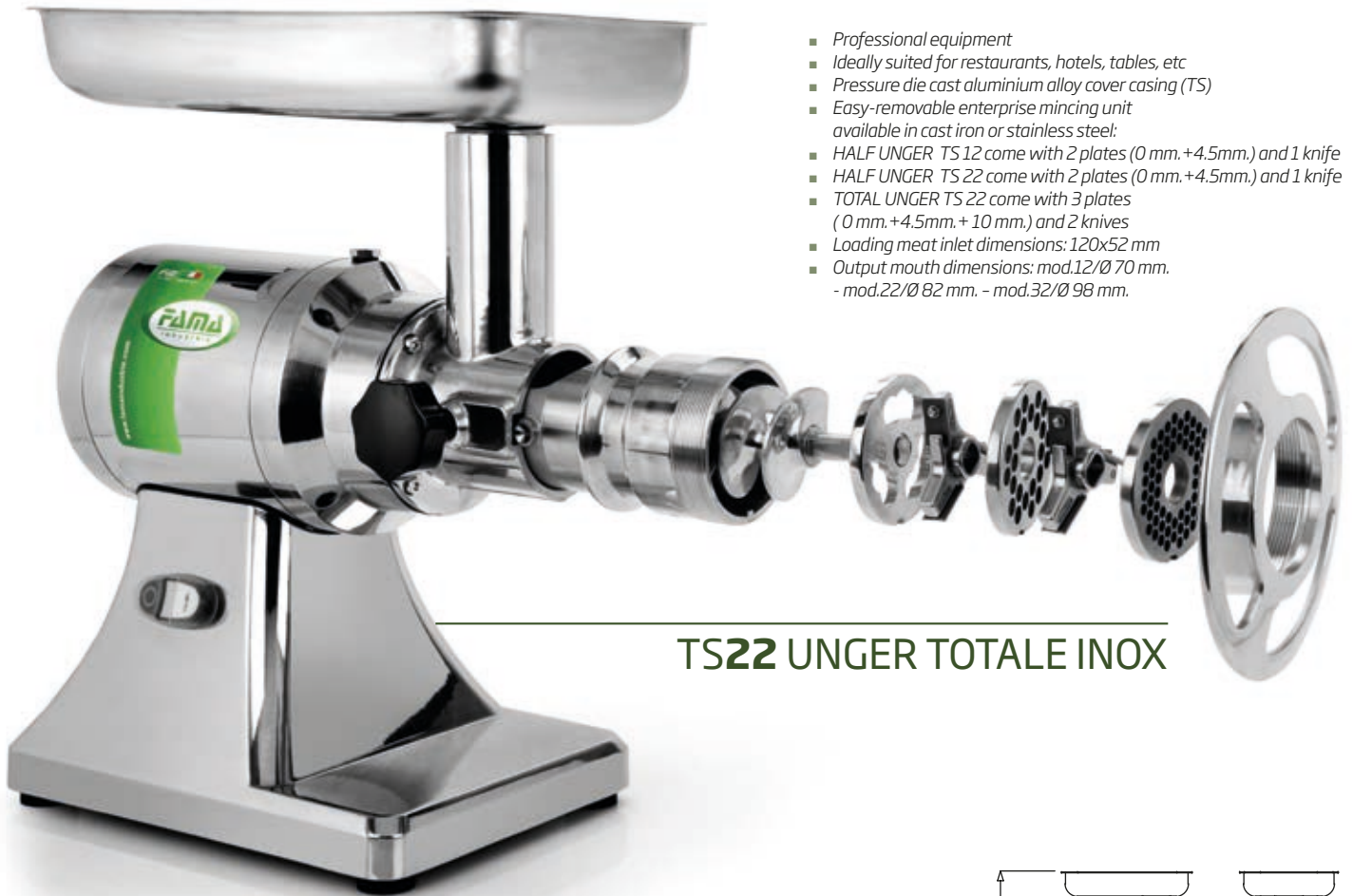

TS22 UNGER TOTALE INOX

GRUPPI DI MACINAZIONE / MINCING GROUPS

	Inox S/Steel	Alluminio Aluminium	Ghisa Cast Iron
TS12 UNGER	●		●
TS22 UNGER	●		●

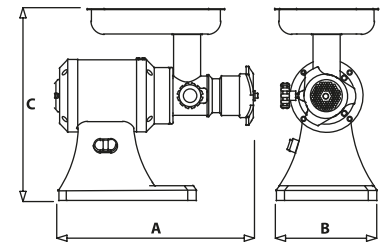

TS12 ½ UNGER GHISA



TS22 ½ UNGER GHISA



TS22 UNGER TOTALE GHISA



½ UNGER INOX
½ UNGER S/STEEL

gruppo di macinazione modello 12/22 1/2 UNGER INOX, altri gruppi di macinazione disponibili a pag. 054
mincing groups 12/22 1/2 UNGER model, other mincing groups available at page 054



UNGER GHISA TOTALE
TOTAL UNGER CAST IRON

gruppo di macinazione modello UNGER TOTALE 22 GHISA, altri gruppi di macinazione disponibili a pag. 054
mincing groups TOTAL UNGER 22 CAST IRON model, other mincing groups available at page 054

	A mm	B mm	C mm	Alimentazione Power supply Volt/Hz	Potenza Motor power Kwatt/Hp	Giri/m RPM	Produzione oraria Production per hour kg	Bocca Mouth mm	Piastra in dotazione Standard plate mm	Peso netto mono/tri fase Net weight single/three phase kg	Dimensioni imballo Packing dimensions mm	Peso lordo mono/tri fase Gross weight single/three phase kg
TS12 UNGER	460	240	510	230/50 - 230-400/50	1,10 (1,50)	140	200	ø70	ø6	23,0/21,0	480x300x510	25,5/23,5
TS22 UNGER	470	240	510	230/50 - 230-400/50	1,10 (1,50)	140	300	ø82	ø6	25,0/23,0	480x300x510	27,5/25,5



TS12 ½ UNGER INOX



TS22 ½ UNGER INOX



TS22 UNGER TOTALE INOX



- Gruppo macinazione asportabile in ghisa alimentare o acciaio inossidabile
- T112 solo mezzo unger
- T122 sia mezzo unger che unger totale
- T132 solo unger totale
- Dimensioni alimentazione 52 mm per 120 mm
- Dimensioni scarico 12/70 mm 22/82 mm 32/98 mm
- Pulsante avviamento termoplastico

- *Easy-removable mincing unit available in cast iron or stainless steel*
- *T112 MODEL is available only in HALF UNGER version*
- *T122 MODEL is available both in HALF and TOTAL UNGER versions*
- *T132 MODEL is available only in TOTAL UNGER version*
- *Loading meat inlet dimensions: 120x52 mm*
- *Output mouth dimensions:
mod.12/Ø 70 mm. - mod.22/Ø 82 mm. - mod.32/Ø 98 mm.*
- *On/off switch protection with waterproof rubber cover*



TI22 UNGER TOTALE INOX

GRUPPI DI MACINAZIONE / MINCING GROUPS

	Inox S/Steel	Alluminio Aluminium	Ghisa Cast Iron
TI12 UNGER	●		●
TI22 UNGER	●		●



TI12 ½ UNGER GHISA



TI22 ½ UNGER GHISA



TI22 UNGER TOTALE GHISA



gruppo di macinazione modello 12/22 1/2 UNGER INOX
mincing groups 12/22 1/2 UNGER model

gruppo di macinazione modello UNGER TOTALE 22 GHISA
mincing groups TOTAL UNGER 22 CAST IRON model

gruppo di macinazione modello UNGER TOTALE 32 INOX
mincing groups TOTAL UNGER 32 S/STEEL model

altri gruppi
di macinazione
disponibili a pag. 054
other mincing groups
available at page 054

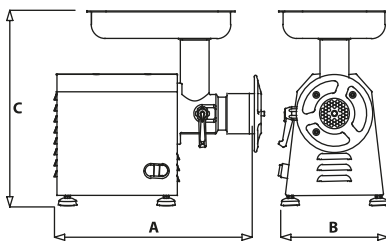

	A	B	C	Alimentazione Power supply	Potenza Motor power	Giri/m RPM	Produzione oraria Production per hour	Bocca Mouth	Piastra in dotazione Standard plate	Peso netto mono/tri fase Net weight single/three phase	Dimensioni imballo Packing dimensions	Peso lordo mono/tri fase Gross weight single/three phase
	mm	mm	mm	Volt/Hz	Kwatt/Hp		kg	mm	mm	kg	mm	kg
TI12 UNGER	450	220	440	230/50 - 230-400/50	1,10 (1,50)	140	200	ø70	ø 6	24,0/22,0	590x300x430	26,5/24,5
TI22 UNGER	470	220	440	230/50 - 230-400/50	1,10 (1,50)	140	300	ø82	ø 6	26,0/24,0	590x300x430	28,5/26,5



TI12 1/2 UNGER INOX



TI22 1/2 UNGER INOX



TI22 UNGER TOTALE INOX



TRITACARNE SERIE TI R UNGER

UNGER MEAT MINCERS TI R MODELS

- Gruppo macinazione asportabile in ghisa alimentare o acciaio inossidabile
- Dimensioni alimentazione 52 mm per 120 mm
- Dimensioni scarico 12/70 mm 22/82 mm 32/98 mm
- Pulsante avviamento termoplastico

- Easy-removable mincing unit available in cast iron or stainless steel
- Loading meat inlet dimensions: 120x52 mm
- Output mouth dimensions:
mod.12/Ø 70 mm. - mod.22/Ø 82 mm. - mod.32/Ø 98 mm.
- On/off switch protection with waterproof rubber cover



TI22R UNGER TOTALE INOX



GRUPPI DI MACINAZIONE / MINCING GROUPS

	Inox S/Steel	Alluminio Aluminium	Ghisa Cast Iron
TI12R UNGER	●		●
TI22R UNGER	●		●
TI32RS UNGER	●		
TI32R UNGER	●		



TI12R 1/2 UNGER INOX



TI22R 1/2 UNGER INOX



TI22R UNGER TOTALE INOX



gruppo di macinazione modello 12/22 1/2 UNGER INOX
mincing groups 12/22 1/2 UNGER model

gruppo di macinazione modello UNGER TOTALE 22
GHISAmincing groups TOTAL UNGER 22 CAST IRON model

gruppo di macinazione modello UNGER TOTALE 32
INOXmincing groups TOTAL UNGER 32 S/STEEL model

altri gruppi
di macinazione
disponibili a pag. 054
other mincing groups
available at page 054

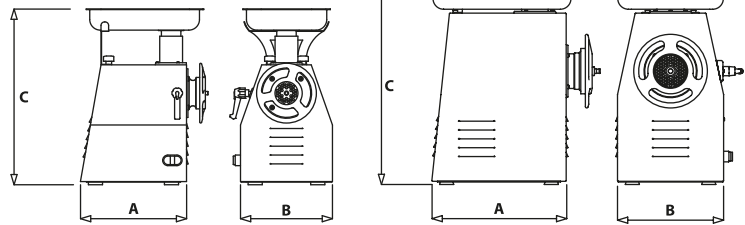

TI12/22RS UNGER GHISA

	A mm	B mm	C mm	Alimentazione Power supply Volt/Hz	Potenza Motor power Kwatt/Hp	Giri/m RPM	Produzione oraria Production per hour kg	Bocca Mouth mm	Pastra in dotazione Standard plate mm	Peso netto mono/tri fase Net weight single/three phase kg	Dimensioni imballo Packing dimensions mm	Peso lordo mono/tri fase Gross weight single/three phase kg
TI12R UNGER	420	260	490	230/50 - 230-400/50	1,10 (1,50)	140	250	ø70	ø 6	27,0/27,0	480x300x510	29,5/29,5
TI22R UNGER	480	260	530	230/50 - 230-400/50	1,50 (2,00)	140	400	ø82	ø 6	33,0/33,0	590x370x520	35,5/35,5
TI32RS UNGER	510	260	525	230/50 - 230-400/50	1,60 (2,20)	140	500	ø98	ø 6	40,0/40,0	590x370x520	43,0/43,0
TI32R UNGER	510	300	560	230/50 - 230-400/50	2,20 (3,00)	140	600	ø98	ø 6	54,0/48,0	620x430x650	57,0/51,0



TI32RS UNGER TOTALE INOX



TI32R UNGER TOTALE INOX



Supplì di carne alla romana *Meat Supplì fried rice balls stuffed with meat*

Lazio



Preparazione / Directions

Preparare il ripieno di carne tritata facendo soffriggere un cucchiaio di cipolla, uno di carota e uno di sedano, unire la carne e soffriggere mescolando di tanto in tanto, versare la passata di pomodoro e poco zucchero, salare, pepare e cuocere facendo restringere la salsa. Scaldare l'acqua per il riso mantenendola calda. In un altro tegame, far soffriggere la cipolla tritata, e stufarla aggiungendo un po' di vino. Quando il vino si è ridotto, unire il riso e farlo tostare bene, aggiungere due mestoli di acqua calda, mescolare e unire la salsa di carne calda. Portare il riso a cottura, aggiungendo di tanto in tanto un po' acqua. Infine mantecare con una noce di burro e il parmigiano grattugiato. Versare il riso in una teglia lasciandolo raffreddare completamente coperto con uno strofinaccio in frigo. Formare poi delle palline, fare un buco al centro dove si posizionerà un cubetto di mozzarella, richiudere il buco e rotolare la pallina di riso fra i palmi delle mani. Formare tutti i supplì, passarli tutti prima nella farina, poi nelle uova sbattute in una ciotola usando due forchette quindi rotolarli nel pangrattato e friggerli bene nell'olio bollente. Quando raggiungeranno un bel colore dorato scolarli e porli su un vassoio con della carta paglia, per togliere l'eccesso di olio, servirli caldi.

Heat the olive oil in a large saucepan over medium heat. Crumble in the meat and add the onion. Cook, stirring often, until the water given off by the meat is evaporated and the meat and onion begin to brown, about 10 minutes. Season the beef and onion lightly with salt. Stir in the carrots and celery and continue cooking until the vegetables are tender, about 10 minutes. Stir in the tomatoes, paste and salt to taste. Adjust the heat to simmering and continue cooking, stirring occasionally, until the sauce is thickened, about 30 minutes. The finished ragù should be dense and reduced. In a medium saucepan, bring the broth to a simmer over high heat. Reduce the heat to low and keep the broth hot. In a large, heavy saucepan, melt 2 tablespoons of the butter over medium heat. Add the onion and cook, stirring frequently until tender, about 3 minutes. Add the rice and stir to coat with the butter. Add the wine and simmer until most of the liquid has evaporated, about 1 minute. Add 1/2 cup hot broth and stir until almost completely absorbed, about 2 minutes. Continue cooking the rice, adding the broth, 1/2 cup at a time, stirring constantly and allowing each addition of broth to absorb before adding the next. Cook the rice until tender but still firm to the bite and the mixture is creamy, about 20 minutes. Remove the pan from the heat and stir in the remaining butter, Parmesan cheese, salt, and pepper. Cover and chill it in the fridge. With damp hands, using about 2 tablespoons of the risotto mixture, form the mixture into balls. Make a hole in the center of each ball and insert a cube of mozzarella cheese. Using both hands, gently work the rice so that it completely encloses the meat sauce and cheese, slowly closing your hands over the rice ball to make it perfectly round. Continue forming rice balls with the remaining rice and ragù. Dredge one rice ball in flour to coat all sides. Tap off excess flour. Roll the rice ball in the beaten egg to coat, allowing any excess egg to drip back into the bowl. Finally, roll the rice ball in the bread crumbs, pressing lightly to coat evenly with the crumbs. Pour olive oil in a deep and large pot. When the oil comes to temperature, carefully slip 4 or 5 rice balls into the oil. Fry, turning as necessary with tongs or a slotted spoon, until golden brown and crisp on all sides. Place them on the paper towel-lined baking sheet, and serve warm.



INGREDIENTI / INGREDIENTS

Ingredienti per il ripieno di carne

1,2 l di passata di pomodoro
750 g di carne tritata
2 cucchiaini di zucchero
Cipolla, sedano e carota tritati q.b.
Burro e olio q.b.
Sale e pepe q.b.

Ingredienti per il risotto

900 gr. di riso
1 cipolla piccola
Burro q.b.
½ bicchiere di vino bianco
1,8 l di acqua calda per cuocere il riso
300 gr. di parmigiano grattugiato
400 gr. di mozzarella a cubetti
Farina q.b.
4 uova intere
Pane grattugiato q.b.
Olio di semi per friggere q.b.

Ingredients for stuffing of meat

1,2 l tomato puree
750 g minced meat
2 spoon of sugar
Onion, celery and minced carrots
Butter and oil to taste
Salt and pepper to taste

Ingredients for risotto

900 g rice
1 onion
Butter to taste
½ Glass of white wine
1,8 l hot water
300 g grated parmesan
400 g Cubes mozzarella
Flour to taste
4 eggs
Breadcrumbs to taste
Seed oil for frying





TRITACARNE E GRATTUGIA SERIE TG

MEAT MINCER AND GRATER TG MODELS



TG12

GRUPPI DI MACINAZIONE / MINCING GROUPS

	Inox S/Steel	Alluminio Aluminium	Ghisa Cast Iron
TG8	•	•	
TG12	•	•	•
TG22	•	•	•



TG8



TG12



TG22

- Apparecchio per uso professionale
- Ideale per ristoranti, alberghi, mense
- Costruiti in lega di alluminio pressofuso
- Lamiera in acciaio inox AISI 304 sul corpo motore
- Sistema di riduzione ad ingranaggi elicoidali a bagno d'olio
- Motore asincrono produzione nazionale - Termica di protezione
- Gruppo macinazione carne asportabile disponibile in:
 - a) Ghisa alimentare (12-22) trattamento electroless nikel plating
 - b) Alluminio anodizzato (8-12-22)
 - c) Acciaio inossidabile AISI 304 (8-12-22)
- Trafilte auto affilanti in acciaio inox di serie
- Disponibile con inversione di marcia
- Dimensione alimentazione 120 x 52 mm
- Dimensione scarico 8/60 mm 12/70 mm 22/82 mm
- Tramoggia e piatto raccolta prodotto in acciaio inox
- Rullo in acciaio con trattamento electroless nikel plating
- Disponibile rullo in acciaio inox AISI 304
- Scodella formaggio in acciaio inox
- Grata di protezione allo scarico bocca grattugia inox
- Micro di protezione alla grattugia
- Pestello in ABS - Comandi a 24 volt (solo versione CE)
- Versione TG18 consigliato per uso domestico e piccole attività
- Produzione italiana

- Professional equipment
- Ideally suited for hotels, restaurants, tables, etc
- Made from pressure die cast aluminium alloy
- AISI 304 stainless steel plated motor body
- Speed reducer with oil immersed gears
- Italian make asynchronous motor - Thermal protection
- Easy-removable "ENTERPRISE" mincing unit available in:
 - a) Electroless nikel plated cast iron (MOD.12-22)
 - b) Anodized aluminium (MOD. 8/12/22)
 - c) AISI 304 stainless steel (MOD. 8-12-22)
- Stainless steel self-sharpening draw-plates included
- Gear inversion option available
- Loading meat inlet dimensions: 120x52 mm
- Output mouth dimensions: mod.8/Ø 60 mm. - mod.12/Ø 70 mm. - mod.22/Ø 82 mm.
- Stainless steel tray and hopper
- Stainless steel grating roll plated with nikel electroless
- AISI 304 roll option is also available - Stainless steel cheese bowl
- Safety Stainless steel protection grid placed at the bottom of the grating mouth
- Safety micro switch placed on the mouth inlet
- ABS pestle - 24 volt controls (FOR CE MODELS ONLY)
- Model TG18 is recommended for home use and small business use
- Proudly Made in Italy



GHISA / CAST IRON



INOX / STAINLESS STEEL

gruppo di macinazione modello ENTERPRISE, altri gruppi di macinazione disponibili a pag. 054
mincing groups ENTERPRISE model, other mincing groups available at page 054

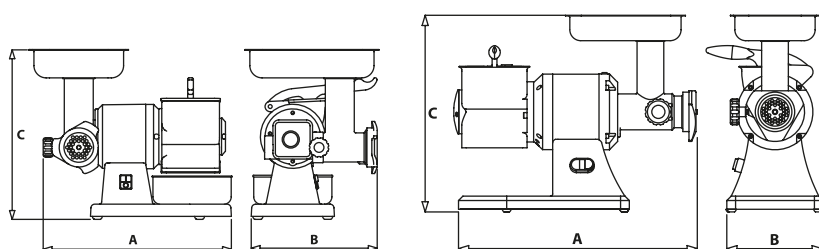

	A	B	C	Alimentazione Power supply	Potenza Motor power	Giri/m tritacarne Meat mincer RPM	Giri/m grattugia Grater RPM	Produzione oraria tritacarne Meat mincer production per hour	Produzione oraria grattugia Grater production per hour	Bocca tritacarne Meat mincer mouth	Bocca grattugia Grater mouth	Piastra in dotazione Standard plate	Peso netto mono/tri fase Net weight single/three-phase	Dimensioni imballo Packing dimensions	Peso lordo mono/tri fase Gross weight single/three-phase
	mm	mm	mm	Volt/Hz	Kwatt/Hp			kg	kg	mm	mm	mm	kg	mm	kg
TG8	380	260	360	230/50	0,38 (0,50)	80	1400	20	30	Ø60	110x65	Ø 6	10,0	380x310x360	11,0
TG12	550	200	460	230/50 - 230-400/50	0,75 (1,00)	200	1400	200	50	Ø70	140x80	Ø 6	22,0/20,0	590x300x430	24,5/22,5
TG22	610	220	460	230/50 - 230-400/50	1,10 (1,50)	140	900	300	70	Ø82	140x80	Ø 6	27,0/25,0	720x290x440	30,0/28,0



TRITACARNE E GRATTUGIA CARENATO SERIE TGI

FAIRED COMBO MEAT MINCER AND GRATER TGI MODELS



TGI12

GRUPPI DI MACINAZIONE / MINCING GROUPS

	Inox S/Steel	Alluminio Aluminium	Ghisa Cast Iron
TGI8	●	●	
TGI12	●	●	●
TGI22	●	●	●



TGI8



TGI12



TGI22

- Apparecchio per uso professionale
- Ideale per ristoranti, alberghi, mense
- Struttura in lamiera di acciaio inox AISI 304
- Sistema di riduzione ad ingranaggi elicoidali a bagno d'olio
- Motore asincrono produzione nazionale
- Termica di protezione
- Gruppo macinazione carne "enterprise" asportabile disponibile in:
 - a) Ghisa alimentare (12-22) trattamento electroless nikel plating
 - b) Alluminio anodizzato (8 -12-22)
 - c) Acciaio inossidabile AISI 304 (8 -12-22)
- Trafilte auto affilanti in acciaio inox di serie
- Disponibile con inversione di marcia
- Dimensione alimentazione 120 x 52 mm
- Dimensione scarico 8/60 mm 12/70 mm 22/82 mm
- Tramoggia e piatto raccolta prodotto in acciaio inox
- Rullo in acciaio con trattamento electroless nikel plating
- Scodella forma in acciaio inox
- Grata di protezione allo scarico bocca grattugia inox
- Micro di protezione alla grattugia
- Pestello in ABS - Comandi a 24 volt (solo versione CE)
- Versione TGI 8 consigliato per uso domestico e piccole attività
- Produzione italiana

- Professional equipment
- Ideally suited for hotels, restaurants, tables, etc
- AISI 304 stainless steel plated case
- Speed reducer with oil immersed gears
- Italian make asynchronous motor
- Thermal protection
- Easy-removable "ENTERPRISE" mincing unit available in:
 - a) Electroless nikel plated cast iron (MOD. 12-22)
 - b) Anodized aluminium (MOD. 8/12/22)
 - c) AISI 304 stainless steel (MOD. 8-12-22)
- Stainless steel self-sharpening draw-plates included
- Gear inversion option available
- Loading meat inlet dimensions: 120x52 mm
- Output mouth dimensions:
 - mod. 8/Ø 60 mm. - mod.12/Ø 70 mm. - mod. 22/Ø 82 mm.
- Stainless steel tray and hopper
- Stainless steel grating roll plated with nikel electroless
- Stainless steel cheese bowl
- Safety Stainless steel protection grid placed at the bottom of the grating mouth
- Safety micro switch placed on the mouth inlet
- ABS pestle- 24 volt controls (FOR CE MODELS ONLY)
- Model TGI 8 is recommended for home use and small business use
- Proudly Made in Italy

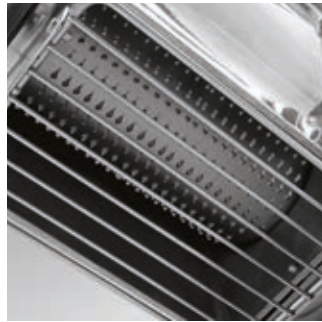

GHISA / CAST IRON



INOX / STAINLESS STEEL

gruppo di macinazione modello ENTERPRISE, altri gruppi di macinazione disponibili a pag. 054
 mincing groups ENTERPRISE model, other mincing groups available at page 054

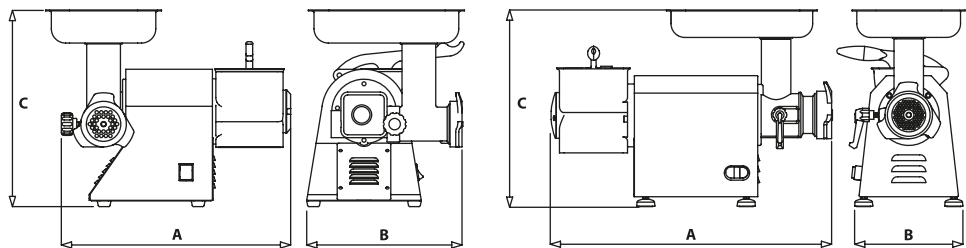

	A	B	C	Alimentazione Power supply	Potenza Motor power	Gir/rim tritacarne Meat mincer RPM	Gir/rim grattugia Grater RPM	Produzione oraria tritacarne Meat mincer production per hour	Produzione oraria grattugia Grater production per hour	Bocca tritacarne Meat mincer mouth	Bocca grattugia Grater mouth	Piastra in dotazione Standard plate	Peso netto mono/tri fase Net weight single/three phase	Dimensioni imballo Packing dimensions	Peso lordo mono/tri fase Gross weight single/three phase
	mm	mm	mm	Volt/Hz	Kwatt/Hp			kg	kg	mm	mm	mm	kg	mm	kg
TGI 8	400	280	360	230/50	0,38 (0,50)	80	1400	20	30	ø60	110x65	ø 6	12,0	380x310x360	13,0
TGI 12	590	220	440	230/50 - 230-400/50	0,75 (1,00)	200	1400	200	50	ø70	140x80	ø 6	25,0/23,0	720x290x440	28,0/26,0
TGI 22	610	220	440	230/50 - 230-400/50	1,10 (1,50)	140	900	300	70	ø82	140x80	ø 6	28,0/26,0	720x290x440	31,0/29,0



TRITACARNE E GRATTUGIA SERIE UNIKO ENTERPRISE

COMBO MEAT MINCER AND GRATER UNIKO ENTERPRISE MODELS



TGK12



INOX / STAINLESS STEEL

gruppo di macinazione modello ENTERPRISE, altri gruppi di macinazione disponibili a pag. 054
mincing groups ENTERPRISE model, other mincing groups available at page 054



GRUPPI DI MACINAZIONE / MINCING GROUPS

	Inox S/Steel	Alluminio Aluminium	Ghisa Cast Iron
TG18	●	●	
TG12	●	●	●
TG122	●	●	●



TGK12



TGK22



TGIK12

- Apparecchio per uso professionale
- Ideale per ristoranti, alberghi, mense
- Corpo in lega di alluminio pressofuso (TGK)
- Struttura in lamiera di acciaio inox (TGIK)
- Sistema di riduzione ad ingranaggi elicoidali a bagno d'olio
- Robusto motore asincrono di produzione nazionale
- Termica di protezione
- Gruppo macinazione carne "enterprise" asportabile in acciaio inox AISI 304
- Trafile auto affilanti in acciaio inox di serie
- Versione CE disponibile con inversione di marcia
- Dimensioni alimentazione 52mm per 120 mm
- Dimensione scarico 12/70 mm 22/82 mm
- Tramoggia e piatto raccolta prodotto in acciaio inox
- Pestello in ABS
- Micro di protezione alla bocca grattugia
- Grata in acciaio inox allo scarico della grattugia
- Comandi a 24 volt
- Produzione italiana

- Professional equipment
- Ideally suited for hotels, restaurants, tables, etc
- Pressure die cast aluminium alloy cover casing (TGK)
- Structured in stainless steel plating (TGIK)
- Speed reducer with oil immersed gears
- Heavy duty Italian make asynchronous motor
- Thermal protection
- AISI 304 stainless steel easy-removable "ENTERPRISE" mincing unit
- Stainless steel self-sharpening draw-plates included
- Gear inversion option available on the CE models
- Loading meat inlet dimensions: 120x52 mm
- Output mouth dimensions: mod.12/Ø 70 mm. - mod.22/Ø 82 mm
- Stainless steel tray and hopper
- ABS pestle
- Safety micro switch placed on the mouth inlet
- Safety Stainless steel protection grid placed at the bottom of the grating mouth
- 24 volt controls
- Proudly Made in Italy

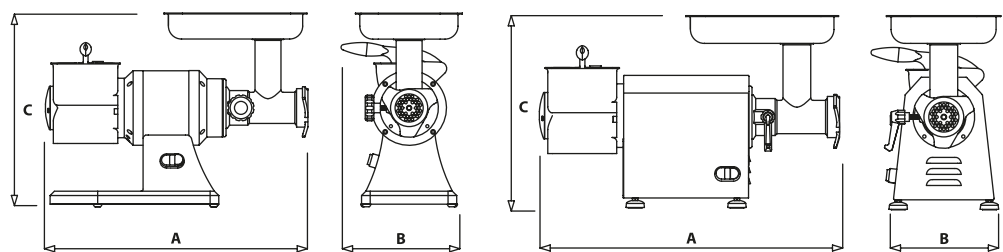

	A	B	C	Alimentazione Power supply	Potenza Motor power	Giri/m tritacarne Meat mincer RPM	Giri/m grattugia Grater RPM	Produzione oraria tritacarne Meat mincer production per hour	Produzione oraria grattugia Grater production per hour	Bocca tritacarne Meat mincer mouth	Bocca grattugia Grater mouth	Plastra in dotazione Standard plate	Peso netto mono/tri fase Net weight single/three phase	Dimensioni imballo Packing dimensions	Peso lordo mono/tri fase Gross weight single/three phase
	mm	mm	mm	Volt/Hz	Kwatt/Hp			kg	kg	mm	mm	mm	kg	mm	kg
TGK 12	610	220	470	230/50 - 230-400/50	0,75 (1,00)	200	1400	200	50	Ø70	140x80	Ø 6	25/23	720x290x440	28,0/26,0
TGK 22	670	240	500	230/50 - 230-400/50	1,10 (1,50)	140	900	300	70	Ø82	140x80	Ø 6	29/27	720x290x440	32,0/30,0
TGIK 12	640	220	430	230/50 - 230-400/50	0,75 (1,00)	200	1400	200	50	Ø70	140x80	Ø 6	26/24	720x290x440	28,0/26,0
TGIK 22	660	220	430	230/50 - 230-400/50	1,10 (1,50)	140	900	300	70	Ø82	140x80	Ø 6	29/27	720x290x440	32,0/30,0



TGIK22





MOD. 12



MOD. 22



MOD. 12/22

- Accessori complementari per uso professionale
- Ideali per ristoranti e comunità
- Corpo Passa pomodoro in alluminio
- Passino in acciaio inox
- Elica in ghisa alimentare o alluminio
- Struttura passa purea in alluminio
- Perni e innesti realizzati in acciaio tornito
- Rapido sistema di fissaggio al corpo macchina
- Tramoggia e piatto raccolta prodotto in acciaio inox
- Pestello in ABS
- Facile da montare, smontare e pulire
- Produzione italiana

- *Optional tools for professional use*
- *Ideally suited for restaurants, large community*
- *Aluminium tomato juicer casing*
- *S/steel strainer*
- *Screw available in cast iron or aluminium*
- *Puree tool structured in aluminium*
- *Turned steel pins and clutches*
- *Easy machine body locking*
- *Stainless steel hopper and tray*
- *ABS pestle*
- *Easy to assemble, disassemble and clean*
- *Proudly Made in Italy*

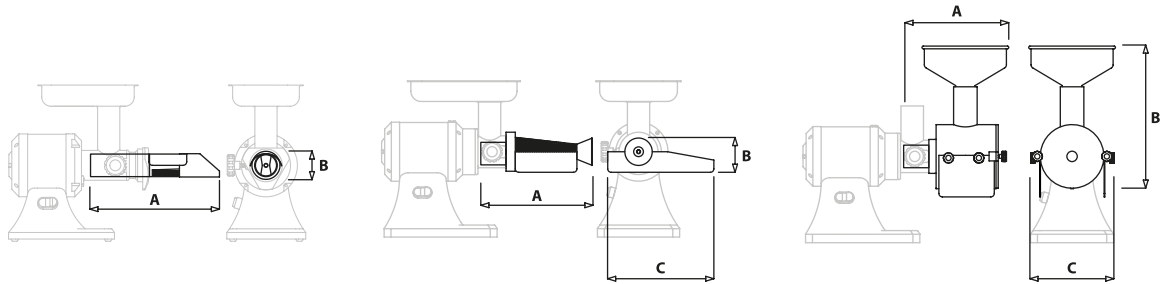

	A	B	C	Peso netto Net weight	Dimensioni imballo Packing dimensions
	mm	mm	mm	kg	mm
PASSAPOM. MOD. 12	340	ø75	---	1,3	280x280x140
PASSAPOM. MOD. 22	350	ø120	290	3,5	310x260x370
PASSAPUREA MOD. 12	330	400	230	5,5	380x310x360
PASSAPUREA MOD. 22	330	400	230	5,5	380x310x360





Piadina Romagnola / Piadina Romagnola

Emilia Romagna



Preparazione / Directions

Mescolare tutti gli ingredienti con l'acqua o il latte fino ad ottenere un impasto abbastanza sodo senza lavorarlo troppo per evitare bolle durante la cottura, lasciare riposare per un'ora ricoprendo con uno strofinaccio pulito. Fare delle pagnotte, distenderle con un matterello e formare delle piade di circa 25 cm di diametro e spessore molto basso. Strofina il mattarello con della farina per evitare che l'impasto si attacchi. Cuocere la piada su di una teglia in ghisa per poco tempo fino a farla dorare: mentre la cottura procede in superficie si formano delle bolle medio-piccole più scure che conferiscono l'aspetto caratteristico. Bucare entrambe le superfici della piadina con una forchetta per migliorare la cottura interna. Durante la cottura voltare spesso la piadina. Affettare salumi e formaggi a piacere e riporli dentro la piadina piegata.

Combine the flour, olive oil and salt in a bowl. Mix a little by hand until you have an evenly crumbly mixture, then begin to pour in the water, little by little, until you have a soft, pliable dough that's not sticky or dry. minutes). Leave the ball of dough to rest for 30 minutes under a tea towel or wrapped in plastic wrap. When ready, it should be as elastic, soft, and smooth. Cut into portions. Roll out on a lightly floured surface until about 2 millimeters thick (or up to 3 millimeters or 1/10 inch) and roughly 25 centimeters (10 inches) wide. Heat a flat nonstick or cast-iron skillet over medium heat and when hot, cook one piadina at a time, about 2 to 3 minutes on each side, or until bubbles begin to appear on the surface. Poke the bubbles with a fork to let the air escape, and then flip over. Transfer the cooked piadina to a plate and then fill them with your chosen fillings (classic examples are prosciutto and Stracchino cheese), fold in half, then heat again on a hot skillet until the fillings are warm. Serve immediately.



INGREDIENTI / INGREDIENTS

1 Kg di farina tipo "0"
150 gr. di strutto
Un pizzico di sale
Acqua o latte quanto basta
(usare il latte per ottenere una piada più morbida)
Salumi e formaggi da affettare a piacere per la farcitura

1 Kg flour type "0"
150 gr. lard
A pinch of salt
Water or milk to taste
(use the milk to achieve a softer piadina)
Cold cuts and cheeses to slice for the stuffing



SERIE RETRÒ MIGNON

RETRÒ MIGNON MODELS

TS 8 R



TS 8 R



TG 8 R



GM R

- Apparecchi per uso semiprofessionale e domestico
- Ideale per abitazioni e piccoli ristoranti,
- Corpo in lega di alluminio pressofuso e verniciato
- Sistema di riduzione ad ingranaggi elicoidali a bagno d'olio
- Robusto motore a induzione di produzione nazionale
- Termica di protezione
- Gruppo macinazione carne "enterprise" asportabile in alluminio o in acciaio inox
- Dimensioni carico tritacarne 52x120 mm
- Dimensioni scarico tritacarne 60 mm
- Traffle auto affilanti in acciaio inox di serie
- Tramoggia in acciaio inox
- Rullo grattugia in acciaio
- Disponibile in AISI 304
- Micro di protezione al carico della bocca grattugia
- Grata di protezione allo scarico della bocca grattugia in acciaio inox
- Scodella raccolta formaggio inox
- Pestello in ABS
- Comandi a 24 volt
- Produzione italiana

- Household and semi-professional equipment
- Ideally suited for the small restaurants and home use
- Pressure die cast aluminium alloy and varnished case
- Speed reducer with oil immersed gears
- Italian make heavy duty induction motor
- Thermal protection
- Easy-removable "ENTERPRISE" mincing unit available in stainless steel or aluminium
- Loading meat inlet dimensions: 52x120 mm
- Output mouth dimensions: 60 mm
- Stainless steel self-sharpening draw-plates
- Stainless steel hopper
- Stainless steel grating roll
- AISI 304 option is also available
- Safety micro switch placed on the mouth inlet
- Safety Stainless steel protection grid placed at the bottom of the grating mouth
- Stainless steel cheese bowl
- ABS pestle
- 24 volt controls
- Proudly Made in Italy



gruppo di macinazione modello ENTERPRISE 8 INOX, altri gruppi di macinazione disponibili a pag. 054
mincing groups ENTERPRISE 8 S/STEEL model, other mincing groups available at page 054

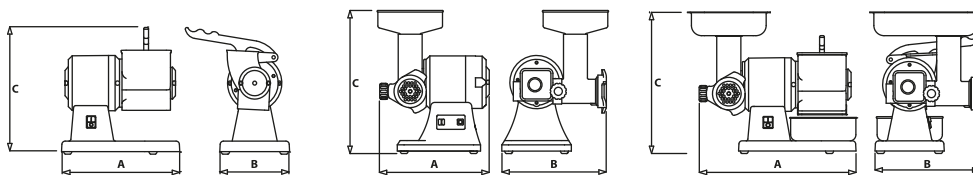

	A	B	C	Alimentazione Power supply	Potenza Power	Giri/m tritacarne Meat mincer RPM	Giri/m grattugia Grater RPM	Produzione oraria tritacarne Meat mincer production per hour	Produzione oraria grattugia Grater production per hour	Bocca tritacarne Meat mincer mouth	Bocca grattugia Grater mouth	Plastria in dotazione Standard plate	Peso netto mono/tri fase Net weight single/three phase	Dimensioni imballo Packing dimensions	Peso lordo mono/tri fase Gross weight single/three phase
	mm	mm	mm	Volt/Hz	Kwatt/Hp			kg	kg	mm	mm	mm	kg	mm	kg
TS 8 R	270	260	360	230/50	0,38 (0,50)	80	---	20	---	ø60	---	ø 6	12,0	410x310x410	13,0
TG 8 R	380	260	360	230/50	0,38 (0,50)	80	1400	20	30	ø60	110x65	ø 6	10,0	390x300x370	11,0
GM R	280	170	310	230/50	0,38 (0,50)	---	1400	---	30	---	110x65	---	8,0	300x260x360	9,0



TS 12 R



gruppo di macinazione modello ENTERPRISE 8 INOX,
altri gruppi di macinazione disponibili a pag. 054
*mincing groups ENTERPRISE 8 S/STEEL model,
other mincing groups available at page 054*



TS 12 R



TG 12 R



GS R

- Apparecchi per uso professionale
- Ideale per ristoranti e macellerie in "stile"
- Corpo in lega di alluminio pressofuso e verniciato
- Sistema di riduzione ad ingranaggi elicoidali a bagno d'olio
- Robusto motore a induzione di produzione nazionale
- Termica di protezione
- Gruppo macinazione carne "enterprise" asportabile
- In ghisa alimentare o acciaio inox
- Dimensioni carico tritacarne 52x120 mm
- Dimensioni scarico tritacarne 70 mm
- Trafile auto affilanti in acciaio inox di serie
- Tramoggia in acciaio inox
- Rullo grattugia in acciaio
- Disponibile in AISI 304
- Micro di protezione al carico della bocca grattugia
- Grata di protezione allo scarico della bocca grattugia in acciaio inox
- Scodella raccolta formaggio inox
- Pestello in ABS
- Comandi a 24 volt
- Produzione italiana

- Professional equipment
- Particularly suitable for "stylish" restaurants and butcheries
- Pressure die cast aluminium alloy and varnished case
- Speed reducer with oil immersed gears
- Italian make heavy duty induction motor
- Thermal protection
- Easy-removable "ENTERPRISE" mincing unit
- Available in cast iron or stainless steel
- Loading meat inlet dimensions: 52x120 mm
- Output mouth dimensions: 70 mm
- Stainless steel self-sharpening draw-plates
- Stainless steel hopper
- Stainless steel grating roll
- AISI 304 option is also available
- Safety micro switch placed on the mouth inlet
- Safety Stainless steel protection grid placed at the bottom of the grating mouth
- Stainless steel cheese bowl
- ABS pestle
- 24 volt controls
- Proudly Made in Italy

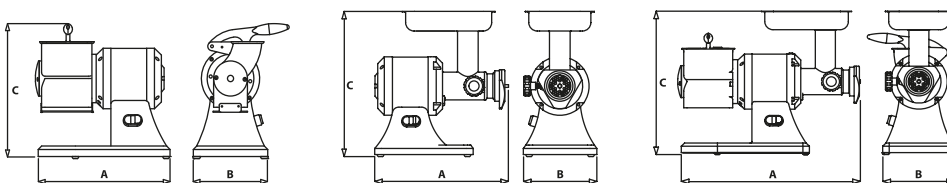

	A	B	C	Alimentazione Power supply	Potenza Motor power	Giri/m tritacarne Meat mincer RPM	Giri/m grattugia Grater RPM	Produzione oraria tritacarne Meat mincer production per hour	Produzione oraria grattugia Grater production per hour	Bocca tritacarne Meat mincer mouth	Bocca grattugia Grater mouth	Plastra in dotazione Standard plate	Peso netto mono/tri fase Net weight single/three phase	Dimensioni imballo Packing dimensions	Peso lordo mono/tri fase Gross weight single/three phase
	mm	mm	mm	Volt/Hz	Kwatt/Hp			kg	kg	mm	mm	mm	kg	mm	kg
TS 12 R	370	220	440	230/50 - 230-400/50	0,75 (1,00)	200	---	200	---	ø70	---	ø6	19,0	460x250x370	21,0
TG 12 R	550	220	460	230/50 - 230-400/50	0,75 (1,00)	200	1400	200	50	ø70	140x80	ø6	22,0	600x290x430	25,0
GS R	380	220	380	230/50 - 230-400/50	0,75 (1,00)	---	1400	---	50	---	140x80	---	18,0	400x310x400	20,0



AFFETTATRICI A VOLANO

- Struttura in lega di alluminio con fusione in conchiglia per garantire una durata nel tempo ed elevata affidabilità
- Superficie verniciata a "fuoco" per ottenere una lucentezza ed un'igiene ottimali
- Affilatoio superiore di serie e di facile utilizzo
- Spessore di taglio da 0 a 2 mm
- Anello paralama fisso

- Heavy structure with aluminium with chilled casting to grant life and a good reliability
- Fire painted surface to get a sheen and optimum hygiene
- Upper sharpener standard and easy to use
- Cutting thickness from 0 to 2 mm
- Fixed blade protecting ring



250 R



300 R

	A	B	C	Ø Lama Ø Blade size	Capacità di taglio Cutting capacity	Peso netto Net weight	Dimensioni imballo Packing dimensions
	mm	mm	mm	mm	mm	kg	mm
250R AFFETTATRICE A VOLANO	520	680	510	250	185x150	33,0	850x750x850
250R AFFETTATRICE + BASE A COLONNA	520	680	1260	250	185x150	78,0	Pallet 800x1200
300R AFFETTATRICE A VOLANO	755	580	520	300	230x300	40,0	600x900x700
300R AFFETTATRICE + BASE A COLONNA	755	610	1270	300	230x300	85,0	Pallet 800x1200

- Apparecchio per uso professionale
- Per bar, ristoranti, piccole comunità
- Macchina realizzata in lega di alluminio
- Motore asincrono ventilato
- Lama di produzione nazionale
- Anello di protezione
- Boccole carrello autolubrificanti
- Versione CE con blocco al carrello
- Supporto vela maggiorato
- Ampio piatto porta salumi
- Protezione in plastica al carrello
- Curata nei dettagli
- Trasmissione a cinghia
- Affilatoio incorporato
- Corsa carrello maggiorata (mod. 250)

- Professional equipment
- Ideally suited for the small hotel, pub, snack bar, café, club etc
- Slicer made from highly food-grade aluminium
- Ventilated asynchronous motor
- Italian made blades
- Safety ring
- Permanently lubricated carriage ball bearings
- CE MODELS with carriage locking option
- Capacious food plate
- Safety carriage plastic cover
- High quality gravity feed slicer
- Belt transmission
- Sharpening accessory included

220 R

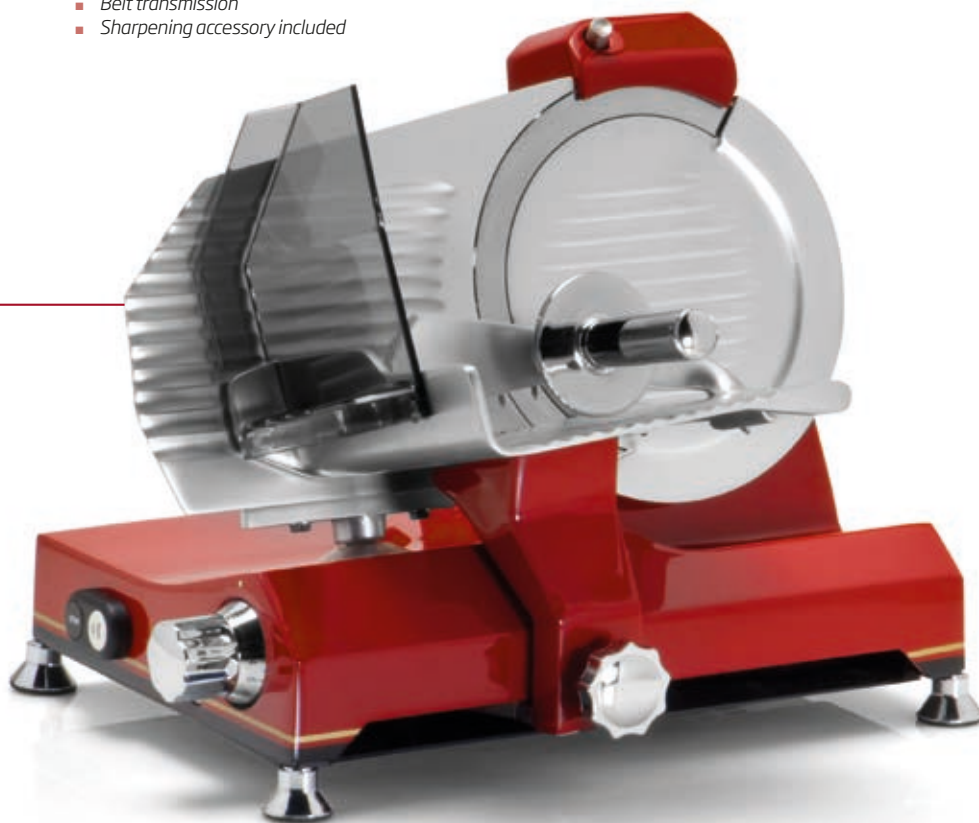

	Ø Lama Ø Blade size	A	B	C	D	E	Corsa carrello Carriage sliding	Cap. taglio Cutting capacity	Spessore taglio Slice thickness	Alimentazione Power supply	Potenza Motor power	Peso netto Net weight	Dimensioni imballo Packing dimensions
	mm	mm	mm	mm	mm	mm	mm	mm	mm	Volt/Hz	Kwatt/Hp	kg	mm
220 R	220	400	450	370	420	330	240	170x210	14,0	230/50	0,25 (0,35)	13,0	560x470x460
250 R	250	400	500	400	420	330	260	190x250	14,0	230/50	0,25 (0,35)	19,0	560x470x460



250 R

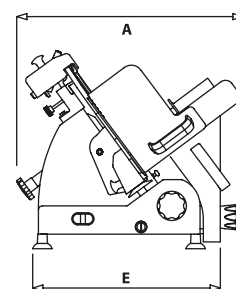
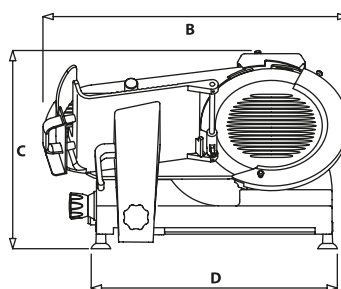



AFFETTATRICI RETRÒ GRAVITÀ Serie 275 300 330 350

RETRÒ GRAVITY MEAT SLICER 275 300 330 350 MODELS

275 GR



300 GR



330 GR



350 GR

275 300

- Macchine per uso professionale
- Destinate a macellerie, comunità, hotel, alberghi, ristoranti
- Fusione in lega di alluminio anodizzato
- Motore asincrono ventilato
- Lama forgiata di produzione nazionale
- Anello di protezione alla lama
- Boccole carrello autolubrificanti
- Blocco al carrello come da normativa
- Supporto vela maggiorato
- Ampio piatto porta salumi
- Curata nei dettagli
- Priva di spigoli
- Protezione in plastica al carrello
- Trasmissione con robusta cinghia in poliester
- Scheda elettrica a 24 volt
- Interruttore digitale
- Affilatoio incorporato
- Norme CE
- Fabbricata in Italia

- Professional equipment
- Ideally suited for hotel, pub, snack bar, café, club, restaurants, butcheries, etc
- Made from highly polished anodised food-grade aluminium
- Ventilated asynchronous motor
- Italian make forged blade
- Blade safety ring
- Permanently lubricated carriage ball bearings
- CE approved carriage
- Capacious food plate
- High quality gravity feed slicer
- No Sharp corners slicer
- Safety carriage plastic cover
- Powerful polyester belt driven transmission
- 24 volt. Low tension card
- Digital ON/OFF switch
- Sharpening accessory included
- CE approved
- Proudly Made in Italy

330 350

- Macchine affetta salumi professionali
- Destinate a macellerie, supermarket, grandi comunità
- Fusione in lega di alluminio anodizzato
- Motore asincrono ventilato
- Lama tornita di produzione nazionale
- Anello di protezione alla lama
- Boccole carrello autolubrificanti
- Blocco al carrello come da normativa
- Protezione al carrello in plexiglas
- Supporto vela maggiorato
- Vela spessore 15mm. (unica in Italia)
- Ampio piatto porta salumi
- Priva di spigoli
- Curata nei dettagli
- Trasmissione a cinghia in poliester
- Affilatoio incorporato
- Norme CE
- Fabbricata in Italia

- Professional equipment
- Ideally suited for butcheries, supermarkets, etc
- Heavy duty slicer made from highly polished anodised food-grade aluminium
- Ventilated asynchronous motor
- Italian make turned blade
- Blade safety ring
- Permanently lubricated carriage ball bearings
- CE approved carriage locking
- Safety carriage plexiglass cover
- 15 mm. fence thickness (sole in Italy)
- Capacious feeding pan
- No Sharp corners slicer
- High quality gravity feed slicer
- Powerful polyester belt driven transmission
- Sharpening accessory included
- CE approved
- Proudly Made in Italy

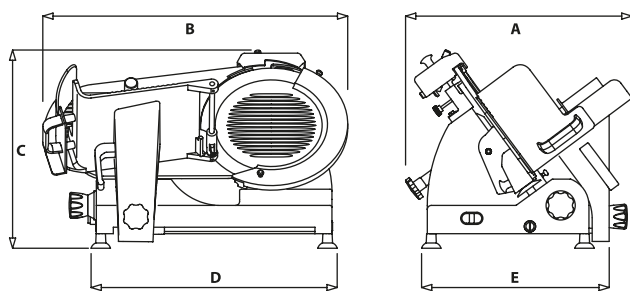

	Ø Lama Ø Blade size	A	B	C	D	E	Goncia carrello Carriage sliding	Cap. taglio Cutting capacity	Spessore taglio Slice thickness	Alimentazione Power supply	Potenza Motor power	Peso netto Net weight	Dimensioni imballo Packing dimensions
	mm	mm	mm	mm	mm	mm	mm	mm	mm	Volt/Hz	Kwatt/Hp	kg	mm
275 GR	275	500	630	420	470	320	270	230x160	15,0	230/50 - 230-400/50	0,27 (0,35)	22,0	650x570x520
300 GR	300	500	630	420	470	320	270	230x160	15,0	230/50 - 230-400/50	0,27 (0,35)	23,0	650x570x520
330 GR	330	500	780	480	600	420	330	240x250	15,0	230/50 - 230-400/50	0,38 (0,50)	38,0	800x700x620
350 GR	350	500	800	480	600	420	330	240x250	15,0	230/50 - 230-400/50	0,38 (0,50)	40,0	800x700x620



MODELLI TRITACARNE ENTERPRISE / ENTERPRISE MEAT MINCER

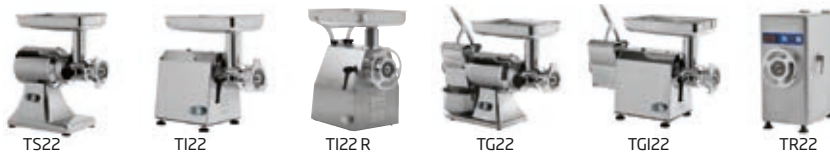

MODELLI TRITACARNE UNIKO ENTERPRISE / UNIKO ENTERPRISE MEAT MINCER



MODELLI TRITACARNE UNGER / UNGER SYSTEM MEAT MINCER



MOD.	INOX / S/STEEL	ALLUMINIO / ALUMINIUM	GHISA / CAST IRON
------	----------------	-----------------------	-------------------



MOD.	INOX / S/STEEL	ALLUMINIO / ALUMINIUM	GHISA / CAST IRON
------	----------------	-----------------------	-------------------



MOD.	INOX / S/STEEL	ALLUMINIO / ALUMINIUM	GHISA / CAST IRON
------	----------------	-----------------------	-------------------

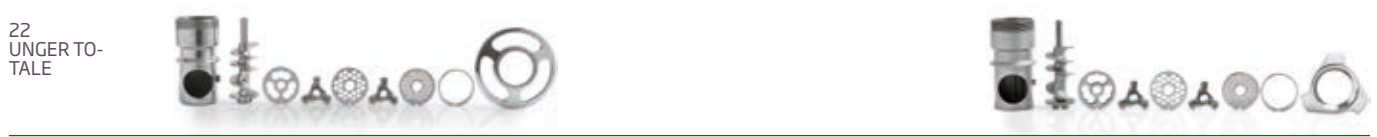



Passatelli in brodo / *Passatelli soup*

Marche



Preparazione / *Directions*

Preparare il brodo di carne cuocendo per 2 ore un pezzo di carne di manzo, la costa di sedano, la carota, 1 una piccola cipolla e 1 pomodoro in 4 litri di acqua. Sgusciare le uova dentro ad una ciotola e sbatterle. Aggiungere il pangrattato, il parmigiano grattugiato, sale, pepe, la noce moscata e scorza di limone grattugiata. Amalgamare gli ingredienti fino ad ottenere un composto compatto ma elastico; aggiungere un po' di brodo per ammorbidirlo oppure nel caso contrario aggiungere del pangrattato. Lasciare riposare 5 minuti, prendere un po' di impasto e pressarlo nello schiacciapatate avendo utilizzando il disco a fori larghi. Tagliare con un coltello i passatelli a circa 6 cm di lunghezza e adagiarli su di un panno pulito senza sovrapporli; fare bollire il brodo e versarvi dentro i passatelli. Quando i passatelli verranno a galla toglierli dalla pentola e porli in un piatto fondo con del brodo; servire con una spolverata di parmigiano grattugiato.

Passatelli are a classic specialty of the Marche, made with a cup-and-plunger-like device that forces dough through a plate with 1/4-inch diameter holes in it, thus forming strings that are called passatelli. Melt the beef marrow over a low flame. In a bowl, combine the breadcrumbs, cheese, eggs, melted marrow, and nutmeg. The resulting dough should be fairly firm; if it is not, add some more breadcrumbs. If it is ridged, soften it with a little white wine. Let the dough rest for a half hour, and in the meantime bring the broth to a boil. Fill your passatelli iron or potato ricer with the dough and squeeze it over the simmering broth, allowing the passatelli to drop into it. As soon as the passatelli have risen to the surface turn off the flame and let the soup sit for a few minutes. Pour the passatelli into a tureen, sprinkle some more cheese and serve them.



INGREDIENTI / *INGREDIENTS*

300 g carne di manzo
per il brodo
1 costa di sedano
1 carota
1 una piccola cipolla
1 pomodoro
5 uova

150 g parmigiano grattugiato
300 g pangrattato
100 g farina
Sale
Noce moscata
Pepe
Scorza di limone

300 g beef for broth
1 celery
1 carrot
1 small onion
1 tomato
5 eggs

150 g grated parmesan
300 g breadcrumbs
100 g flour
Salt
Nutmeg
Pepper
Lemon rind

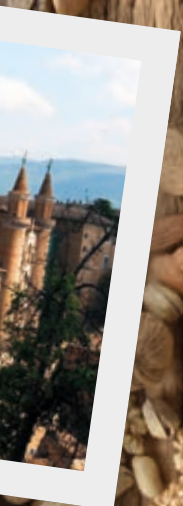



GRATTUGIE

GRATERS

GSM

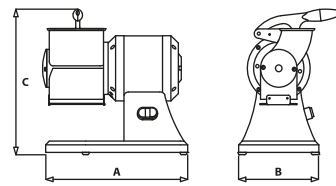
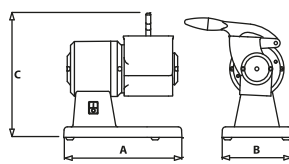
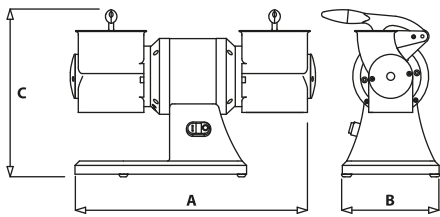

GS



GSD



GSM

GD

- Apparecchi per uso professionale
- Ideale per supermarket e grandi comunità
- Struttura in alluminio pressofuso lucidato o verniciato
- Motore asincrono ventilato di grande potenza
- Micro interruttore alla parte grattugia
- Rullo in acciaio inossidabile
- Grata di protezione allo scarico in acciaio inox
- Termica di protezione al motore
- Scodelle raccolta forma in acciaio inox
- Versione GG indicata esclusivamente per grandi produzioni
- Versione GG scodella raccolta forma in plastica
- Norme CE
- Fabbricato in Italia

- Professional equipment
- Ideally suited for supermarkets and intensive work
- Structured in pressure die cast polished or varnished aluminium
- Powerful Ventilated asynchronous motor
- Safety micro switch
- Stainless steel grating roll
- Stainless steel grid to avoid contact with moving parts
- Thermal overload protection
- Stainless steel cheese bowl
- GG model recommended for intensive use only
- GG model comes with plastic cheese bowl
- CE approved
- Proudly Made in Italy

GSM GS GSD GMR GMB GM

- Apparecchi per uso professionale
- Ideale per ristoranti, alberghi, hotel, supermarket, comunità
- In grado di lavorare grandi quantità di prodotto
- Struttura in alluminio pressofuso lucidato
- Fascia in acciaio inox lucidato sulla carcassa motore
- Motore asincrono ventilato di grande potenza e durata
- Termica di protezione al motore
- Freno motore su modelli GS e GSM
- Micro meccanico all'apertura della carico grattugia
- Rullo grattugia in acciaio con trattamento (electroless nickel plating) certificato
- Disponibile rullo grattugia in acciaio inox AISI 304
- Grata di protezione allo scarico in acciaio
- Versione GM consigliata per uso domestico e piccole attività
- Norme CE
- Fabbricato in Italia

- Professional equipment
- Ideally suited for restaurants, hotels, supermarkets, etc
- Heavy duty grater
- Structured in pressure die cast polished aluminium
- Polished stainless steel motor band
- Powerful ventilated asynchronous motor
- Thermal overload protection
- Motor brake available on GS and GSM model
- An interlock is assembled on the cheese pressing handle; It is started when the cheese load safety threshold is exceeded to avoid contact with the moving cutting part
- Special steel roll plated with electroless nickel
- Aisi 304 stainless steel roll option available
- The grater has a special stainless steel
- Grid to avoid contact with moving parts
- Model GM is recommended for home use and small business use
- Ce approved
- Proudly Made in Italy

	A mm	B mm	C mm	Alimentazione Power supply Volt/Hz	Potenza Motor power Kwatt/Hp	Giri/m grattugia Grater RPM	Produzione oraria grattugia Grater production per hour kg	Bocca grattugia Grater mouth mm	Peso netto mono/tri fase Net weight single/three phase kg	Dimensioni imballo Packing dimensions mm	Peso lordo mono/tri fase Gross weight single/three phase kg
GSM	420	220	380	230/50 - 230-400/50	1,10 (1,50)	900	90	140x80	20,0	470x300x520	22,0
GD	540	220	380	230/50 - 230-400/50	0,75 (1,00)	1400	70	140x80	21,0	470x300x520	24,0
GS	540	220	380	230/50 - 230-400/50	0,75 (1,00)	1400	70	140x80	18,0	400x310x400	20,0
GSD	380	220	380	230/50 - 230-400/50	0,75 (1,00)	1400	70	140x80	18,0	400x310x400	20,0
GM	280	170	310	230/50	0,38 (0,50)	1400	30	110x65	8,00	300x260x360	9,00



GD



GMR



GMB



GM



GG HP2



GG HP2



GG HP4

GG2HP GG4HP

- Apparecchi per uso professionale
 - Ideale per supermarket e grandi comunità
 - Struttura in alluminio pressofuso lucidato o verniciato
 - Motore asincrono ventilato di grande potenza
 - Freno motore
 - Micro interruttore alla parte grattugia
 - Rullo in acciaio inossidabile
 - Grata di protezione allo scarico in acciaio inox
 - Termica di protezione al motore
 - Scodella raccolta forma in acciaio inox
 - Versione GG indicata esclusivamente per grandi produzioni
 - Versione GG scodella raccolta forma in plastica
 - Norme CE
 - Fabbricato in Italia
- Professional equipment
 - Ideally suited for supermarkets and intensive work
 - Structured in pressure die cast polished or varnished aluminium
 - Powerful Ventilated asynchronous motor
 - Motor brake
 - Safety micro switch
 - Stainless steel grating roll
 - Stainless steel grid to avoid contact with moving parts
 - Thermal overload protection
 - Stainless steel cheese bowl
 - GG model recommended for intensive use only
 - GG model comes with plastic cheese bowl
 - CE approved
 - Proudly Made in Italy

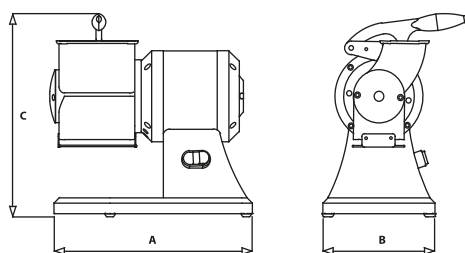

	A	B	C	Alimentazione Power supply	Potenza Motor power	Giri/grattugia Grater RPM	Produzione oraria grattugia Grater production per hour	Bocca grattugia Grater mouth	Peso netto mono/tri fase Net weight single/three phase	Dimensioni imballo Packing dimensions	Peso lordo mono/tri fase Gross weight single/three phase
	mm	mm	mm	Volt/Hz	Kwatt/Hp	kg	kg	mm	kg	mm	kg
GG HP2	500	280	570	230/50 - 230-400/50	1,5 (2,00)	1400	100	180x110	30,0	750x480x640	34,0
GG HP4	700	400	600	230/50 - 230-400/50	3,00 (4,00)	1400	120	285x150	40,0	850x570x750	44,0





Pesto alla genovese / *Genovese pesto sauce*

Liguria



Preparazione / *Directions*

Porre l'aglio sbucciato in un recipiente assieme a qualche grano di sale grosso. Frullare finché l'aglio si sarà ridotto in crema, aggiungere le foglie di basilico insieme ad un pizzico di sale grosso, aggiungere i pinoli e continuare a frullare per ridurre in crema. Aggiungere i formaggi un po' alla volta per rendere ancora più cremosa la salsa, mescolando continuamente. Aggiungere l'olio di oliva extravergine mescolando sempre con il mixer. Amalgamare bene gli ingredienti fino ad ottenere una salsa omogenea.

Process basil, oil, parmesan, pine nuts, pecorino, and garlic in a food processor until smooth; season with salt.



INGREDIENTI / *INGREDIENTS*

½ spicchio d'aglio a persona
Sale marino grosso q.b.
100 ml di olio di oliva extravergine
25 gr di foglie di basilico ligure a persona
1 cucchiaino a persona di pecorino grattugiato
15 g di pinoli a persona
35 g di parmigiano reggiano grattugiato

½ clove of garlics
Coarse sea salt to taste
100 ml spoon of extra virgin olive oil
25 g of basil leaves
1 spoon of grated pecorino
15 g pine nut
35 g grated parmesan



Mixer 450 W

400



MIXER A IMMERSIONE SERIE HEAVY velocità fissa

STICK BLENDERS HEAVY DUTY LINE fixed speed



La tecnologia SRS consente di ottenere composti estremamente omogenei.
SRS device grants high-quality homogeneous mixtures.



MIXER 350 VF



MIXER 450 VF



MIXER 650 VF



30/80 Lt.



FM 300



80/120 Lt.



FM 400



150/230 Lt.



FM 500



250/330 Lt.



FM 600

- Apparecchi per uso professionale
- Ideali per pasticcerie, gelaterie, ristoranti, alberghi
- Corpo realizzato in plastica con disegno esclusivo
- Apparecchio per grandi lavorazioni
- Motore ventilato di produzione nazionale
- Termica di protezione al motore
- Impugnatura ergonomica per un maggiore comfort d'utilizzo
- Display a cristalli liquidi
- Sistema elettronico di stabilizzazione di velocità e potenza SRS
- Giunti di connessione in polimero ad alta resistenza
- Mescolatore in acciaio inox disponibili 300-400-500 e 600 mm
- Innesto mescolatore a vite
- Lame forgiate in acciaio
- Campana in acciaio inox
- Norme CE
- Apparecchio certificato da ente di controllo
- Fabbricato in Italia

- Professional equipment
- Particularly suited for ice cream shops, confectioner's, restaurants, hotels
- Exclusive body design made from plastic
- Heavy duty hand mixer available in 3 motor sizes to meet the demands of any kitchens 350W, 450W and 650W
- Italian make ventilated motor
- Thermal overload protection included
- Ergonomic handle for comfortable use
- Liquid crystal digital display
- Control board equipped with SRS device for power and speed stabilization
- High grade joints made from polymer
- Fully detachable stainless steel shafts available in 4 lengths: 300-400-500 and 600 mm
- Bayonet attachments clutch, and double sealed shafts for hygienic use
- Full stainless steel, high performance blade
- All food contact parts in stainless steel
- CE approved
- Patented machine
- Proudly Made in Italy



Lame in acciaio INOX
facili da smontare
Steel blades easy
to disassemble



FSPS Supporto
parete singolo
Single wall support



Display luminoso con tasto di avvio
Luminous display with start button

FSP Supporto pentola regolabile e con snodo libero
Adjustable pot support with free articulated joint

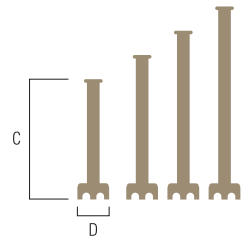
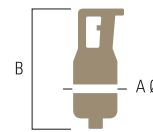

	Codice Model code	A	B	C	D	B+C	Peso netto Net weight		Alimentazione Power supply	Potenza Motor power	Velocità Speed	Dimensioni imballo Packing dimensions
		mm	mm	mm	mm	mm	kg	lt.	Volt/Hz	Watt	Giri/Rpm	mm
MIXER 350 VF												
Corpo+Mescolatore 300 mm./Body+Blender Tube 300 mm.	FM350VF300	130	360	330	95	680	3,8	30	230 V - 50/60	350	15.000	350x470x140
Corpo+Mescolatore 400 mm./Body+Blender Tube 400 mm.	FM350VF400			430		780	4,05	80				350x470x140
Corpo+Mescolatore 500 mm./Body+Blender Tube 500 mm.	FM350VF500			530		880	4,25	150				800x300x140
Corpo+Mescolatore 600 mm./Body+Blender Tube 600 mm.	FM350VF600			630		980	4,5	250				800x300x140
MIXER 450 VF												
Corpo+Mescolatore 300 mm./Body+Blender Tube 300 mm.	FM450VF300	130	380	330	95	700	4,4	50	230 V - 50/60	450	17.000	350x470x140
Corpo+Mescolatore 400 mm./Body+Blender Tube 400 mm.	FM450VF400			430		800	4,65	100				350x470x140
Corpo+Mescolatore 500 mm./Body+Blender Tube 500 mm.	FM450VF500			530		900	4,85	200				800x300x140
Corpo+Mescolatore 600 mm./Body+Blender Tube 600 mm.	FM450VF600			630		1000	5,1	300				800x300x140
MIXER 650 VF												
Corpo+Mescolatore 300 mm./Body+Blender Tube 300 mm.	FM650VF300	130	400	330	95	720	4,8	80	230 V - 50/60	650	13.000	350x470x140
Corpo+Mescolatore 400 mm./Body+Blender Tube 400 mm.	FM650VF400			430		820	5,05	120				350x470x140
Corpo+Mescolatore 500 mm./Body+Blender Tube 500 mm.	FM650VF500			530		920	5,25	230				800x300x140
Corpo+Mescolatore 600 mm./Body+Blender Tube 600 mm.	FM650VF600			630		1020	5,5	330				800x300x140
COMPONENTI / Components												
Corpo Motore 350VF/Body Motor Mixer 350VF	FM350VF	130	360				2,6		230 V - 50/60	350	15.000	
Corpo Motore 450VF/Body Motor Mixer 450VF	FM450VF		380				3,2			450	17.000	440x190x160
Corpo Motore 650VF/Body Motor Mixer 650VF	FM650VF		400				3,6			650	13.000	
Mescolatore 300 mm./Blender Tube 300 mm.	FM300			330	95		1,20	30/80				650x100x100
Mescolatore 400 mm./Blender Tube 400 mm.	FM400			430		1,45	80/120					
Mescolatore 500 mm./Blender Tube 500 mm.	FM500			530		1,65	150/230					
Mescolatore 600 mm./Blender Tube 600 mm.	FM600			630		1,90	250/330					



MIXER A IMMERSIONE SERIE HEAVY velocità variabile

STICK BLENDERS HEAVY DUTY LINE variable speed



La tecnologia SRS consente di ottenere composti estremamente omogenei. SRS device grants high-quality homogeneous mixtures.



MIXER 350 VV



MIXER 450 VV



MIXER 650 VV



FAF



30/80 Lt.



FM 300



80/120 Lt.



FM 400



150/230 Lt.



FM 500



250/330 Lt.



FM 600

- Apparecchi per uso professionale
- Ideali per pasticcerie, gelaterie, ristoranti, alberghi
- Corpo realizzato in plastica con disegno esclusivo
- Apparecchio per grandi lavorazioni
- Motore ventilato di produzione nazionale
- Termica di protezione al motore
- Variatore di velocità con interruttore digitale
- Impugnatura ergonomica per un maggiore comfort d'utilizzo
- Display a cristalli liquidi
- Sistema elettronico di stabilizzazione di velocità e potenza SRS
- Giunti di connessione in polimero ad alta resistenza
- Mescolatore e frusta in acciaio inox
- Mescolatore in acciaio inox disponibili 300-400-500 e 600 mm
- Innesto mescolatore e frusta a vite
- Lame forgiate in acciaio
- Campana in acciaio inox
- Norme CE
- Apparecchio certificato da ente di controllo
- Fabbriato in Italia

- Professional equipment
- Particularly suited for ice cream shops, confectioner's, restaurants, hotels
- Exclusive body design made from plastic
- Heavy duty hand mixer available in 3 motor sizes to meet the demands of any kitchens 350W, 450W and 650W
- Italian make ventilated motor
- Thermal overload protection included
- Variable speed digital switch
- Ergonomic handle for comfortable use
- Liquid crystal digital display
- Control board equipped with SRS device for power and speed stabilization
- High grade joints made from polymer
- Fully detachable stainless steel shafts available in 4 lengths: 300-400-500 and 600 mm 360 mm whisk attachment also available
- Bayonet attachments clutch, and double sealed shafts for hygienic use
- Full stainless steel, high performance blade
- All food contact parts in stainless steel
- CE approved
- Patented machine
- Proudly Made in Italy

INOX

Lame in acciaio INOX
facili da smontare
S/steel blades easy
to disassemble



FSPC Support parete
Wall support



Regolatore a 9 velocità
con display luminoso
Luminous display
with 9 speeds regulator

FSP Supporto pentola regolabile e con snodo libero
Adjustable pot support with free articulated joint

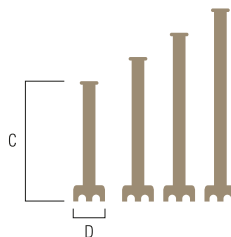
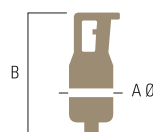

	Codice Model code	A	B	C	D	B+C	E	F	B+E	Peso netto Net weight	Peso Weight	Alimentazione Power supply	Potenza Motor power	Velocità Speed	Dimensioni imballaggio Packaging dimensions
		mm	mm	mm	mm	mm	mm	mm	mm	kg	lt.	Volt/Hz	Watt	Giri/Rpm	mm
MIXER 350 VV															
Corpo+Frusta+Mescolatore 300 mm./Body+Whip+Blender Tube 300 mm.	FM350VVC300	130	360	330	95	680	360	120	710	4,7	30	230 V - 50/60	350	● 2.000 9.000 MAX 15.000	350x470x140
Corpo+Frusta+Mescolatore 400 mm./Body+Whip+Blender Tube 400 mm.	FM350VVC400			430		780				4,95	80				350x470x140
Corpo+Frusta+Mescolatore 500 mm./Body+Whip+Blender Tube 500 mm.	FM350VVC500			530		880				5,15	150				800x300x140
Corpo+Frusta+Mescolatore 600 mm./Body+Whip+Blender Tube 600 mm.	FM350VVC600			630		980				5,4	250				800x300x140
MIXER 450 VV															
Corpo+Frusta+Mescolatore 300 mm./Body+Whip+Blender Tube 300 mm.	FM450VVC300	130	380	330	95	700	360	120	730	5,3	50	230 V - 50/60	450	■ 2.000 11.000 MAX 17.000	350x470x140
Corpo+Frusta+Mescolatore 400 mm./Body+Whip+Blender Tube 400 mm.	FM450VVC400			430		800				5,55	100				350x470x140
Corpo+Frusta+Mescolatore 500 mm./Body+Whip+Blender Tube 500 mm.	FM450VVC500			530		900				5,75	200				800x300x140
Corpo+Frusta+Mescolatore 600 mm./Body+Whip+Blender Tube 600 mm.	FM450VVC600			630		1000				6,10	300				800x300x140
MIXER 650 VV															
Corpo+Frusta+Mescolatore 300 mm./Body+Whip+Blender Tube 300 mm.	FM650VVC300	130	400	330	95	720	360	120	750	5,7	80	230 V - 50/60	650	▲ 2.000 9.000 MAX 13.000	350x470x140
Corpo+Frusta+Mescolatore 400 mm./Body+Whip+Blender Tube 400 mm.	FM650VVC400			430		820				5,95	120				350x470x140
Corpo+Frusta+Mescolatore 500 mm./Body+Whip+Blender Tube 500 mm.	FM650VVC500			530		920				6,15	230				800x300x140
Corpo+Frusta+Mescolatore 600 mm./Body+Whip+Blender Tube 600 mm.	FM650VVC600			630		1020				6,40	330				800x300x140
COMPONENTI / Components															
Corpo Motore 350VV/Body Motor Mixer 350VV	FM350VV	130	360							2,6		230 V - 50/60	350	●	
Corpo Motore 450VV/Body Motor Mixer 450VV	FM450VV		380							3,2			450	■	440x190x160
Corpo Motore 650VV/Body Motor Mixer 650VV	FM650VV		400							3,6			650	▲	
Mescolatore 300 mm./Blender Tube 300 mm.	FM300			330	95					1,20	30/80				650x100x100
Mescolatore 400 mm./Blender Tube 400 mm.	FM400			430						1,45	80/120				
Mescolatore 500 mm./Blender Tube 500 mm.	FM500			530						1,65	150/230				
Mescolatore 600 mm./Blender Tube 600 mm.	FM600			630						1,90	250/330				
Frusta /Whip	FAF						360	120		0,90	80				390x120x90



Tiramisù / *Tiramisù*

Veneto



Preparazione / *Directions*

Prendere le uova e dividere gli albumi dai tuorli, aggiungere ai tuorli metà dello zucchero e montare con la frusta elettrica fino ad ottenere un bel composto spumoso, cremoso e chiaro. Aggiungere il mascarpone al composto di tuorli; in seguito montate gli albumi sempre con la frusta. Quando saranno semimontati aggiungere l'altra metà dello zucchero e continuare a montare a neve. Aggiungere gli albumi ai tuorli, mascarpone e zucchero. Disporre i savoiardi sul fondo delle coppette o in un'unica teglia, versarvi il caffè facendo attenzione a non inzupparli troppo. Disporre la crema sopra i savoiardi. Spolverare con il cacao in polvere. Cospargere la superficie con le scaglie di cioccolato. Riporre in frigo per qualche ora per far compattare.

In a medium saucepan, whisk together egg yolks and sugar until well blended. Add mascarpone into yolk mixture and whisk until the cream and mascarpone have completely combined. Meanwhile, beat egg whites until they have the consistency of thickly whipped cream and mix them to the mascarpone and yolk mixture. Get your serving dish ready. Put the coffee into a shallow dish and dip in a few sponge fingers at a time, turning for a few secs until they are nicely soaked, but not soggy. Layer these into your dish until you have used half the biscuits, then spread over half of the creamy mixture. Using the coarse side of the grater, grate over most of the chocolate. Then repeat the layers (you should use up all the coffee), finishing with the creamy layer. Cover and chill for a few hrs or overnight. To serve, dust with cocoa powder and grate over the remainder of the chocolate.

INGREDIENTI / *INGREDIENTS*

6 uova medie
120 g di zucchero + 2 cucchiari per il caffè
500 g di mascarpone
Caffè q.b. per bagnare i savoiardi
Cacao in polvere q.b. per spolverizzare il tiramisù
Cioccolato in scaglie q.b. per ricoprire il tiramisù
400 g di biscotti Savoiaardi

6 eggs
120 g sugar + 2 spoon for coffee
500 g mascarpone cheese
Coffee to taste, to soak ladyfinger
Dry cocoa to taste
Chocolate chips
400 g ladyfinger







MIXER A IMMERSIONE SERIE LIGHT velocità fissa

STICK BLENDERS LIGHT DUTY LINE fixed speed

MIXER 250 VF



La tecnologia SRS consente di ottenere composti estremamente omogenei. SRS device grants high-quality homogeneous mixtures.

Mescolatore *Blending Tube* 250 mm

MIXER 250 VF



20 Lt.



FM 250



15 Lt.



FM 200

- Apparecchi per uso professionale
- Ideali per pasticcerie, gelaterie, ristoranti, alberghi
- Corpo realizzato in plastica con disegno innovativo
- Apparecchi dal peso contenuto e di facile utilizzo
- Motore ventilato di produzione nazionale
- Termica di protezione al motore
- Sistema elettronico di stabilizzazione di velocità e potenza SRS
- Giunti di connessione in polimero ad alta resistenza
- Mescolatore in acciaio inox
- Innesto a baionetta
- Lame forgiate in acciaio
- Campana in acciaio inox
- Norme CE
- Apparecchio certificato da ente di controllo
- Fabbricato in Italia

- Professional equipment
- Particularly suited for ice cream shops, confectioner's, restaurants, hotels
- Exclusive body design made from plastic
- User friendly and light tool for comfortable use
- Italian make ventilated motor
- Thermal overload protection included
- Control board equipped with SRS device for power and speed stabilization
- High grade joints made from polymer
- Fully detachable stainless steel shafts available in 2 lengths: 200-250 mm
- Full stainless steel, high performance blade and all food contact parts in stainless steel
- CE APPROVED
- Patented stick blender
- Proudly Made in Italy

INOX



Lame in acciaio INOX facili da smontare
S/steel blades easy to disassemble



FSPM
Supporto parete mini per mixer 250
Wall support for mixer 250



Estrema facilità di smontaggio utensile
Impugnatura ergonomica

Easy accessory changing clutch
Ergonomic handle



Semplicità d'uso
User friendly

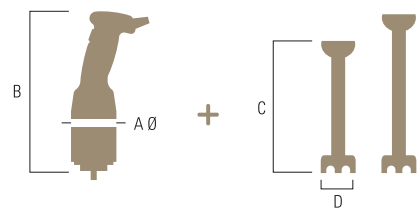

MIXERS

MIXER 250 VF

	Confice Model code	A	B	C	D	B+C	E	F	Peso netto Net weight	Peso lordo Gross weight	Alimentazione Power supply	Potenza Motor power	Velocità Speed	Dimensioni imballo Packing dimensions
		mm	mm	mm	mm	mm	mm	mm	kg	lt.	Volt/Hz	Watt	Giri/Rpm	mm
Corpo+Mescolatore 200 mm./Body+Blender Tube 200 mm.	FM250VF200	75	285	220	75	470			1,4	15	250Watt 230V-50/60 HZ	250	15.000	250x360x80
Corpo+Mescolatore 250 mm./Body+Blender Tube 250 mm.	FM250VF250			270		520			1,45	20				250x360x80

COMPONENTI / Components

Corpo Motore 250VF/Body Motor Mixer 250VF	FM250VF	75	285						1		250Watt 230V-50/60 HZ	250	15.000	
Mescolatore 200 mm./Blender Tube 200 mm.	FM200			220	75				0,40	15				390x120x115
Mescolatore 250 mm./Blender Tube 250 mm.	FM250			270					0,45	20				



MIXER A IMMERSIONE SERIE LIGHT velocità variabile

STICK BLENDERS LIGHT DUTY LINE variable speed



La tecnologia SRS consente di ottenere composti estremamente omogenei. SRS device grants high-quality homogeneous mixtures.



Mescolatore Blending Tube 200 mm

MIXER 250 VV



Mescolatore Blending Tube 250 mm

MIXER 250 VV



Frusta Whip

MIXER 250 VV

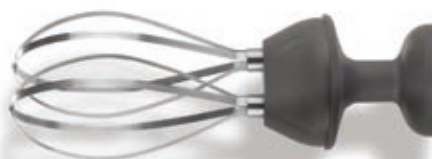

FAFLM



20 Lt.



FM 250



Tubo Emulsionatore Emulsifying Tube FE 250*



15 Lt.



FM 200



Tubo Emulsionatore Emulsifying Tube FE 200*

- Apparecchi per uso professionale
- Ideali per pasticcerie, gelaterie, ristoranti, alberghi
- Corpo realizzato in plastica con disegno innovativo
- Apparecchi dal peso contenuto e di facile utilizzo
- Motore ventilato di produzione nazionale
- Termica di protezione al motore
- Variatore di velocità
- Sistema elettronico di stabilizzazione di velocità e potenza SRS
- Giunti di connessione in polimero ad alta resistenza
- Mescolatore e fruste in acciaio inox
- Mescolatori ed emulsionatori disponibile in due misure: 200 e 250 mm
- Innesto a baionetta
- Lame e disco emulsionatore in acciaio INOX
- Campana in acciaio inox
- Norme CE
- Apparecchio certificato da ente di controllo
- Fabbriato in Italia

- Professional equipment
- Particularly suited for ice cream shops, confectioner's, restaurants, hotels
- Exclusive body design made from plastic
- User friendly and light tool for comfortable use
- Italian make ventilated motor
- Thermal overload protection included
- Variable speed
- Control board equipped with SRS device for power and speed stabilization
- High grade joints made from polymer
- Fully detachable stainless steel shafts
- Blender and emulsifying tubes available in 2 lengths: 200-250 mm
- Full stainless steel, high performance blade
- All food contact parts in stainless steel
- CE APPROVED
- Patented stick blender
- Proudly Made in Italy



INOX

Disco emulsionatore
Emulsifying disc

Lame in acciaio
INOX facilmente
intercambiabili
S/steel easy
interchangeable
blades



FSPCM Supporto parete mini
per mixer 250
Wall support for mixer 250



FSPM Supporto parete mini
per combi 250
Wall support mini for combi 250



Nuova frusta
New whip

Estrema facilità
di smontaggio utensile
Impugnatura ergonomica
Variatore di velocità

Easy accessory
changing clutch
Ergonomic handle
Speed variator

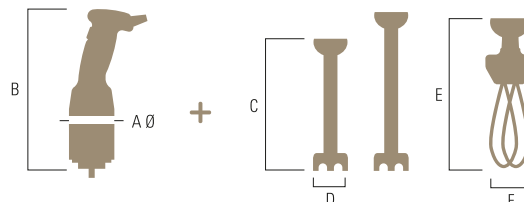

	Codice Model code	A	B	C	D	B+C	E	F	B+E	Peso netto Net weight		Alimentazione Power supply	Potenza Motor power	Velocità Speed	Dimensioni imballo Packing dimensions
		mm	mm	mm	mm	mm	mm	mm	mm	kg	lt.	Volt/Hz	Watt	Giri/Rpm	mm
MIXER 250 VV															
Corpo+Frusta+Mescolatore 200 mm./Body+Whip+Blender Tube 200 mm.	FM250VVC200	75	285	220	75	470	290	90	590	1,4	15	250Watt 230V-50/60 HZ	250	● 2.500 15.000	380x340x90
Corpo+Frusta+Mescolatore 250 mm./Body+Whip+Blender Tube 250 mm.	FM250VVC250			270		520				1,45	20				250x360x80

COMPONENTI / Components

Corpo Motore 250V/Body Motor Mixer 250V	FM250V	75	285							1		250Watt 230V-50/60 HZ	250	●	390x120x115
Mescolatore 200 mm./Blender Tube 200 mm.	FM200			220	75					0,40	15				
Mescolatore 250 mm./Blender Tube 250 mm.	FM250			270						0,45	20				
Tubo Emulsionatore 200mm./Emulsifying Tube 200mm.	FE 200			220						0,40	15				
Tubo Emulsionatore 250mm./Emulsifying Tube 250mm.	FE250			270						0,45	20				
Frusta/Whip	FAFLM						290	90		0,45					

MIXERS



MIXER A IMMERSIONE SERIE LIGHT velocità variabile

STICK BLENDERS LIGHT DUTY LINE variable speed



La tecnologia SRS consente di ottenere composti estremamente omogenei. SRS device grants high-quality homogeneous mixtures.



MIXER 300 VV



MIXER 400 VV



FAFL



30/50 Lt.



FM 300L



50/80 Lt.



FM 400L



80/100 Lt.



FM 500L

- Apparecchi per uso professionale
- Ideali per pasticcerie, gelaterie, ristoranti, alberghi
- Corpo realizzato in plastica con disegno innovativo
- Apparecchi dal peso contenuto e di facile utilizzo
- Motore ventilato di produzione nazionale
- Termica di protezione al motore
- Variatore di velocità
- Sistema elettronico di stabilizzazione di velocità e potenza SRS
- Giunti di connessione in polimero ad alta resistenza
- Mescolatore e frusta in acciaio inox
- Mescolatore disponibile in 3 misure 300-400-500 mm
- Innesto a baionetta
- Lame forgiate in acciaio
- Campana in acciaio inox
- Norme CE
- Apparecchio certificato da ente di controllo
- Fabbricato in Italia

- Professional equipment
- Particularly suited for ice cream shops, confectioner's, restaurants, hotels
- Exclusive body design made from plastic
- User friendly and light tool for comfortable use
- Italian make ventilated motor
- Thermal overload protection included / Variable speed
- Control board equipped with SRS device for power and speed stabilization
- High grade joints made from polymer
- Fully detachable stainless steel shafts available in 3 lengths 300-400-500 mm
- Full stainless steel, high performance blade c
- All food contact parts in stainless steel
- CE APPROVED
- Patented stick blender
- Proudly Made in Italy



INOX

Lame in acciaio INOX
facili da smontare
S/steel blades easy
to disassemble

FSPC Supporto parete per Combi
Wall support for Combi



Innesto a sgancio rapido
che semplifica l'inserimento
degli accessori
Quick-and-Easy clutch



FSP Supporto pentola regolabile e con snodo libero
Adjustable pot support with free articulated joint



Pulsante in dimensioni ottimali
Display luminoso con regolatore a 9 velocità
Handy starter
Luminous display with 9 speeds regulator

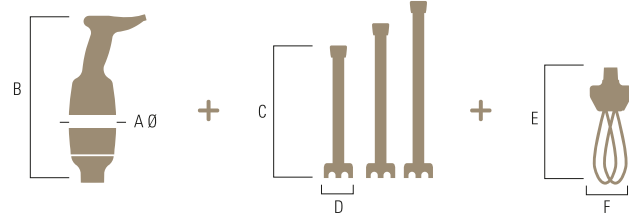

	Codice Model code	A	B	C	D	B+C	E	F	B+E	Peso netto Net weight	lit.	Alimentazione Power supply	Potenza Motor power	Velocità Speed	Dimensioni imballo Packing dimensions
		mm	mm	mm	mm	mm	mm	mm	mm	kg		Volt/Hz	Watt	Giri/Rpm	mm
MIXER 300 VV															
Corpo+Frusta+Mescolatore 300 mm./Body + Whip + Blender Tube 300 mm	FM300VVC300			340		650				3,45	30			●	350x470x140
Corpo+Frusta+Mescolatore 400 mm./Body + Whip + Blender Tube 400 mm	FM300VVC400	100	350	440	85	750	330	120	640	3,60	50	230 V - 50/60	300	2.000 9.000 MAX 13.000	350x470x140
Corpo+Frusta+Mescolatore 500 mm./Body + Whip + Blender Tube 500 mm	FM300VVC500			540		850				3,80	80				800x300x140
MIXER 400 VV															
Corpo+Frusta+Mescolatore 300 mm./Body + Whip + Blender Tube 300 mm	FM400VVC300			340		650				3,75	50			■	350x470x140
Corpo+Frusta+Mescolatore 400 mm./Body + Whip + Blender Tube 400 mm	FM400VVC400	100	350	440	85	750	330	120	640	3,90	80	230 V - 50/60	400	2.000 9.000 MAX 15.000	350x470x140
Corpo+Frusta+Mescolatore 500 mm./Body + Whip + Blender Tube 500 mm	FM400VVC500			540		850				4,10	100				800x300x140
COMPONENTI / Components															
Corpo Motore 300 VV/Body Motor Mixer 300VV	FM300VV	100	350							1,80		230 V - 50/60	300	●	440x190x160
Corpo Motore 400 VV/Body Motor Mixer 400VV	FM400VV									2,10					
Mescolatore 300 mm./Blender Tube 300 mm.	FM300L			340						0,85	30/50				650x100x100
Mescolatore 400 mm./Blender Tube 400 mm.	FM400L			440	85					1,00	50/80				
Mescolatore 500 mm./Blender Tube 500 mm.	FM500L			540						1,20	80/100				
Frusta/Whip	FAFL						330	120		0,80	40				390x120x115



Carpaccio di tonno agli agrumi *Citrus juice tuna carpaccio*

Sicilia



Preparazione / Directions

Affettare del tonno crudo e porlo in una casseruola dai bordi alti, spremere il succo di limone e ricoprire completamente il tonno. Lasciare marinare in frigorifero per almeno 20 minuti.
Spremere un'arancia, mettere il succo in una ciotola e unire due cucchiaini di olio d'oliva extravergine. Unire al succo d'arancia una spolverata di pepe nero, sale e prezzemolo. Mescolare il tutto per ottenere un'emulsione. Prendere le altre arance e sbuciarle eliminando anche la parte bianca, incidere ogni singolo spicchio e tagliare a tocchetti. Togliere dal frigo le fette di tonno ormai marinate. Scolare le fette di tonno dal succo di limone, disporle su un piatto adagiandovi sopra qualche foglia di lattughino, aggiungere i tocchetti di arancia e condire con l'emulsione di succo d'arancia, per profumare il piatto aggiungete qualche grano di pepe rosa.

Cut tuna into very thin slices like beef carpaccio, squeeze a lemon and pour the juice on the tuna slices to cover them all. Place the tuna slices in the fridge and marinate them for 20 mins. Meanwhile, squeeze an orange and mix the juice with oil, salt, parsley and black pepper. Place the tuna slices on a serving dish and garnish with orange bits, lettuce and pink peppercorns.



INGREDIENTI / INGREDIENTS

300 grammi di Tonno fresco	300 g tuna
3 Limoni	3 lemons
3 Arance	3 oranges
Lattughino	Lettuce
2 cucchiaini di olio extravergine di oliva	2 spoon of extra virgin olive oil
Prezzemolo q.b.	Parsley to taste
Sale q.b.	Salt to taste
Pepe nero q.b.	Black pepper to taste
Pepe rosa q.b.	Pink pepper to taste





AFFETTATRICI GRAVITÀ SERIE 220 250 SERIE 220 250 275 ECO

GRAVITY SLICER 220 250 MODELS ECO SLICER 220 250 275 MODELS



250

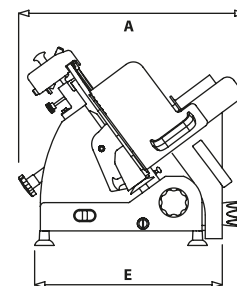
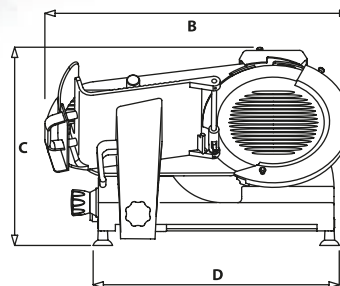

220



250

220 250

- Apparecchio per uso professionale
- Per bar, ristoranti, piccole comunità
- Macchina realizzata in lega di alluminio anodizzato
- Motore asincrono ventilato
- Lama di produzione nazionale
- Anello di protezione
- Boccole carrello autolubrificanti
- Versione CE con blocco al carrello
- Supporto vela maggiorato
- Ampio piatto porta salumi
- Protezione in plastica al carrello
- Curata nei dettagli
- Trasmissione a cinghia
- Affilatoio incorporato
- Corsa carrello maggiorata (mod. 250)
- Norme CE
- Fabbricata in Italia Italia

- Professional equipment
- Ideally suited for the small hotel, pub, snack bar, café, club etc
- Slicer made from highly polished anodised food-grade aluminium
- Ventilated asynchronous motor
- Italian make blades
- Safety ring
- Permanently lubricated carriage ball bearings
- CE MODELS with carriage locking option
- Capacious food plate
- Safety carriage plastic cover
- High quality gravity feed slicer
- Belt transmission
- Sharpening accessory included
- CE approved
- Proudly Made in Italy

220 250 275 ECO

- Apparecchio per uso domestico
- Per piccole comunità e famiglie
- Macchina in alluminio pressofuso verniciato
- Lama tornita
- Anello di protezione
- Boccole carrello autolubrificanti
- Piatto porta salumi scorrevole
- Protezione in plexiglass al carrello
- Curata nei dettagli
- Trasmissione a cinghia
- Motore asincrono ventilato
- Affilatoio incorporato
- Norme CE domestico
- Fabbricata in Italia

- Home use equipment
- Ideally suited for families
- Medium duty slicer made from highly polished anodised food-grade aluminium
- Turned blade
- Safety ring
- Permanently lubricated carriage ball bearings
- Sliding feeding pan
- Safety carriage plexiglass cover
- High quality gravity feed slicer
- Belt transmission
- Ventilated asynchronous motor
- Sharpening accessory included
- CE approved domestic
- Proudly Made in Italy

	Ø Lama Ø Blade size	A	B	C	D	E	Corsa carrello Carriage sliding	Capo taglio Cutting capacity	Spessore taglio Slice thickness	Alimentazione Power supply	Potenza Motor power	Peso netto Net weight	Dimensioni imballaggio Packing dimensions
	mm	mm	mm	mm	mm	mm	mm	mm	mm	Volt/Hz	Kwatt/Hp	kg	mm
220	220	400	450	370	420	330	240	170x210	14,0	230/50	0,25 (0,35)	13,0	560x470x460
250	250	440	570	370	470	310	260	190x250	14,0	230/50	0,25 (0,35)	19,0	560x470x460
220 ECO	220	385	480	340	415	265	255	230x160	15,0	230/50	0,14 (0,19)	12,0	540x470x390
250 ECO	250	385	480	365	415	265	255	230x185	15,0	230/50	0,14 (0,19)	14,0	560x470x390
275 ECO	275	410	505	375	415	265	255	230x190	15,0	230/50	0,15 (0,20)	16,0	530x490x430



220 ECO



250 ECO



275 ECO



AFFETTATRICI GRAVITÀ SERIE 275 300 330 350

GRAVITY SLICER 275 300 330 350 MODELS

300

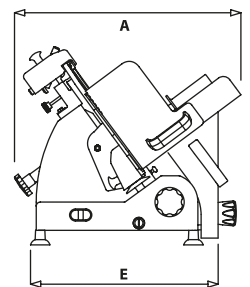
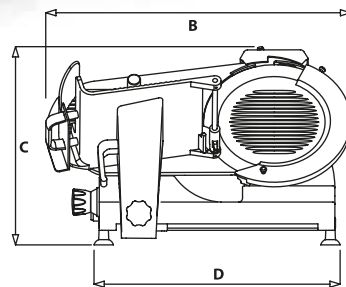

275



300



330

275 300

- Macchine per uso professionale
- Destinate a macellerie, comunità, hotel, alberghi, ristoranti
- Fusione in lega di alluminio anodizzato
- Motore asincrono ventilato
- Lama forgiata di produzione nazionale
- Anello di protezione alla lama
- Boccole carrello autolubrificanti
- Blocco al carrello come da normativa
- Supporto vela maggiorato
- Ampio piatto porta salumi
- Curata nei dettagli
- Priva di spigoli
- Protezione in plastica al carrello
- Trasmissione con robusta cinghia in poliestere
- Scheda elettrica a 24 volt
- Interruttore digitale
- Affilatoio incorporato
- Norme CE
- Fabbricata in Italia

- Professional equipment
- Ideally suited for hotel, pub, snack bar, café, club, restaurants, butcheries, etc
- made from highly polished anodised food-grade aluminium
- Ventilated asynchronous motor
- Italian make forged blade
- Blade safety ring
- Permanently lubricated carriage ball bearings
- CE approved carriage
- Capacious food plate
- High quality gravity feed slicer
- No Sharp corners slicer
- Safety carriage plastic cover
- Powerful polyester belt driven transmission
- 24 volt. Low tension card
- Digital ON/OFF switch
- Sharpening accessory included
- CE approved
- Proudly Made in Italy

330 350

- Macchine affetta salumi professionali
- Destinate a macellerie, supermarket, grandi comunità
- Fusione in lega di alluminio anodizzato
- Motore asincrono ventilato
- Lama tornita di produzione nazionale
- Anello di protezione alla lama
- Boccole carrello autolubrificanti
- Blocco al carrello come da normativa
- Protezione al carrello in plexiglas
- Supporto vela maggiorato
- Vela spessore 15mm. (unica in Italia)
- Ampio piatto porta salumi
- Priva di spigoli
- Curata nei dettagli
- Trasmissione a cinghia in poliestere
- Affilatoio incorporato
- Norme CE
- Fabbricata in Italia

- Professional equipment
- Ideally suited for butcheries, supermarkets, etc
- Heavy duty slicer made from highly polished anodised food-grade aluminium
- Ventilated asynchronous motor
- Italian make turned blade
- Blade safety ring
- Permanently lubricated carriage ball bearings
- CE approved carriage locking
- Safety carriage plexiglass cover
- 15 mm. fence thickness (sole in Italy)
- Capacious feeding pan
- No Sharp corners slicer
- High quality gravity feed slicer
- Powerful polyester belt driven transmission
- Sharpening accessory included
- CE approved
- Proudly Made in Italy

	Ø Lama Ø Blade size	A	B	C	D	E	Corsa carrello Carriage sliding	Cap. taglio Cutting capacity	Spessore taglio Slice thickness	Alimentazione Power supply	Potenza Motor power	Peso netto Net weight	Dimensioni imballo Packing dimensions
	mm	mm	mm	mm	mm	mm	mm	mm	mm	Volt/Hz	Kwatt/Hp	kg	mm
275	275	500	630	420	470	320	270	230x160	15,0	230/50 - 230-400/50	0,27 (0,35)	20	650x570x520
300	300	500	630	420	470	320	270	230x160	15,0	230/50 - 230-400/50	0,27 (0,35)	23	650x570x520
330	330	500	780	480	600	420	330	240x250	15,0	230/50 - 230-400/50	0,38 (0,50)	38,0	790x700x610
350	350	500	800	480	600	420	330	240x250	15,0	230/50 - 230-400/50	0,38 (0,50)	40,0	790x700x610



350



AFFETTATRICI VERTICALI SERIE 300 330 350 370

VERTICAL SLICER 300 330 350 370 MODELS



350

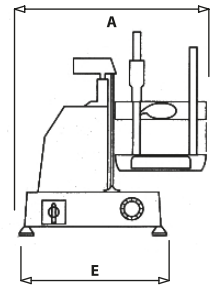
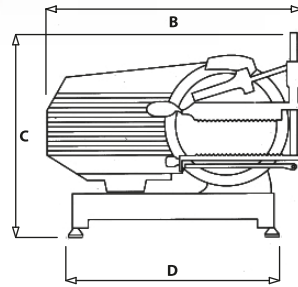

300



330



350

- Macchine professionali
- Ideali per macellerie, supermarket, grandi comunità
- Fusione in lega di alluminio anodizzato
- Lama temprata
- Boccole carrello autolubrificanti
- Blocco al carrello
- Anello di protezione alla lama
- Supporto vela maggiorato
- Scorrevole piatto porta salumi con braccio a cigno
- Curata nei dettagli
- Trasmissione a cinghia in poliestere
- Motore asincrono ventilato
- Affilatoio incorporato
- Chiusura al basamento
- Interruttore digitale
- Scheda a 24 volt
- Norme CE
- Fabbricata in Italia

- Professional equipment
 - Ideally suited for butcheries, supermarkets, etc
 - Heavy duty slicer made from highly polished anodised food-grade aluminium
 - Tempered blade
 - Permanently lubricated carriage ball bearings
 - CE approved carriage locking
 - Blade safety ring
 - High quality vertical feed slicer
 - Polyester Belt transmission
 - Ventilated asynchronous motor
 - Sharpening accessory included
 - Digital ON/OFF switch
 - 24 Low tension card included
 - CE approved
- Proudly Made in Italy

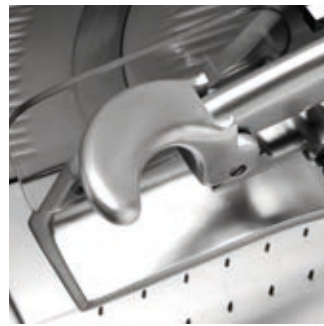

	Ø Lama Ø Blade size	A	B	C	D	E	Corsa carrello Carriage sliding	Cap. taglio Cutting capacity	Spessore taglio Slice thickness	Alimentazione Power supply	Potenza Motor power	Peso netto Net weight	Dimensioni imballo Packing dimensions
	mm	mm	mm	mm	mm	mm	mm	mm	mm	Volt/Hz	Kwatt/Hp	kg	mm
300	300	520	600	480	470	350	300	270x190	15,0	230/50 - 230-400/50	0,30 (0,40)	24,0	720x570x520
330	330	600	700	530	580	420	340	310x230	16,0	230/50 - 230-400/50	0,40 (0,50)	40,0	790x700x610
350	350	600	720	540	580	420	390	310x230	16,0	230/50 - 230-400/50	0,40 (0,50)	45,0	790x700x610
370	370	620	760	570	620	430	420	310x250	16,0	230/50 - 230-400/50	0,40 (0,50)	47,0	790x700x610



370



AFFETTACARNE SERIE 300 350 370

MEAT SLICER 300 350 370 MODELS



350



300



350



370

- Macchine professionali
- Destinate a macellerie e supermarket
- Robusta fusione di lega di alluminio alimentare anodizzato
- Lama forgiata e temprata
- Grande capacità di taglio
- Boccole carrello autolubrificanti
- Versione CE con blocco al carrello
- Supporto vela maggiorato
- Ampio piatto porta salumi
- Braccio stringi salumi a cigno
- Curata nei dettagli
- Trasmissione a cinghia
- Motore asincrono ventilato
- Interruttore digitale
- Scheda a 24 volt
- Affilatoio incorporato
- Norme CE
- Fabbriato in Italia

- Professional equipment
- Ideally suited for butcheries, supermarkets, etc
- Heavy duty slicer made from highly polished anodised food-grade aluminium
- Forged and hardened blade
- Wide cutting capacity
- Permanently lubricated carriage ball bearings
- CE MODELS with carriage locking option
- Swan shaped clamp lever
- High quality vertical feed slicer
- Belt transmission
- Ventilated asynchronous motor
- Digital ON/OFF switch
- 24 Low tension card included
- Sharpener included
- CE approved
- Proudly Made in Italy

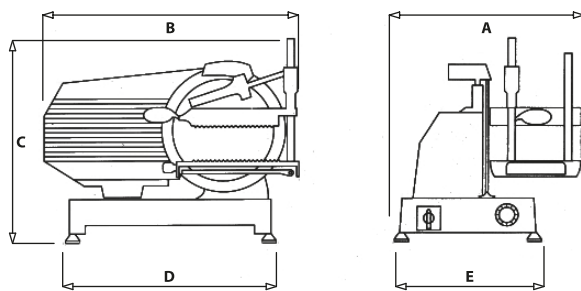

	Ø Lama Ø Blade size	A	B	C	D	E	Corsa carrello Carriage sliding	Cap. taglio Cutting capacity	Spessore taglio Slice thickness	Alimentazione Power supply	Potenza Motor power	Peso netto Net weight	Dimensioni imballo Packing dimensions
	mm	mm	mm	mm	mm	mm	mm	mm	mm	Volt/Hz	Kwatt/Hp	kg	mm
300	300	520	500	480	500	330	300	270x190	16,0	230/50 - 230-400/50	0,35 (0,40)	32,0	650x570x520
350	350	670	570	530	570	420	340	300x245	16,0	230/50 - 230-400/50	0,40 (0,50)	43,0	790x700x610
370	370	680	620	570	620	430	400	340x250	16,0	230/50 - 230-400/50	0,40 (0,50)	46,0	790x700x610



Cozze alla tarantina / *Tarantina mussels*

Puglia



Preparazione / Directions

Lavare e pulire bene le cozze. Aggiungete in un tegame l'olio extra vergine d'oliva, l'aglio intero, il prezzemolo e le cozze, sfumare con mezzo bicchiere di vino bianco finché le cozze non si saranno aperte. Filtrare il liquido di cottura e tenetelo da parte. Fare dorare in una pentola capiente l'aglio tritato nell'olio e aggiungere anche il peperoncino tritato, unite poi la polpa di pomodoro, salare poco poiché il sugo delle cozze risulta già saporito. Cuocere il tutto per cinque minuti. Aggiungere le cozze insieme al loro sugo precedentemente filtrato restringere per almeno cinque minuti. Cospargete con una buona manciata di prezzemolo tritato e pepare. Servire le cozze alla tarantina calde accompagnandole con fette di pane pugliese tostate.

Firstly, clean mussels. Then, Heat the olive oil in a large, heavy Dutch oven over the grill grates. Add the red pepper flakes and garlic and stir until fragrant. Season with salt and pepper, then stir in the tomatoes. Cook, stirring, until some of the tomatoes begin to burst. Stir in the wine. Once it begins to simmer, add the mussels and cover with a lid. Cook just until the mussels open, 6 to 8 minutes. Divide the mussels and cooking liquid among soup bowls. Sprinkle with the parsley and drizzle with olive oil. Serve with the grilled Apulian bread. Grill the bread over medium-high heat until golden and brown on both sides. Serve with olive oil.



INGREDIENTI / INGREDIENTS

1 kg cozze
400 g di polpa di pomodoro
3 spicchi d'aglio
Peperoncino piccante tritato q.b.
½ bicchiere di vino bianco secco
4 cucchiaini olio extravergine d'oliva
Pepe nero macinato q.b.
Sale q.b.
3 ciuffi di prezzemolo

1 kg mussels
400 g tomato pulp
3 clove of garlics
hot chopped pepper to taste
½ glasses of white wine
4 spoon of extra virgin olive oil
Black chopped pepper
Salt to taste
3 cut of parsley

Per accompagnare

4 fette di pane pugliese

To combine

4 slice of Pugliese bread





PELATATE

POTATO PEELER



10 KG ALTO



10 KG



5 KG DA BANCO

5 KG

5 KG ALTO

10 KG

10 KG ALTO

18 KG

18 KG ALTO

- Apparecchio per uso professionale
- Ideale per alberghi e ristoranti
- Struttura completamente in acciaio inossidabile AISI 304
- Motore asincrono ventilato di produzione nazionale
- Pareti abrasive facilmente sostituibili senza l'utilizzo di attrezzi
- Elettrovalvola elettronica per ingresso acqua
- Micro al coperchio e sportello
- Coperchio in plastica trasparente infrangibile
- Cassetto filtro allo scarico di serie
- Visibili e pratici comandi digitali
- Apparato elettrico esterno protetto da ergonomica scatola di plastica isolata
- Timer digitale multifunzione
- Pulsante manuale per scarico prodotto
- Scheda elettronica protetta con scatola in plastica IP 55
- Collettore di scarico a terra o parete
- Trasmissione a cinghia
- Norme CE
- Fabbricato in Italia

- Professional equipment
- Ideally suited for restaurants and hotels
- Entirely structured in AISI 304 s/steel
- Ventilated asynchronous Italian make motor
- Abrasives designed to enable the user to operate, clean and maintain with the minimum of effort
- Water jets electronic valve
- Safety micro switch assembled on the cover and chute
- Unbreakable transparent plastic cover
- Waste filter drawer included
- Digital and user-friendly control panel
- Electric parts covered by safety ergonomic plastic case
- Multifunction digital timer
- Manual discharge button
- IP 55 plastic box control board protection
- Wall or floor discharge outlet
- Belt transmission
- CE approved
- Proudly Made in Italy

Tela abrasiva
Abrasive wall



Piatto pelapatate
Potato peeler plate



OPTIONAL
Coperchio in acciaio INOX
Stainless Steel lid



Parete abrasiva facilmente smontabile per una corretta pulizia senza l'utilizzo di utensili
Easy accessory changing clutch and disassembly for cleaning

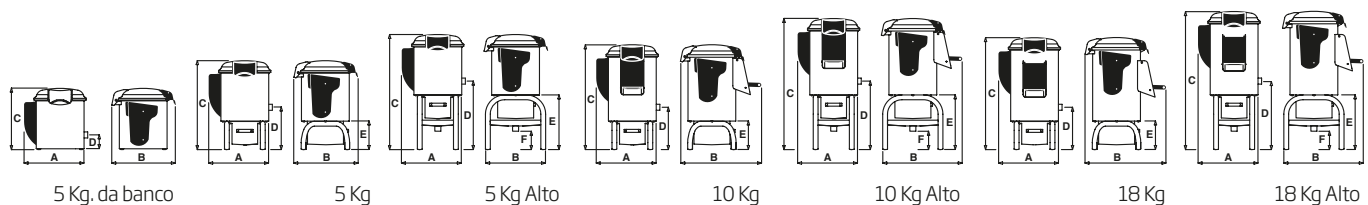

	A	B	C	D	E	F	Alimentazione Power supply	Potenza Motor power	Velocità Speed	Produzione oraria patate Potatoes production per hour	Tempo ciclo pultura Mussel peeling cycle	Carico massimo patate Maximum charge potato	Temperatura acqua Water temperature	Alimentazione tubo flessibile Flexible pipe feeding	Collettore scarico laterale Side discharge manifold	Collettore scarico inferiore Lower discharge manifold	Peso netto Net weight	Dimensioni imballo Packing dimensions	Peso lordo su pallet Gross weight pallet
	mm	mm	mm	mm	mm	mm	Volt/Hz	Kwatt/Hp	rpm	kg/h	sec.	Kg	°C	inch	mm	mm	kg	mm	kg
5 KG DA BANCO	530	520	520	160	---	---	230/50 - 230-400/50	0,37 (0,50)	270	150	60-90	5	5/20	3/4	ø50	-	28,0	670x590x790	31,0
5 KG	530	520	700	350	210	---	230/50 - 230-400/50	0,37 (0,50)	270	150	60-90	5	5/20	3/4	ø50	ø40	35,0	670x590x880	42,0
5 KG ALTO	530	520	950	590	450	140	230/50 - 230-400/50	0,37 (0,50)	270	150	60-90	5	5/20	3/4	ø50	ø50	38,5	670x590x890	45,5
10 KG	530	660	850	350	210	---	230/50 - 230-400/50	0,55 (0,75)	320	300	90-120	10	5/20	3/4	ø50	ø40	40,0	670x590x1020	47,0
10 KG ALTO	530	660	1100	590	450	140	230/50 - 230-400/50	0,55 (0,75)	320	300	90-120	10	5/20	3/4	ø50	ø50	43,0	670x590x1210	50,0
18 KG	530	660	950	350	210	---	230/50 - 230-400/50	0,90 (1,20)	320	500	120-150	18	5/20	3/4	ø50	ø40	43,5	670x590x1120	50,5
18 KG ALTO	530	660	1200	590	450	140	230/50 - 230-400/50	0,90 (1,20)	320	500	120-150	18	5/20	3/4	ø50	ø50	47,0	670x590x1310	54,0



10 KG ALTO



10 KG



5 KG DA BANCO

5 KG

5 KG ALTO

10 KG

10 KG ALTO

18 KG

18 KG ALTO

- Apparecchio per uso professionale
- Ideale per alberghi e ristoranti
- Struttura completamente in acciaio inossidabile AISI 304
- Motore asincrono ventilato di produzione nazionale
- Pareti abrasive facilmente sostituibili senza l'utilizzo di attrezzi
- Elettrovalvola elettronica per ingresso acqua
- Micro al coperchio e sportello
- Coperchio in plastica trasparente infrangibile
- Cassetto filtro allo scarico di serie
- Visibili e pratici comandi digitali
- Apparato elettrico esterno protetto da ergonomica scatola di plastica isolata
- Timer digitale multifunzione
- Pulsante manuale per scarico prodotto
- Scheda elettronica protetta con scatola in plastica IP 55
- Collettore di scarico a terra o parete
- Esclusivo piatto per lavorazione cozze brevettato
- Trasmissione a cinghia
- Norme CE
- Fabbricato in Italia

- Professional equipment
- Ideally suited for restaurants and hotels
- Entirely structured in AISI 304 s/steel
- Ventilated asynchronous Italian make motor
- Abrasives designed to enable the user to operate, clean and maintain with the minimum of effort
- Water jets electronic valve
- Safety micro switch assembled on the cover and chute
- Unbreakable transparent plastic cover
- Waste filter drawer included
- Digital and user-friendly control panel
- Electric parts covered by safety ergonomic plastic case
- Multifunction digital timer
- Manual discharge button
- IP 55 plastic box control board protection
- Wall or floor discharge outlet
- Licensed mussel washer plate
- Belt transmission
- CE approved
- Proudly Made in Italy

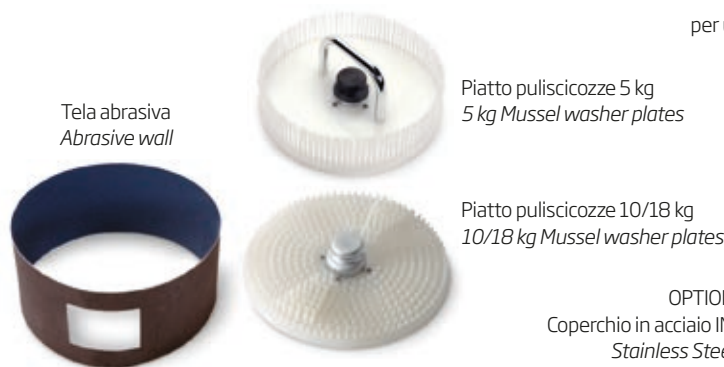

Parete abrasiva facilmente smontabile per una corretta pulizia senza l'utilizzo di utensili
Easy accessory changing clutch and disassembly for cleaning

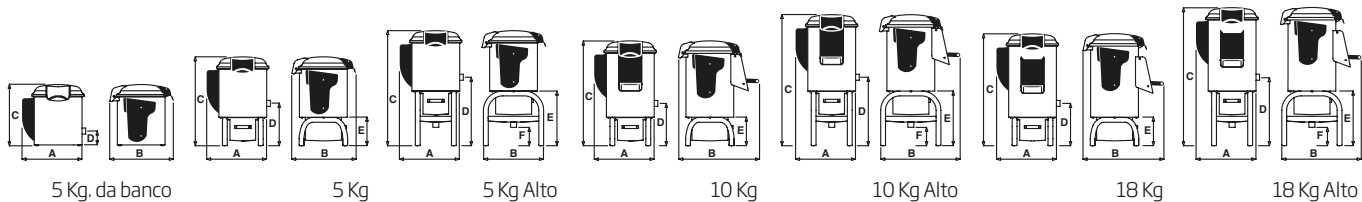

	A	B	C	D	E	F	Alimentazione Power supply	Potenza Motor power	Velocità Speed	Produzione oraria cozze Mussel production per hour	Tempo ciclo pulitura Mussel peeling cycle	Carico massimo cozze Mussel maximum charge	Temperatura acqua Water temperature	Alimentazione tubo flessibile Flexible pipe feeding	Collettore scarico laterale Side discharge manifold	Collettore scarico inferiore Lower discharge manifold	Peso netto Net weight	Dimensioni imballo Packing dimensions	Peso lordo su pallet Gross weight pallet
	mm	mm	mm	mm	mm	mm	Volt/Hz	Kwatt/Hp	rpm	kg/h	sec.	Kg	°C	inch	mm	mm	kg	mm	kg
5 KG DA BANCO	530	520	520	160	----	----	230/50 - 230-400/50	0,35 (0,50)	145	75	90-120	5	5/20	3/4	ø50	-	27,0	670x590x790	30,0
5 KG	530	520	700	350	210	----	230/50 - 230-400/50	0,35 (0,50)	145	75	90-120	5	5/20	3/4	ø50	ø40	34,0	670x590x880	41,0
5 KG ALTO	530	520	950	590	450	140	230/50 - 230-400/50	0,35 (0,50)	145	75	90-120	5	5/20	3/4	ø50	ø50	37,5	670x590x890	44,5
10 KG	530	660	850	350	210	----	230/50 - 230-400/50	0,35 (0,50)	180	150	120-150	10	5/20	3/4	ø50	ø40	38,5	670x590x1020	45,5
10 KG ALTO	530	660	1100	590	450	140	230/50 - 230-400/50	0,35 (0,50)	180	150	120-150	10	5/20	3/4	ø50	ø50	41,5	670x590x1210	48,5
18 KG	530	660	950	350	210	----	230/50 - 230-400/50	0,65 (0,90)	180	250	150-180	18	5/20	3/4	ø50	ø40	42,0	670x590x1120	49,0
18 KG ALTO	530	660	1200	590	450	140	230/50 - 230-400/50	0,65 (0,90)	180	250	150-180	18	5/20	3/4	ø50	ø50	45,5	670x590x1310	52,5



Ratatuja di verdure / *Vegetable ratatouille*

Piemonte



Preparazione / *Directions*

Lavare le verdure per poi affettarle a piccoli pezzi. Riporle in contenitori separati. Soffriggere le cipolle in una padella dai bordi alti con l'olio extravergine d'oliva. Aggiungere a seconda tempi di cottura prima le verdure che impiegano di più a cuocere e in seguito le altre partendo dalle carote e dai fagiolini, poco dopo aggiungere le patate, le zucchine, il sedano e per ultime le melanzane. Aggiungere alla fine i pomodori sbucciati senza semi e cuocere a fuoco basso. Bagnare di tanto in tanto con una tazzina di brodo vegetale. Schiacciare le acciughe con una forchetta in un piattino e tritare aglio, capperi, prezzemolo e salvia. Quando tutte le verdure saranno cotte, aggiungere gli aromi tritati poi le acciughe e l'aceto; alzare la fiamma per fare evaporare l'aceto.

Wash vegetables and chunk them. Place them into separate pans. Set a sauté pan over medium heat and when hot, pour in 2 tbsp olive oil, then add the vegetables carrots and green beans, potatoes, courgettes and celery, and aubergines eventually. Then, tip in tomatoes, and cook them low flamed, pouring veg broth occasionally. In a separate pan, place some anchovy garnished with minced garlic, oil, capers and sage. Once the vegetables are cooked, garnish with the seasonings and some anchovy. Simmer with vinegar and serve.



INGREDIENTI / *INGREDIENTS*

3 patate
2 coste di sedano
2 cipolle
100 g di fagiolini
1 carota
2 zucchine
1 peperone rosso
2 pomodori

1 melanzana
2 acciughe sott'olio
2 spicchi d'aglio
1 ciuffo di prezzemolo
1 rametto di salvia
6 capperi
2 cucchiaini d'aceto di vino bianco
4 cucchiaini olio extravergine d'oliva
Sale q.b.

3 potatoes
2 celery
2 onion
100 g green beans
1 carrot
2 courgettes
1 red pepper
2 tomatoes

1 eggplant
2 anchovies
2 clove of garlics
1 parsley
1 sage
6 capers
2 spoon of White wine vinegar
4 spoon of extra virgin olive oil
Salt to taste





TAGLIAVERDURE ÉLITE

ÉLITE VEGETABLE CUTTER



TAGLIAVERDURE ÉLITE

- Apparecchio per uso professionale molto potente
- Ideale per alberghi e ristoranti
- Carena in acciaio inox 304
- Coperchio in acciaio inox smontabile per pulizia
- Grande scelta di dischi per tagli alimenti
- Tastiera digitale
- Robusto motore asincrono ventilato
- Trasmmissione a cinghie
- Microinterruttore di protezione
- Chiusura al basamento
- Pestello in ABS
- Comandi a 24 volt
- Norme CE
- Fabbricato in Italia

- Professional equipment
- Ideally suited for the small hotel, pub, snack bar, café, club etc
- Slicer made from highly polished anodised food-grade aluminium
- Ventilated asynchronous motor
- Italian made blades
- Safety ring
- Permanently lubricated carriage ball bearings
- CE MODELS with carriage locking option
- Capacious food plate
- Safety carriage plastic cover
- High quality gravity feed slicer
- Belt transmission
- Sharpening accessory included
- CE approved
- Proudly Made in Italy

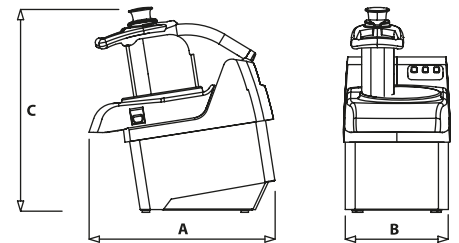

A	B	C	Alimentazione Power supply	Potenza motore / fase Single/Three phase power	Produzione orofa Production per hour	Peso netto Net weight	Dimensioni imballo Packing dimensions
mm	mm	mm	Volt/Hz	Kwatt/Hp	kg	kg	mm
490	280	530	230/50 - 230-400/50	0,58 (0,80)	250-450 kg/h	18,5	580x350x560

TAGLIAVERDURE ÉLITE



DISCHI PER TAGLI ASSORTITI / PLATES FOR VARIOUS OPERATIONS



DISCHI OPZIONALI / AVAILABLE PLATES

DISCHI PER TAGLIO A FETTE / FINE CUT



DISCHI PER TAGLIO A CUBETTI / CUBE CUT

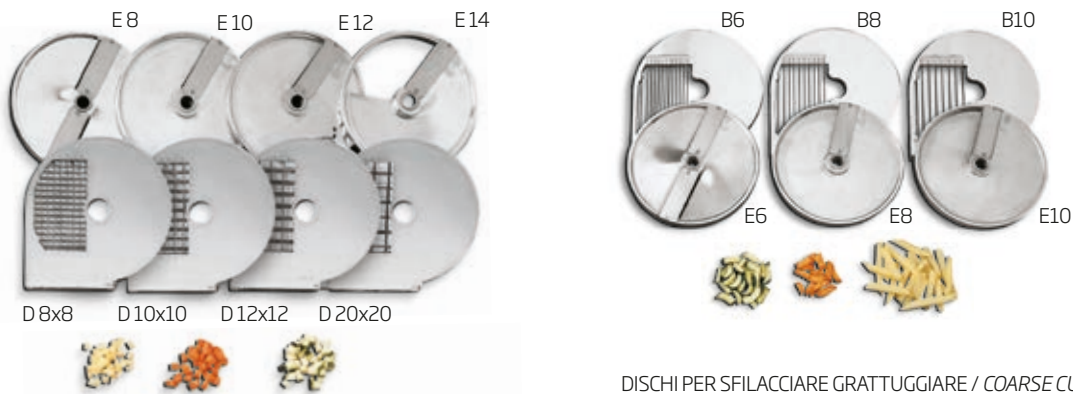

DISCHI PER SFILACCIARE GRATTUGGIARE / COARSE CUT

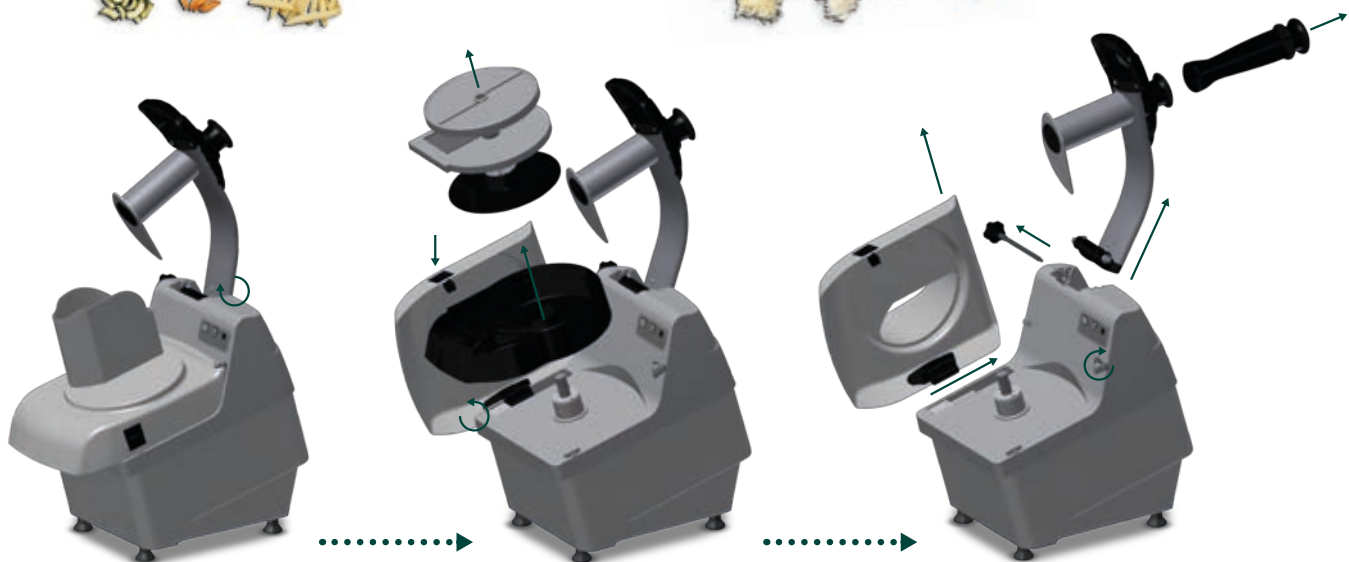

DYNAMIC PROCESSING



TAGLIAVERDURE

VEGETABLE CUTTER



TAGLIAVERDURE

- Apparecchio per uso professionale molto potente
- Ideale per alberghi e ristoranti
- Carena in acciaio inox 304
- Coperchio in acciaio inox smontabile per pulizia
- Grande scelta di dischi per tagli alimenti
- Tastiera digitale
- Robusto motore asincrono ventilato
- Trasmmissione a cinghie
- Microinterruttore di protezione
- Chiusura al basamento
- Pestello in ABS
- Comandi a 24 volt
- Norme CE
- Fabbricato in Italia

- Professional heavy duty equipment
- Ideally suited for hotels and restaurants
- AISI 304 S/steel casing
- S/steel lid easy removable for cleaning
- Different plates available for various operations i.e. dicing, slicing, shredding, grating and chipping
- Digital control panel
- Heavy duty asynchronous ventilated motor
- Belt transmission
- Safety micro switch
- All moving parts fully interlocked giving additional safety to the user
- ABS pestle
- 24volt control panel ensures safety during operation, and gives the operator maximum security
- CE approved
- Proudly Made in Italy

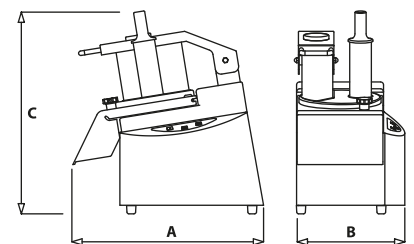

	A	B	C	Alimentazione Power supply	Potenza mono/tri fase Single/Three phase power	Produzione oraria Production per hour	Peso netto Net weight	Dimensioni imballo Packing dimensions
	mm	mm	mm	Volt/Hz	Kwatt/Hp	kg	kg	mm
TAGLIAVERDURE	530	300	480	230/50 - 230-400/50	0,55 (0,75)	200	21,5	600x310x530

DISCHI OPZIONALI / AVAILABLE PLATES

DISCHI PER TAGLIO A FETTE / FINE CUT



DISCHI PER TAGLIO A CUBETTI / CUBE CUT

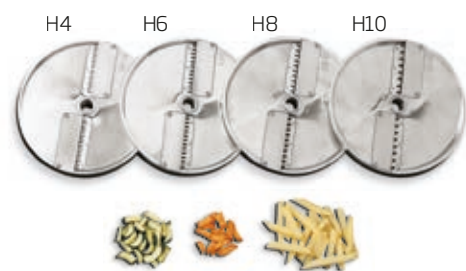
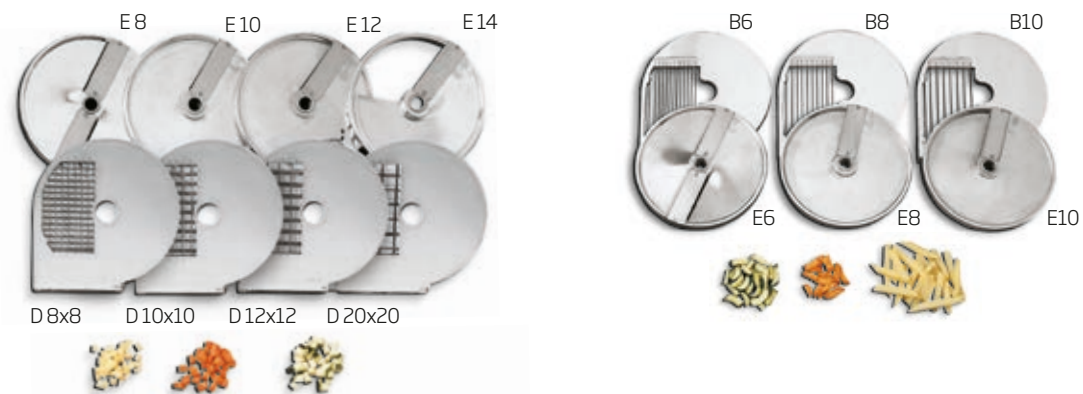

DISCHI PER SFILACCIARE GRATTUGGIARE / COARSE CUT

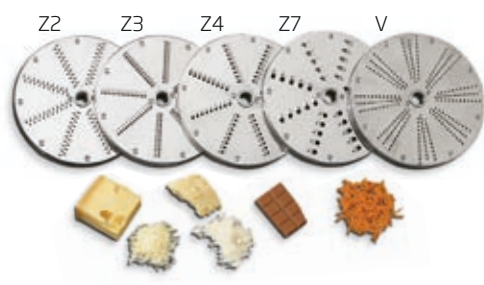



CUTTER

BOWL CUTTERS



L6V

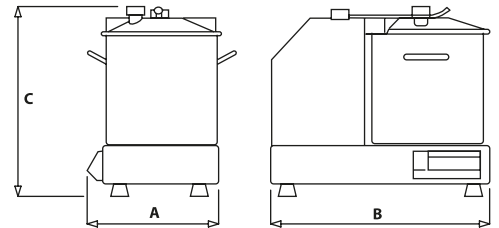

	A	B	C	Alimentazione Power supply	Potenza mono/tri fase Single/Three phase power	Giri motore Motor revolutions	Volume vasca Tank diameter	Peso netto Net weight	Dimensioni imballo Packing dimensions
	mm	mm	mm	Volt/Hz	Kwatt/Hp	g/m	lt.	kg	mm
L4V	160	365	255	230/50 - 230-400/50	0,35(0,5)	1500/2800	3,3	10	450x330x310
L6V	160	365	320	230/50 - 230-400/50	0,35(0,5)	1500/2800	5,3	11	450x330x400
L9V	225	455	380	230/50 - 230-400/50	0,35(0,5)	1500/2800	9,4	23	720x350x500



L4V



L6V



L9V

- Apparecchio per uso professionale molto potente
- Indispensabile in tutte le cucine
- Corpo macchina realizzato in acciaio inox 304
- Vasca estraibile
- Motore asincrono ventilato
- Freno motore
- Termica di protezione
- Micro al coperchio
- Comandi digitali
- Coltelli in acciaio inox
- Coperchio in plastica trasparente
- Norme CE
- Fabbricato in Italia

- *Professional heavy duty equipment*
- *Absolutely necessary tool for any kitchens*
- *Casing entirely made from AISI 304 s/steel*
- *Removable tank*
- *Asynchronous ventilated motor*
- *Motor brake*
- *Thermal overload protection included*
- *Safety micro switch on the lid*
- *Digital controls*
- *S/steel blades*
- *Transparent lid*
- *CE approved*
- *Proudly Made in Italy*

LAMA TAGLIENTE / CUTTING BLADE



passato
di pomodoro
tomato sauce



pane
grattugiato
breadcrumbs



mozzarella
pizza
*mozzarella
grating*



passato
verdure
*vegetables
purée*

LAMA SEGHETTATA / SAW - TOOTHED BLADE



carne
per ragù
meat mincing



frutta secca
*dried
fruit-nuts*

LAMA FORATA / PUNCHED BLADE



maionese
mayonnaise



cioccolato
chocolate



impasti teneri
per dolci
soft mixtures



CUTTER L3 L5 L8

CUTTERS L3 L5 L8



L5



L3



L5



L8

LAMA TAGLIANTE / CUTTING BLADE



passato di pomodoro
tomato sauce

pane grattugiato
breadcrumbs

mozzarella pizza
mozzarella grating

passato verdure
vegetables purée

LAMA SEGHETTATA / SAW - TOOTHED BLADE



carne per ragù
meat mincing

frutta secca
dried fruit-nuts

LAMA FORATA / PUNCHED BLADE



maionese
mayonnaise

cioccolato
chocolate

impasti teneri per dolci
soft mixtures

- Apparecchio per uso professionale molto potente
- Indispensabile in tutte le cucine
- Corpo macchina realizzato in acciaio inox 304
- Vasca estraibile
- Motore asincrono ventilato
- Freno motore
- Termica di protezione
- Micro al coperchio
- Comandi digitali a 24 volt
- Coltelli in acciaio inox
- Coperchio in plastica trasparente
- Norme CE
- Fabbriato in Italia

- Professional heavy duty equipment
- Absolutely necessary tool for any kitchens
- Casing entirely made from AISI 304 s/steel
- Removable tank
- Asynchronous ventilated motor
- Motor brake
- Thermal overload protection included
- Safety micro switch on the lid
- 24 volt digital controls
- S/steel blades
- Transparent lid
- CE approved
- Proudly Made in Italy

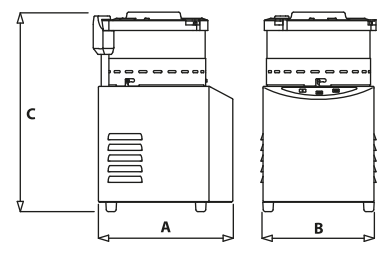

	A mm	B mm	C mm	Alimentazione Power supply Volt/Hz	Potenza mono/tri fase Single/three phase power Kwatt/Hp	Giri motore Motor revolutions g/m	Volume vasca Tank diameter lt	Dimensioni vasca Tank dimensions mm	Peso netto Net weight kg	Dimensioni imballaggio Packing dimensions mm
L3	230	200	410	230/50 - 230-400/50	0,55 (0,75)	1400	3	ø180x105	13,5	350x320x500
L5	310	270	470	230/50 - 230-400/50	1,10 (1,50)	1400	5	ø240x120	22	390x370x600
L8	310	270	540	230/50 - 230-400/50	1,10 (1,50)	1400	8	ø240x180	22	390x370x600
L5 2V	310	270	470	230-400/50	0,67 (1,10)/0,90 (1,50)	700/1400 - 1400/2800	5	ø240x120	22	390x370x600
L8 2V	310	270	540	230-400/50	0,67 (1,10)/0,90 (1,50)	700/1400 - 1400/2800	8	ø240x180	22	390x370x600



TAGLIAMOZZARELLA

MOZZARELLA CHEESE CUTTER



TAGLIAMOZZARELLA

CONO N.1 / CONE N.1

CONO N.2 / CONE N.2



Per affettare mm. 2
Holes mm.2 for slicing



Per grattugiare fori mm. 2,5
Holes mm. 2,5 for shredding or grating



CONO N.3 / CONE N.3

CONO N.4 / CONE N.4



Per verdure fori mm. 4
Holes mm.4 for vegetables



Per mozzarella fori mm. 7
Holes mm.7 for mozzarella cheese



- Apparecchio per uso professionale
- Ideale per pizzerie e ristoranti
- Robusta struttura in lamiera di acciaio inox 304
- Riduttore ingranaggi elicoidali a bagno d'olio
- Robusto motore asincrono di produzione nazionale
- Termica di protezione
- Sportello allo scarico in ABS con micro di protezione
- Cono taglia mozzarella in acciaio inox
- Disponibili varie misure
- Tramoggia e piatto raccolta in acciaio inox
- Pestello in ABS
- Comandi a 24 volt
- Fabbricato in Italia

- Professional equipment
- Ideally suited for pizza shops and restaurants
- Stiffened structure made from AISI 304 s/steel
- Oil immersed gears reducer
- Italian make heavy duty asynchronous motor
- Thermal overload protection included
- ABS discharging chute equippe with safety micro switch
- Stainless steel cutting cones
- Different cutting cones dimensions
- S/steel hopper and tray
- ABS pestle
- 24volt control panel ensures safety during operation, and gives the operator maximum security
- Proudly Made in Italy

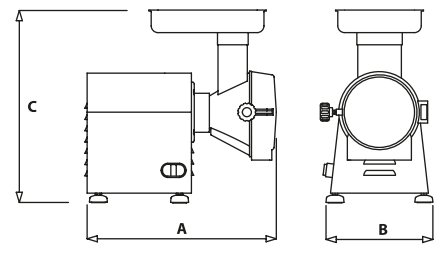

	A	B	C	Alimentazione Power supply	Potenza mono/tri fase Single/three phase power	Giri motore Motor revolutions	Produzione oraria Production per hour	Peso netto Net weight	Dimensioni imballo Packing dimensions
	mm	mm	mm	Volt/Hz	Kwatt/Hp	Giri/Rpm	kg	kg	mm
TAGLIAMOZZARELLA	420	220	440	230/50 - 230-400/50	0,75 (1,00)	1400	50	18	480x300x520



IMPASTACARNE E INSACCATRICI

STAINLESS STEEL MEAT KNEADER AND SAUSAGE FILLERS



IMPASTACARNE

- Struttura in acciaio inossidabile
- Indicato per macellerie
- Potente motore asincrono ventilato
- Centralina a 24 volt
- Ingranaggi elicoidali a bagno d'olio
- Coperchio con micro di sicurezza
- Vasca di lavorazione ribaltabile
- Pala di lavorazione in acciaio inossidabile
- Disponibili ruote - Norme CE - Fabbricato in Italia

- Professional equipment
- Stainless steel bodywork
- Particularly suited for butcheries
- Powerful asynchronous ventilated motor
- 24volt control panel ensures safety during operation, and gives the operator maximum security
- Oil immersed gears - Safety micro switch on the lid
- Folding mixing tank - Stainless steel mixing shovel
- Wheels available - CE approved - Proudly Made in Italy



	A	B	C	Alimentazione Power supply	Potenza Motor power	Capacità Capacity	Peso Netto Net weight
	mm	mm	mm	Volt/Hz	Kwatt/Hp	kg	kg
FIC 30M	360	720	570	230/50 - 230-400/50	0,75 (1,00)	30	40,0
FIC 30MC	360	720	1030	230/50 - 230-400/50	0,75 (1,00)	30	45,0
FIC 50M	460	800	1020	230/50 - 230-400/50	1,50 (2,00)	50	80,0
FIC 50B	565	800	1040	230/50 - 230-400/50	1,80 (2,50)	50	100
FIC 75M	460	980	1020	230/50 - 230-400/50	1,50 (2,00)	75	85
FIC 100B	565	1160	1040	230/50 - 230-400/50	1,80 (2,50)	100	110
FIC 120B	630	1100	1080	230/50 - 230-400/50	1,80 (2,50)	120	120

INSACCATRICI INOX



- Insaccatrice professionale per macellerie
- Struttura in acciaio inossidabile
- Cilindro in acciaio inox 18/8 - AISI 304
- Pistone in alluminio con speciale guarnizione
- Due velocità
- Maniglia lavorazione in alluminio
- Set tre imbuto differenti misure in abs
- Ingranaggi in acciaio
- Cremagliera in acciaio rettificato
- Viteria in acciaio inox
- Norme CE
- Fabbricato in Italia

- Professional sausage filler indispensable for butcheries
- Stainless steel bodywork
- 18/8 - AISI 304 stainless steel cylinder
- Aluminium piston supplied with a special gasket
- Double speed
- Aluminium handle
- ABS funnels kit available in different sizes
- Steel gears
- Rectified steel rack
- Stainless steel bolts and screws
- CE approved
- Proudly Made in Italy

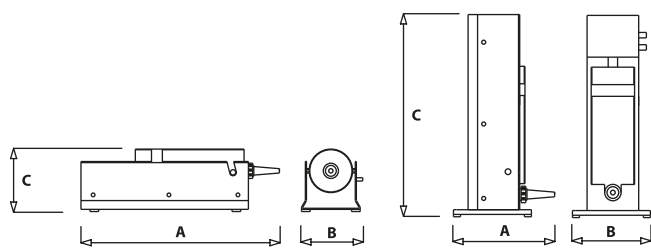

INSACCATRICI INOX

	A	B	C	Cilindro Cylinder	Capacità Capacity	Peso Netto Net weight	Dimensione imbuto Funnels dimensions
	mm	mm	mm	mm	Lt.	kg	mm
L7V	460	300	740	ø156	7	19	300x800x370
L14V	480	350	900	ø198	14	26,5	400x980x400
L7O	800	230	240	ø156	7	19	300x800x370
L14O	980	280	280	ø198	14	26,5	400x980x400
L3ECO	400	200	220	ø136	3	7,5	450x220x240
L5ECO	590	230	240	ø136	5	11	600x250x240
L8ECO	670	335	205	ø136	8	12,5	700x260x240



SEGAOSSA ANODIZZATO **1550**



SEGAOSSA ANODIZZATO **1550**



SEGAOSSA ANODIZZATO **1830**



SEGAOSSA VERNICIATO **1550**

- Apparecchio ad uso esclusivo professionale
- Destinato a macellerie, pescherie, grandi comunità,
- Fusione di alluminio anodizzato o verniciato
- Lama in acciaio di produzione nazionale
- Ampio piano di lavoro in acciaio inossidabile
- Spingi carne - Pulegge calibrate
- Rapido sblocco puleggia superiore
- Tendi lama registrabile
- Micro di protezione - Apparecchio certificato
- Norme CE - Fabbriato in Italia

- *Professional heavy duty equipment*
- *Particularly suited for butcheries, fish shops, large community*
- *Fusion made from anodized or polished aluminium*
- *Italian make Steel blade*
- *Wide stainless steel working surface*
- *Meat pusher - Gauged pulley*
- *Upper pulley easy unlock - Adjustable blade stretcher*
- *Safety micro switch - Certified equipment*
- *CE approved - Proudly Made in Italy*

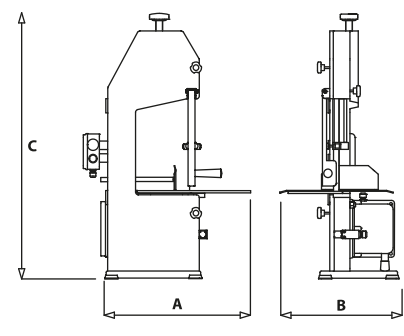
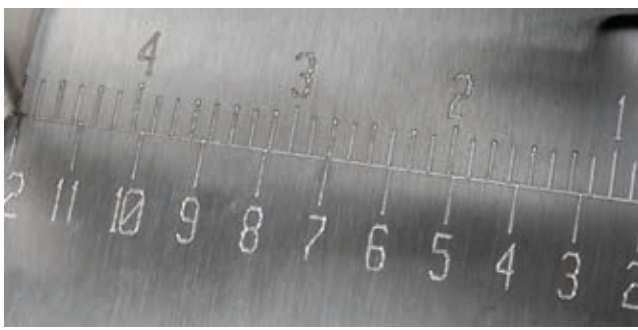

	A	B	C	Alimentazione Power supply	Potenza mono/tri fase Single/three phase power	Altezza taglio Cutting height	Peso netto Net weight	Dimensioni imballo Packing dimensions
	mm	mm	mm	Volt/Hz	Kwatt/Hp	mm	kg	mm
ANODIZZATO 1550	420	350	850	230/50 - 230-400/50	0,75 (1,00)	170	28	640x370x900
ANODIZZATO 1830	500	400	980	230/50 - 230-400/50	0,75 (1,00)	210	38	640x370x1000
VERNICIATO 1550	420	350	850	230/50 - 230-400/50	0,75 (1,00)	170	28	640x370x900
VERNICIATO 1830	500	400	980	230/50 - 230-400/50	0,75 (1,00)	210	38	640x370x1000

SEGAOSSA VERNICIATO 1830



SOTTOVUOTO A BARRA SALDANTE INOX E ABS

INOX AND ABS SEALING BAR VACUUM MACHINE

- Apparecchio per professionale (inox) per uso domestico o semi prof. (ABS)
- Struttura in plastica o in acciaio inox AISI 304
- Aspirazione esterna ad azione manuale
- Elettrovalvola di fine ciclo
- Vacuometro a lancetta con indicazione del tempo reale
- Comandi digitali
- Possibilità di usare sia buste lisce che goffrate
- Pompa per vuoto auto lubrificata che non richiede manutenzione
- Controllo elettronico del ciclo
- Scheda elettronica
- Tensione 220
- Norme CE
- Fabbricato in Italia

- Professional equipment (s/steel) for home or semi-professional use (ABS)
- Structured in plastic or grade AISI 304 s/steel
- Manual external suction
- Cycle ending electric valve
- Needle Vacuum measurer
- Digital display control
- Suitable for smooth and embossed vacuum bags
- Self-lubricated Vacuum pump that won't require routine maintenance
- Electronic process control
- Electronic control board
- 220 voltage
- CE approved
- Proudly Made in Italy



FSV 32IT



FSV 35IT



FSV 45IT



FSV 52IT



FSV 32T

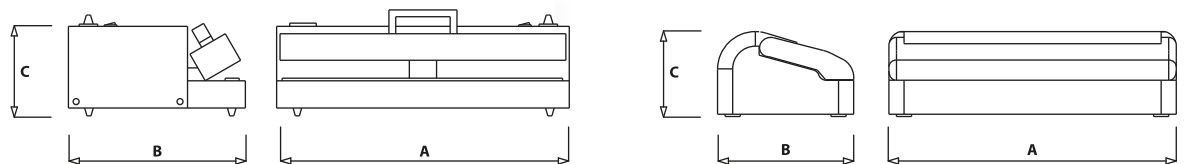

	A	B	C	Alimentazione Power supply	Potenza Motor power	Pompa per vuoto Vacuum pump	Barra Saldante Sealing bar	Peso Netto Net weight	Dimensione imballo Packing dimensions	Struttura Structured in
	mm	mm	mm	Volt/Hz	Watt	L/min	mm	kg	mm	mm
FSV 32IT INOX	360	290	150	230/50	400	15	330	7,0	400x350x200	INOX
FSV 35IT INOX	420	260	140	230/50	450	15	390	7,5	470x315x210	INOX
FSV 45IT INOX	470	260	140	230/50	500	15	450	15,0	640x350x290	INOX
FSV 52IT INOX	690	320	160	230/50	550	30	550	24,0	780x400x320	INOX
FSV 32T ABS	360	300	160	230/50	400	12	330	5,0	400x350x200	ABS
FSV 32D ABS	380	180	110	230/50	300	16	330	3,3	430x240x170	ABS
FSV 32S ABS	380	180	110	230/50	300	16	330	3,2	430x240x170	ABS

SOTTOVUOTO CAMPANA Serie 300 350 400



BELL SHAPED VACUUM MACHINE 300 350 400



400

- Apparecchio per professionale (inox) per uso domestico o semi prof. (ABS)
- Struttura in plastica o in acciaio inox AISI 304
- Aspirazione esterna ad azione manuale
- Elettrovalvola di fine ciclo
- Vacuometro a lancetta con indicazione del tempo reale
- Comandi digitali
- Possibilità di usare sia buste lisce che goffrate
- Pompa per vuoto auto lubrificata che non richiede manutenzione
- Controllo elettronico del ciclo
- Scheda elettronica
- Tensione 220
- Norme CE
- Fabbricato in Italia



350

- Professional equipment (s/steel) for home or semi-professional use (ABS)
- Structured in plastic or grade AISI 304 s/steel
- Manual external suction
- Cycle ending electric valve
- Needle Vacuum measurer
- Digital display control
- Suitable for smooth and embossed vacuum bags
- Self-lubricated Vacuum pump that won't require routine maintenance
- Electronic process control
- Electronic control board
- 220 voltage
- CE approved
- Proudly Made in Italy



300

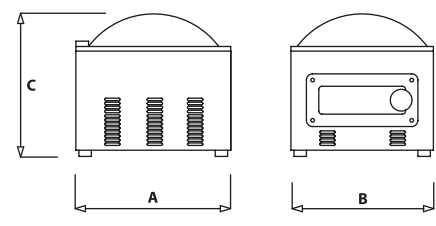

	A	B	C	Alimentazione Power supply	Dimensione Camera Chambre dimensions	Pulsometro Pulsometer	Barra Saldante Sealing bar	Peso Netto Net weight	Dimensione Imballo Packing dimensions
	mm	mm	mm	Volt/Hz	mm	m ³ /h	mm	kg	mm
FSCV 300	450	410	450	230/50	310x350x170	Q=10	300	42	570x660x500
FSCV 350	500	460	420	230/50	360x400x170	Q=12	350	50	570x660x500
FSCV 400	550	500	460	230/50	410x450x200	Q=20	400	55	570x660x500



PRESSHAMBURGER

BURGER PRESS



FHA 400



FHA 100



FHA 400



FHA 500

- Apparecchio per uso professionale
- Per macellerie, ristoranti, alberghi
- Struttura in lega di alluminio alimentare anodizzata
- Porta cellophane incorporato
- Contenitore carne in acciaio inox aisi 304
- Cremagliera in acciaio inox
- Ingranaggi in acciaio - Fondo in plastica
- Attrezzo manuale di semplice utilizzo
- Macchina molto robusta
- Norme CE - Fabbriato in Italia

- Professional equipment
- Ideally suited for restaurant, butcheries, hotels
- Structured in food-grade anodized aluminium alloy
- Cellophane case included
- AISI 304 stainless steel meat bowl
- S/steel rack - Steel gears
- Plastic bottom base - User friendly machine
- Strong equipment
- CE approved - Proudly Made in Italy

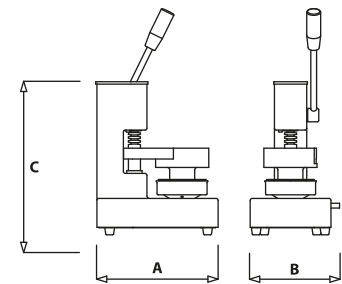
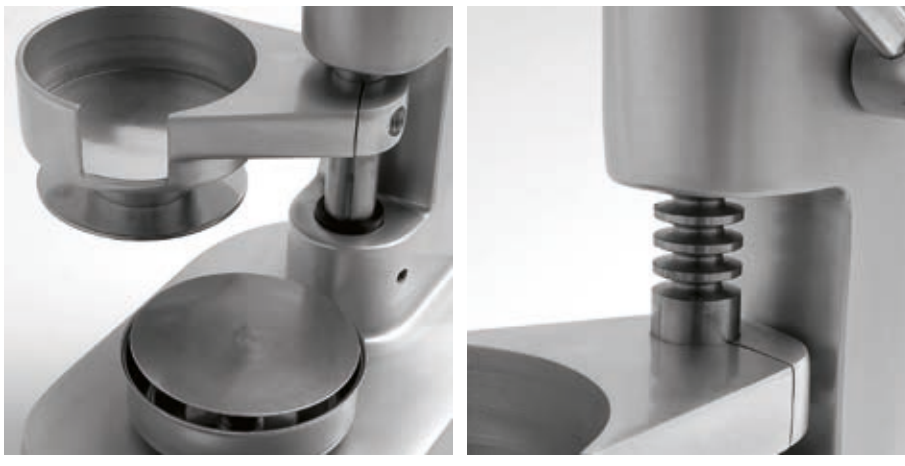

	A	B	C	Cilindro Cylinder	Peso netto Net weight	Dimensioni imballo Packing dimensions
	mm	mm	mm	mm	kg	mm
FHA 100	250	190	320	ø100	5,0	310x270x350
FHA 400	300	190	280	ø130	7,0	360x270x310
FHA 500	300	190	280	ø130	7,0	360x270x310

Panettone / *Panettone* Italian Christmas cake

Lombardia



Preparazione / Directions

Fare una fontana con 150 g di farina, sbriciolarvi la pasta lievitata e scioglierla con acqua tiepida. Incorporare la farina fino a ottenere un composto liscio e morbido. Impastare omogeneamente con la farina, fare una pagnotta e metterlo in una ciotola infarinata. Coprire la ciotola con un canovaccio e lasciarla riposare almeno 3 ore. Dopo questo tempo creare sulla spianatoia la fontana con 130 g di farina, porre la pasta lievitata e impastare con acqua tiepida fino a incorporare tutta la farina. Formare una pagnotta, depositarla nella ciotola infarinata, Coprire la ciotola con un canovaccio e lasciarla riposare 2 ore. Tagliare a cubetti il cedro e l'arancia canditi. Lasciare in acqua tiepida l'uvetta per 20 minuti, scolare e asciugare. Sciogliere in un pentolino 300 g di burro. Versare lo zucchero un'altra casseruola con un po' acqua calda, mescolare sulla fiamma fino a che lo zucchero non sarà sciolto. Unire 12 tuorli e 3 uova intere mescolando con la frusta, dopo aver messo la pentola a bagnomaria in modo lo sciroppo si intiepidisca. Creare una nuova fontana con 1 kg di farina mescolata con 2 cucchiaini di sale, porvi la pagnotta lievitata e incorporare la farina versando il burro fuso. Unire lentamente lo sciroppo. Lavorare a mano per 20 minuti finché la pasta non avrà la consistenza simile a quella del pane (lucida, asciutta, con bollicine) e impastare anche i canditi e l'uvetta. Dividere in tre panetti in una forma leggermente allungata. Disporre i panetti nel forno su un foglio di carta infarinata e imburata e lasciare lievitare al caldo per 6 ore. Quando sarà ora di cuocere nel forno a 200°C, praticare una croce sulla cima dei panettoni. Passati 5 minuti appoggiare alcuni riccioli di burro e continuare la cottura per 70 minuti.

To make sponge, warm a small bowl by rinsing it with hot water. Pour in warm water and sprinkle 1 sachet yeast on it. Let stand until yeast has dissolved. Stir in 60 g of the flour, cover with cling film, and let stand 30 minutes, or until doubled. Sprinkle remaining yeast over warm milk. Let stand until dissolved. Beat together sugar, eggs, egg yolks and vanilla. Stir in milk-yeast mixture. Add sponge and stir until well incorporated. Combine butter and remaining flour until crumbly. Slowly pour in egg mixture and beat on high speed 3 to 4 minutes, until dough is elastic looking and long strands form. Beat in fruit and zests. Turn dough into oiled bowl, cover with cling film, and leave in a warm place to rise until doubled, about 2 to 3 hours. Fold down moulds to form a 7cm cuff. Brush inside and out with melted butter. Turn out dough onto a lightly floured work surface and knead a few times to deflate. Divide dough into 3 pieces. Roll each piece into a ball and drop into prepared moulds. Place bags on a baking tray about 10cm apart and cover loosely with cling film. Let rise in a warm place until doubled again, about 2 hours.

INGREDIENTI / INGREDIENTS

250 g di pasta di pane lievitata	250 g risen bread dough
1350 g di farina bianca	1350 g white flour
400 g di burro	400 g butter
300 g di zucchero	300 g sugar
15 uova	15 egg
200 g di uvetta sultanina	200 g raisins
50 g di cedro candito	50 g candied citron
50 g di arancia candita	50 g candied orange
Sale q.b.	Salt to taste



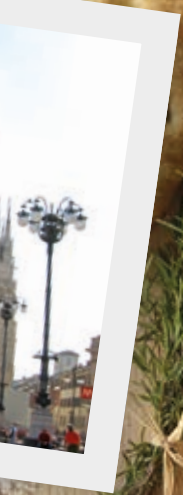

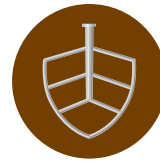

BAKERLINE 10



BAKERLINE 10

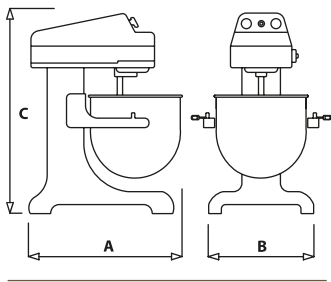

	A mm	B mm	C mm	Alimentazione Power supply Volt/Hz	Potenza Motor power Watt	3 Velocità 3 Speed rpm	Capacità Capacity lt.	Peso Netto Net weight kg	Dimensione Imballo Packing dimensions mm
BAKERLINE 10	420	480	720	230/50 - 380/50	370 Watt (0,50)	95/175/320	10	65,0	450x530x860
BAKERLINE 20	560	570	980	230/50 - 380/50	550 Watt (0,75)	95/175/320	20	98,0	570x630x1010
BAKERLINE 30	585	660	1150	230/50 - 380/50	750 Watt (1,00)	95/175/320	30	198,0	650x730x1220
BAKERLINE 40	630	690	1150	230/50 - 380/50	1100 Watt (1,50)	95/175/320	40	200,0	650x730x1220

- Apparecchi per uso professionale
- Indicati per pasticcerie, ristoranti, alberghi
- Realizzate in metallo verniciato in smalto cotto
- inalterabile nel tempo
- Motore asincrono
- Facilmente lavabili
- Utensili in alluminio
- Frusta in acciaio inox
- Micro alla protezione della vasca di lavorazione
- Contenitore di lavorazione in acciaio inox smontabile
- Movimento planetario in grado di coprire tutto il volume della ciotola
- Trasmissione a ingranaggi
- Termica di protezione attiva

- Professional equipment
- Particularly suitable for bakeries, hotels, restaurants, canteens etc.
- Durable enameled bodywork
- Asynchronous motor
- Easy to clean up
- Comes complete with aluminium beater and dough hook tools stainless steel whisk
- Fully CE approved with an electrically interlocked bowl guard and bowl lift
- Stainless steel removable bowl
- Gear driven planetary mixers with a powerful 3-speed transmission allows constant mixing with step-less speed control
- Gears transmission
- Thermal overload protection included



BAKERLINE 20



BAKERLINE 30



BAKERLINE 40



BakerPK

PK 10



PM 7

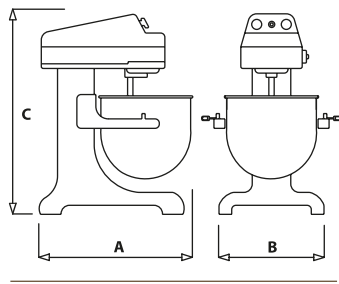

	A mm	B mm	C mm	Alimentazione Power supply Volt/Hz	Potenza Motor power Kwatt/Hp	Velocità Speed rpm	Capacità Capacity lt.	Peso Netto Net weight kg	Dimensione Imballo Packing dimensions mm
PM 7	450	250	420	230/50	0,325 (0,47)	40/250	7,5	15	480x300x500
PK 8	450	300	600	230/50	0,18 (0,25)	58/220	7,6	25,0	350x500x640
PK 10	470	370	770	230/50 - 230-400/50	0,25 (0,33)	58/220	9,5	76,9	500x860x20
PK 20	470	420	870	230/50 - 230-400/50	0,37 (0,50)	40/200	19	93,0	550x680x1030

- Apparecchi per uso professionale
- Indicati per pasticcerie, ristoranti, alberghi
- Realizzate in metallo verniciato in smalto cotto
- inalterabile nel tempo
- Motore asincrono
- Facilmente lavabili
- Utensili in alluminio
- Frusta in acciaio inox
- Micro alla protezione della vasca di lavorazione
- Contenitore di lavorazione in acciaio inox smontabile
- Movimento planetario in grado di coprire tutto il volume della ciotola
- Trasmissione a ingranaggi
- Termica di protezione

- Professional equipment
- Particularly suitable for bakeries, hotels, restaurants, canteens etc.
- Durable enameled bodywork
- Asynchronous motor
- Easy to clean up
- Comes complete with aluminium beater and dough
- Hook tools stainless steel whisk
- Fully CE approved with an electrically interlocked
- Bowl guard and bowl lift
- Stainless steel removable bowl
- Gear driven planetary mixers with a powerful 3-speed
- Transmission allows constant mixing with step-less speed control
- Gears transmission
- Thermal overload protection included



PK 8



PK 10



PK 20



PLANETARIE KITCHENAID

KITCHENAID PLANETARIES

KitchenAid®



PK 5



PK 4,5



PK 5



PK 7

- Apparecchi per uso professionale
- Indicati per pasticcerie, ristoranti, alberghi
- Realizzate in metallo verniciato in smalto cotto
- inalterabile nel tempo
- Motore asincrono
- Facilmente lavabili
- Utensili in alluminio
- Frusta in acciaio inox
- Micro alla protezione della vasca di lavorazione
- Contenitore di lavorazione in acciaio inox smontabile
- Movimento planetario in grado di coprire tutto il volume della ciotola
- Trasmissione a ingranaggi
- Termica di protezione

- Professional equipment
- Particularly suitable for bakeries, hotels, restaurants, canteens etc.
- Durable enameled bodywork
- Asynchronous motor
- Easy to clean up
- Comes complete with aluminium beater and Dough hook tools stainless steel whisk
- Fully CE approved with an electrically interlocked Bowl guard and bowl lift
- Stainless steel removable bowl
- Gear driven planetary mixers with a powerful 3-speed
- Transmission allows constant mixing with step-less speed control
- Gears transmission
- Thermal overload protection included

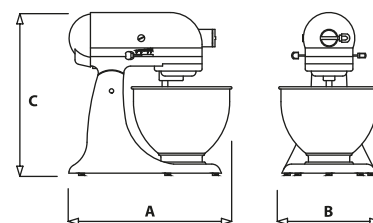

	A	B	C	Alimentazione Power supply	Potenza Motor power	Velocità Speed	Capacità Capacity	Peso Netto Net weight	Dimensione imballo Packing dimensions
	mm	mm	mm	Volt/Hz	Watt	rpm	lt.	kg	mm
PK 4,5	350	220	350	230/240 - 50/60	300 Watt	58/220	4,0	10,5	280x410x410
PK 5	360	280	420	230/240 - 50/60	325 Watt	58/220	4,8	12,0	320x400x500
PK 7	370	340	420	230/240 - 50/60	500 Watt	40/200	6,9	12,2	340x440x500



IKFGA
Tritacarne *Grinder*



IKMVSA
Grattugia a cilindro
Dotata di tre cilindri per:
affettare (verdure), taglio medio
(julienne grattugiare pane), taglio
grosso (mozzarella, grattugiare
parmigiano)
*Slicer with three cylinders:
slice (vegetables), medium cut
(julienne grate bread), coarse cut
(mozzarella, grated parmesan)*



IKSSA
Insaccatrice
Sausage stuffer



IKEMVSC
Set 3 cilindri
per grattugia
sminuzzare finemente,
purè, bastoncini julienne
*3 cylinders set
for grater
Finely chop, mashed potatoes,
julienne sticks*



IKPRA
Set pasta sfogliatrice
+ 2 tagli
(tagliatelle - tagliolini)
*Pasta set sheeter + 2
cuts
(tagliatelle - tagliolini)*



IKPEXTA
Pasta corta 6 trafile
+ accessori
(non disponibile per 6,9 Lt. CE)
*6 pasta extruders
+ accessories
(Not available on 6,9 Lt. CE)*



IKPSA
Rullo sfoglia singolo
Roll pastry single



IKRAV
Set ravioli



IKFVSP
Passatutto
Strainer



IKJE
Spremiagrumi
(non disponibile per 6,9 Lt. CE)
*Juicer
(Not available on 6,9 Lt. CE)*



IKSM1JA
Estrattore lento
*Juicer and sauce
attachment*



IKA5WJ
Vasca termica
(solo per mod. 5 Lt.)
*Thermal bowl
(only for mod. 5 Lt.)*



IKICAOWH
Gelatiera
Ice cream



IKGMA
Mulino cereali
Mill



PK45SBWH
Vasca senza manico
4,28 Lt. per K45
*Bowl with handle
4,28 Lt. for K45*



IK5ASB
Vasca con manico
4,83 Lt. per K50
*Bowl with handle
4,83 Lt. for K50*



IKB3SS
 Vasca senza manico
 3 Lt. per PK45
 Bowl with handle
 3 Lt. for PK45



IKC7SB
 Vasca con manico 6,9 Lt.
 Bowl with handle 6,9 Lt.



IKGB
 Vasca in vetro
 con manico 4,83
 Lt. per K45
 Glass bowl
 with handle 4,83
 Lt. for K45



IK45SBWH
 Vasca con manico
 4,28 Lt. per K45
 Bowl with handle
 4,28 Lt. for K45

ACCESSORI K45
 ACCESSORIES K45



IK45WW
 Frusta
 Whip



IK45B
 Spatola
 Spatula



IK45DH
 Uncino
 Hook



IKN1PS
 Coperchio
 versatore
 Pouring

ACCESSORI K50
 ACCESSORIES K50



IK5AWW
 Frusta
 Whip



IK5AB
 Spatola
 Spatula



IK5ADH
 Uncino
 Hook



IK5APSC
 Coperchio
 versatore
 Pouring



IK5BC5N
 Coperchio
 vasca
 Bowl cover

ACCESSORI K70
 ACCESSORIES K70



IKFE7T
 Spatola con
 bordo
 flessibile
 Soft edge
 spatula



IK7EW
 Frusta
 ellittica
 Elliptical
 whip



IK7SFB
 Spatola
 inox
 S. steel
 spatula



IK7FB
 Spatola
 smaltata
 Enamelled
 spatula



IK7SDH
 Gancio inox
 S. steel
 Hook



IK7DH
 Gancio
 smaltato
 Enamelled
 Hook



IK7PS
 Coperchio
 versatore
 Pouring



IMPASTATRICI A SPIRALE TESTA FISSA

SPIRAL DOUGH MIXER KNEADER



IMPASTATRICE A SPIRALE

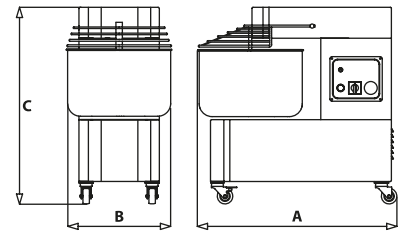

7KG



18KG



25KG

- Apparecchi per uso professionale
- Robusta struttura in acciaio
- Motoriduttore di grande potenza di produzione italiana
- Trasmissione a catena
- Alberi di trasmissione di grosso spessore in acciaio
- Pulegge e corone di produzione nazionale
- Micro meccanico al coperchio
- Vasca, spirale e asta in acciaio inox
- Versioni con vasca estraibile
- Versioni con testa sollevabile
- Ruote con freno di serie
- Facile da pulire
- Comandi a 24 volt
- Norme CE
- Fabbriato in Italia

- Professional equipment Pizzerias, restaurants and other food
- Outlets find it invaluable
- Stainless steel and enameled bodywork
- Powerful and durable Italian make motor reducer
- Heavy duty durable chain transmission dough kneader
- Stiffened Steel Transmission shaft
- Italian make pulley and ring
- Safety micro switch on the lid
- Stainless steel bowl, tank and shaft
- Removable bowl models available
- Head lifts for easy bowl and tool removal
- Wheels with brake included easy to clean
- 24volt control panel ensures safety during operation, and gives the operator maximum security
- CE approved
- Proudly Made in Italy

	A	B	C	Alimentazione Power supply	Potenza mono/tri fase Single/three phase power	Capacità d'impasto Dough output	Capacità farina Flour capacity	Volume vasca Tank diameter	Dimensioni vasca Tank dimensions	Peso netto Net weight	Dimensioni imballo Packing dimensions
	mm	mm	mm	Volt/Hz	Kwatt/Hp	kg	kg	Lt.	mm	kg	mm
7 KG	600	290	610	230/50	0,37 (0,50)	8	5	8	ø240x160	40	380x520x700
18 KG	630	400	700	230/50 - 230-400/50	0,75 (1,00)	18	12	21	ø360x210	59	450x770x840
25 KG	680	440	780	230/50 - 230-400/50	1,10 (1,50)	25	17	32	ø400x260	90	510x790x930
38 KG	800	495	798	230/50 - 230-400/50	1,50 (2,00)	38	25	41	ø450x260	104	570x850x930
44 KG	800	495	798	230/50 - 230-400/50	1,50 (2,00)	44	30	48	ø450x300	109	570x850x930



38KG



44KG



IMPASTATRICI SERIE TESTA SOLLEVABILE

LIFTABLE HEAD DOUGH MIXERS



IMPASTATRICE
TESTA SOLLEVABILE
25KG



18KG



25KG



38KG

- Apparecchi per uso professionale
- Robusta struttura in acciaio
- Motoriduttore di grande potenza di produzione italiana
- Trasmissione a catena
- Alberi di trasmissione di grosso spessore in acciaio
- Pulegge e corone di produzione nazionale
- Micro meccanico al coperchio
- Vasca, spirale e asta in acciaio inox
- Versioni con vasca estraibile
- Versioni con testa sollevabile
- Ruote con freno di serie
- Facile da pulire
- Comandi a 24 volt
- Norme CE
- Fabbriato in Italia

- Professional equipment Pizzerias, restaurants and other food
- Outlets find it invaluable
- Stainless steel and enameled bodywork
- Powerful and durable Italian make motor reducer
- Heavy duty durable chain transmission dough kneader
- Stiffened Steel Transmission shaft
- Italian make pulley and ring
- Safety micro switch on the lid
- Stainless steel bowl, tank and shaft
- Removable bowl models available
- Head lifts for easy bowl and tool removal
- Wheels with brake included easy to clean
- 24volt control panel ensures safety during operation, and gives the operator maximum security
- CE approved
- Proudly Made in Italy

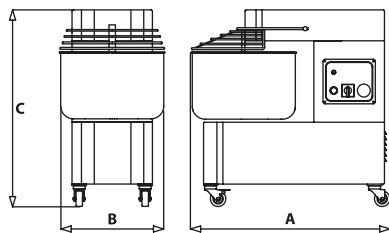

	A	B	C	Alimentazione Power supply	Potenza mono/tri fase Single/three phase power	Capacità d'impasto Dough output	Capacità farina Flour capacity	Volume vasca Tank diameter	Dimensioni vasca Tank dimensions	Peso netto Net weight	Dimensioni imballo Packing dimensions
	mm	mm	mm	Volt/Hz	Kwatt/Hp	kg	kg	lt.	mm	kg	mm
18 KG	630	400	700	230/50 - 230-400/50	0,75 (1,00)	17	12	21	ø360x210	59	450x770x840
25 KG	680	440	780	230/50 - 230-400/50	1,10 (1,50)	25	17	32	ø400x260	90	510x790x930
38 KG	800	495	798	230/50 - 230-400/50	1,50 (2,00)	38	25	41	ø450x260	104	570x850x930
44 KG	800	495	798	230/50 - 230-400/50	1,50 (2,00)	44	30	48	ø450x300	109	570x850x930



44KG





IMPASTATRICI A FORCELLA

FORKED DOUGH MIXERS



25 kg



35 kg

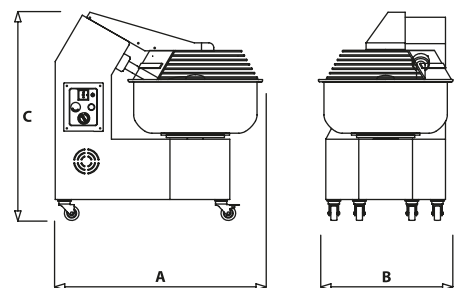

	A	B	C	Alimentazione Power supply	Potenza mono/tri fase Single/three phase power	Capacità d'impasto Dough output	Capacità farina Flour capacity	Volume vasca Tank diameter	Peso netto Net weight	Dimensioni imballaggio Packing dimensions
	mm	mm	mm	Volt/Hz	Kwatt/Hp	kg	kg	lt.	kg	mm
25 Kg	850	550	870	230/50 - 230-400/50	1,10 (1,50)/1,10 (1,50)	25	16	30	140	700x960x1000
35 kg	865	580	870	230/50 - 230-400/50	1,10 (1,50)/1,10 (1,50)	35	23	40	145	700x960x1000



L 30H

- Apparecchi per uso professionale
- Indicato per ristoranti, pizzerie, alberghi, tavole calde
- Struttura in acciaio inox AISI 304
- Riduttore ermetico a bagno d'olio
- Motore ventilato
- Termica di protezione
- Trasmissione a catena
- Regolazione spessore con leva
- Piano di lavoro in acciaio inox
- Disponibile set per tagliare la pasta
- Facile da pulire
- Comandi a 24 volt
- Norme CE
- Fabbricato in Italia

- Professional equipment
- Ideally suited for restaurants, pizza shops, snack bars, hotels
- Stiffened AISI 304
- Oil immersed hermetic gear reducer
- Ventilated motor
- Thermal overload protection
- Chain transmission
- Thicknessing adjusting lever
- S/steel working surface
- Different sized cutting tools available
- Easy clean up
- 24 volt control
- CE approved
- Proudly Made in Italy

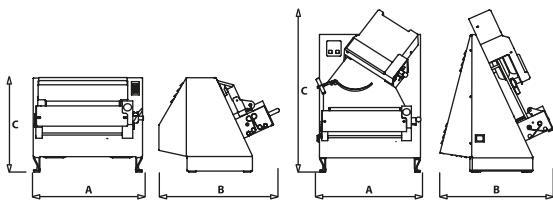

	A	B	C	Alimentazione Power supply	Potenza mono/tri fase Single/three phase power	Peso porzione d'impasto Dough portion size	Diámetro pizza Pizza base diameter	Peso netto Net weight	Dimensioni imballo Packing dimensions
	mm	mm	mm	Volt/Hz	Kwatt/Hp	g	cm	kg	mm
L 30H	420	420	370	230/50	0,38 (0,50)	50/700	10/30	20	510x490x540
L 40H	520	520	370	230/50	0,38 (0,50)	50/700	10/40	25	610x540x950
L 30I	420	420	700	230/50	0,38 (0,50)	50/700	10/30	27,5	510x450x770
L 40I	520	520	800	230/50	0,38 (0,50)	50/1000	10/40	34,5	610x540x950
L 40P	520	520	690	230/50	0,38 (0,50)	50/1000	10/40	35	610x540x950



L 40H

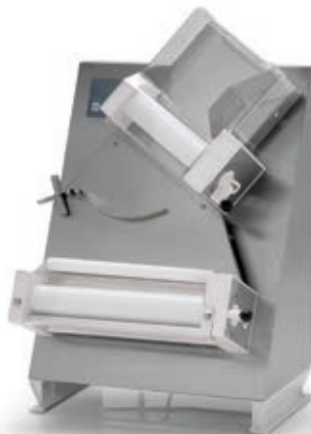

L 30I - L 40I



L 40P



SFOGLIATRICI PER PASTA

DOUGH SHEETER



MANUALE



ELETTRICA



N.1 CAPELLI D'ANGELO
THIN NOODLES mm 1,5



N.2 TAGLIATELLE
TAGLIATELLE mm 2



N.3 TRENETTE
TRENETTE mm 4



N.4 FETTUCCINE
RIBBON-SHAPED PASTA mm 6,5



N.5 LASAGNETTE
LASAGNETTE mm 12



N.6 SPAGHETTI
SPAGHETTI mm ø2



N.7 REGINETTE
REGINETTE mm 12



- Apparecchi per uso professionale
- Indicato per ristoranti, pizzerie, alberghi, tavole calde
- Struttura in acciaio inox AISI 304
- Riduttore a ingranaggi
- Motore ventilato
- Termica di protezione
- Trasmissione a catena
- Regolazione spessore con leva
- Piano di lavoro in acciaio inox
- Disponibile set per tagliare la pasta
- Facile da pulire
- Comandi a 24 volt
- Norme CE
- Fabbricato in Italia

- Professional equipment
- Ideally suited for restaurants, pizza shops, snack bars, hotels
- Stiffened AISI 304
- Gear reducer
- Ventilated motor
- Thermal overload protection
- Chain transmission
- Thicknessing adjusting lever
- S/steel working surface
- Different sizez cutting tools available
- Easy clean up
- 24 volt control
- CE approved
- Proudly Made in Italy

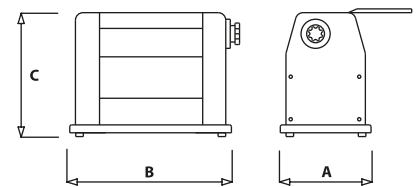

	A	B	C	Alimentazione Power supply	Potenza Motor power	Peso netto Net weight	Dimensioni imballo Packing dimensions
	mm	mm	mm	Volt/Hz	Watt	kg	mm
MANUALE	220	300	250	----	----	11,0	560x470x470
ELETTRICA	350	365	290	230/50	190	16,0	560x470x470



320



- Apparecchi per uso professionale
- Indicato per ristoranti, pizzerie, alberghi, tavole calde
- Struttura in acciaio inox AISI 304
- Riduttore ermetico a bagno d'olio
- Motore ventilato
- Termica di protezione
- Trasmissione a catena
- Regolazione spessore con leva
- Piano di lavoro in acciaio inox
- Disponibile set per tagliare la pasta
- Facile da pulire
- Comandi a 24 volt
- Norme CE
- Fabbricato in Italia

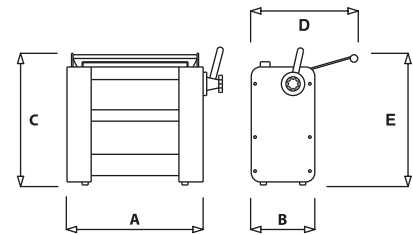

- Professional equipment
- Ideally suited for restaurants, pizza shops, snack bars, hotels
- Stiffened AISI 304
- Oil immersed hermetic gear reducer
- Ventilated motor
- Thermal overload protection
- Chain transmission
- Thickening adjusting lever
- S/steel working surface
- Different size cutting tools available
- Easy clean up
- 24 volt control
- CE approved
- Proudly Made in Italy

	A	B	C	D	E	Alimentazione Power supply	Potenza Motor power	Dimensione rullo Roll dimensions	Peso netto Net weight	Dimensioni imballaggio Packing dimensions
	mm	mm	mm	mm	mm	Volt/Hz	Kwatt/Hp	mm	kg	mm
320	450	210	380	350	420	230/50 - 230-400/50	0,45 (0,60)	ø55x320	41,5	590x360x510
400	540	210	380	350	420	230/50 - 230-400/50	0,45 (0,60)	ø55x400	46,0	590x360x510
500	640	210	380	350	420	230/50 - 230-400/50	0,45 (0,60)	ø55x500	51,5	780x390x620



320



400



500



MF4

MF4D

- FRULLINI
- Apparecchi per uso professionale
- Struttura in alluminio preso fuso e plastica
- Motore ventilato
- Bicchieri in acciaio inox
- Due velocità
- Farfalla in acciaio inox
- Disponibile anche la versione doppia e da muro

- SPREMIAGRUMI
- Apparecchio professionale
- Ideale per bar , ristoranti, piano bar, caffè bar,
- Struttura in alluminio pressofuso e verniciato
- Motore ventilato - Passino in acciaio inox
- Vasca di lavorazione rimovibile in acciaio inox o abs
- Lavaggio vasca in lavastoviglie
- Pigna in abs estraibile per il lavaggio
- Versione a leva per grandi lavorazioni
- Microinterruttore sulla pigna
- Basamento con sottobicchiere salva goccia
- Paraspuzzi di serie nella versione senza leva
- Norme CE
- Fabbricato in Italia

- DRINKS MIXERS
- Professional equipment
- Structured in plastic and pressure die cast aluminium
- Ventilated motor - Grade stainless steel jug
- Two speed included - Stainless steel blending blades
- Double jug and wall mounted options also available

- CITRUS JUICER
- Professional equipment
- Ideally suited small hotel, pub, snack bar, café, club etc
- Structured in pressure die cast and varnished aluminium
- Ventilated motor - Stainless steel juice filter
- Removable stainless steel or ABS container
- Tank suitable for dishwasher
- Removable ABS reamer for easy and effective cleaning
- Lever model recommended heavy processing
- Safety switch activating
- Drip-saving saucer base
- Polycarbonate splash guard included for leverless models
- CE approved
- Proudly Made in Italy



MSP2

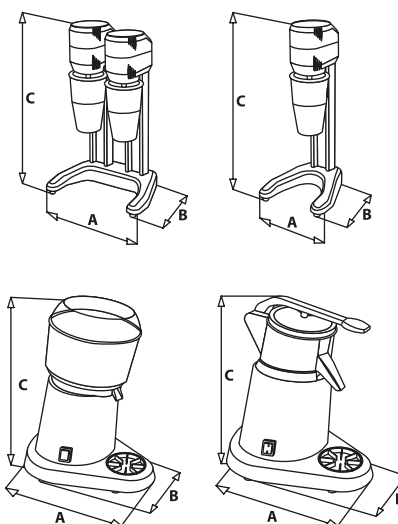

	A	B	C	Alimentazione Power supply	Potenza Motor power	Velocità Speed	Capacità Capacity	Contentitore Jug	Opilva Reamer	Peso netto Net weight	Dimensioni imballaggio Packing dimensions
	mm	mm	mm	Volt/Hz	Watt	rpm	mm	mm		kg	mm
MF4D	340	220	500	230/50	140x2	15000	0,9x2	----	----	5,5	440x300x700
MF4T	200	220	500	230/50	140	15000	0,9	----	----	3,0	300x300x600
MF4DT	340	220	500	230/50	140x2	15000	0,9x2	----	----	5,0	440x300x700
MF4	200	220	500	230/50	140	15000	0,9	----	----	3,0	300x300x600
MSE	320	220	360	230/50	300	1400	----	220 /abs	abs	5,5	400x300x440
MSP	320	220	360	230/50	300	1400	----	220/inox	abs	6,5	400x300x440
MSP2	320	220	360	230/50	340	1400	----	110/inox	inox	8,0	380x300x440



MSE



MSP



MSP2



FRULLATORI

BLENDERS



MT 1



MT1



MT1D



MTQ



MTFIVE

- Apparecchi professionali per bar moderni
- Robusta struttura in alluminio pressofuso e verniciato
- Motore ventilato
- Bicchiere in poliestere infrangibile lavabile in lavastoviglie
- Disponibile anche in acciaio inox
- Quattro lame in acciaio inox
- Due velocità di serie
- Trasmmissione in gomma vulcanizzata
- Micro al coperchio del bicchiere
- Curato nei particolari
- Linea filante per una facile pulizia
- Norme CE
- Fabbricato in Italia

- Professional equipment
- Structured in a strong pressure die cast varnished aluminium
- Ventilated motor
- Infrangible polyester jug suitable for dishwasher
- Stainless steel option available
- 4 Strong stainless steel blades
- 2 speed option included
- Vulcanized rubber transmission
- Safety micro switch assembled on the jug
- High grade finishing
- Jug and all other parts in contact with food removable for easy cleaning
- CE approved
- Proudly Made in Italy

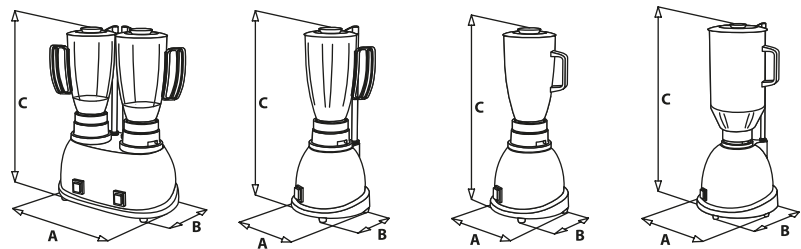

	A	B	C	Alimentazione Power supply	Potenza Motor power	Velocità Speed	Capacità Capacity	Peso netto Net weight	Dimensioni imballaggio Packing dimensions
	mm	mm	mm	Volt/Hz	Watt	rpm	Lt.	kg	mm
MT1	200	200	470	230/50	400	10000/15000	1,7	4,0	300x300x600
MT1D	350	200	470	230/50	400x2	10000/15000	1,7x2	7,5	500x300x600
MTQ	208	210	485	230/50	750	14000/24000	2,0	5,0	310x300x530
MTFIVE	245	260	540	230/50	750	14000/24000	5	7,0	340x330x640
MT1I	200	200	470	230/50	400	10000/15000	1,7	4,0	440x300x700
MT1DI	350	200	470	230/50	400x2	10000/15000	1,7x2	7,5	500x300x600
MT5	230	230	550	230/50	800	3000	5,4	10,0	440x300x700



MT1I



MT1DI



MT5



FRULLATORI

BLENDERS



- Apparecchi per uso professionale
 - Ideali per bar, piano bar, discoteche, pub
 - Struttura in alluminio verniciato
 - Particolari in acciaio inox
 - Campane in plastica trasparente
 - Disponibili in acciaio inox
 - Motori ventilati
 - Costruiti in Italia
 - Passino in acciaio inox
 - Vasca di lavorazione agrumi rimovibile in acciaio inox
 - Campana in poliestere infrangibile lavabile in lavastoviglie
 - Norme CE
 - Fabbriato in Italia
- Professional equipment
 - Ideally suited for bar, restaurant, pub, club, etc
 - Structured in varnished aluminium
 - Stainless steel finishing
 - Transparent plastic tank
 - Stainless steel option is also available
 - Ventilated motors
 - Italian make
 - Stainless steel filter
 - Removable s/steel reamer
 - Infrangible polyester tank suitable for dish washer
 - CE approved
 - Proudly Made in Italy

MG13

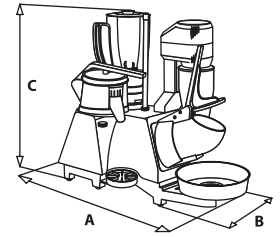
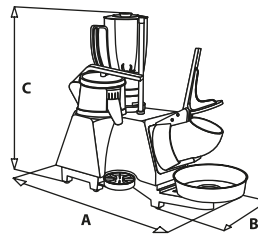
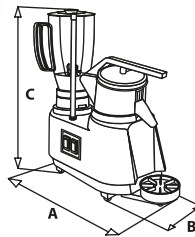

	A	B	C	Alimentazione Power supply	Potenza frullatore Blender power	Potenza trita ghiaccio Ice shaver power	Potenza frullino Spindle mixer power	Potenza spremiagrumi Fruit juicer power	Peso netto Net weight	Dimensioni imballo Packing dimensions
	mm	mm	mm	Volt/Hz	Watt	Watt	Watt	Watt	kg	mm
MG13	440	200	470	230/50	400	---	---	340	14,0	500x310x600
MG20	570	320	530	230/50	400	340	---	340	24,0	600x440x600
MG50	570	320	530	230/50	400	340	140	340	26,0	600x440x600



MG13



MG20



MG50



- TRITAGHIACCIO
 - Apparecchio professionale per bar, ristoranti, hotel
 - Ideale per tritare il ghiaccio per granite
 - Struttura in alluminio presso fuso verniciato
 - Micro di sicurezza al manico della bocca di carico
 - Lame taglia ghiaccio in acciaio inox
 - Motore ventilato - Norme CE
 - Fabbricato in Italia
- CENTRIFUGA
 - Apparecchio per uso professionale
 - Bar, pensioni, alberghi, hotel, cucine
 - Completamente in alluminio anodizzato
 - Filtro e lame in acciaio inossidabile
 - Coperchio in plastica lavabile
 - Cestello in acciaio inossidabile lavabile
 - Micro di protezione
 - Pestello in plastica
 - Motore asincrono ventilato
 - Velocità contenuta per salvaguardia proteine alimento
 - Scheda elettronica - Pulsante digitale
 - Copertura in plastica al fondo
 - Norme CE - Fabbricato in Italia
- ICE SHAVER
 - Ideally suited for hotels, bar, restaurants, etc
 - Prepares ice for the preparation of slush drinks
 - Structured in varnished pressure die cast aluminium
 - Safety micro switch assembled on the loading handle
 - Grade s/steel cutting blades
 - Ventilated motor
 - CE approved - Proudly Made in Italy
- CENTRIFUGAL JUICE EXTRACTOR
 - Professional equipment
 - Ideally suited for bar, hotels, restaurants, pub
 - Entirely made from anodized aluminium
 - Blade and filter made from stainless steel
 - Plastic lid suitable for dish washer
 - Easy clean up stainless steel juicer basket
 - Safety micro switch - Plastic pestle
 - Asynchronous ventilated motor
 - Speed turning designed to save food proteins while processing
 - Electronic control board
 - Digital on/off switch
 - Bottom base plastic cover
 - CE approved - Proudly Made in Italy

MSG100

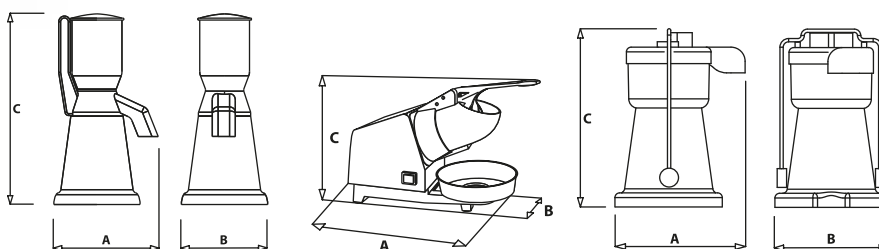

	A	B	C	Alimentazione Power supply	Potenza Motor power	Contenitore Jug	Giri Revolutions	Peso netto Net weight	Dimensioni imballo Packing dimensions
	mm	mm	mm	Volt/Hz	Watt	mm	rpm	kg	mm
MSG100	300	220	520	230/50	450	-----	1400	11,5	710x280x440
MTG6	420	210	320	230/50	340	-----	1400	9,5	500x330x400
MCF100	350	260	440	230/50	400	ø180 - h270	8,0	14,0	470x300x530



MSG100



MTG6



MCF100



MACINA CAFFÈ E GRATTUGIA

COMBO COFFEE GRINDER AND GRATER



CS



CS



CD



GC



GCP

- Apparecchio per uso professionale
- Ideale per negozi, bar, alberghi
- Struttura in alluminio lucidato o verniciato
- Campana in plastica infrangibile
- Regolazione manuale alla campana
- Macine in acciaio rettificato
- Manopola regolazione spessore taglio
- Ferma sacchetto
- Pulsante avviamento digitale
- Scheda elettronica a 24 vol
- Dosatore per caffè (FMX)
- Norme CE
- Fabbriato in Italia

- Professional equipment
- Ideally suited for hotel, restaurant, shops
- Structured in polished or varnished aluminium
- Infrangible plastic bowl
- Manual Adjustable bowl lever
- Rectified steel grindstone
- Adjustable cut thickening knob
- Bag locking
- Digital starting button
- 24 vol control board
- FMX comes with coffee doser included
- CE approved
- Proudly Made in Italy

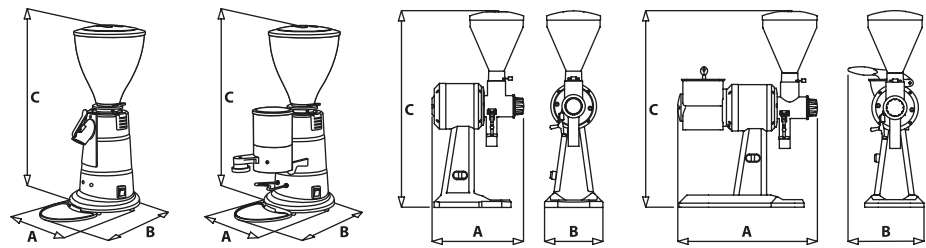

	A	B	C	Alimentazione Power supply	Potenza Motor power	Dimensioni mola Grinding wheel dimensions	Giri Revolutions	Produzione oraria caffè/pepe Coffee/pepper production per hour	Produzione oraria formaggio Cheese production per hour	Peso netto mono/tri fase Net weight single/three phase	Dimensioni imballo Packing dimensions
	mm	mm	mm	Volt/Hz	Kwatt/Hp	mm	rpm	kg	kg	kg	mm
FMC6	220	360	600	230/50	340	ø 65	1400	3/4	----	10,0	440x300x700
FMX	220	360	600	230/50	340	ø 65	1400	3/4	----	11,5	440x300x700
FMXT	220	360	600	230/50	340	ø 65	1400	3/4	----	11,5	440x300x700
FMXA	220	360	600	230/50	340	ø 65	1400	3/4	----	12,0	440x300x700
CS	350	220	720	230/50 - 230-400/50	0,75 (1,00)	ø 65	1400	10,0	----	26,0/26,0	590x300x420
CD	500	220	720	230/50 - 230-400/50	0,75 (1,00)	ø 65	1400	10+10	----	29,0/29,0	700x410x510
GC	500	260	650	230/50 - 230-400/50	0,75 (1,00)	ø 65	1400	10,0	50,0	32,0/32,0	700x400x510
GCP	650	260	650	230/50 - 230-400/50	0,75 (1,00)	ø 65	1400	10,0	50,0	52,0/52,0	700x400x510



FMC6



FMX



FRIGGITRICI

FRYERS



MFR40



MFR240



MFR80



MFR280

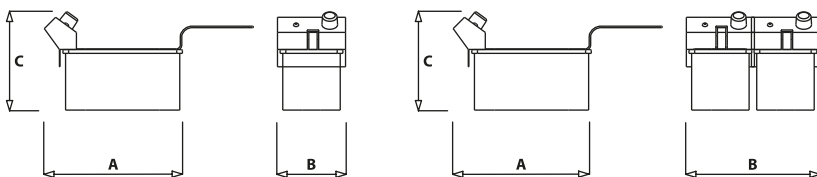

	A	B	C	Alimentazione Power supply	Potenza Motor power	Dimensioni vasca Tank dimension	Vasche Tank	Peso Weight	Dimensioni imballo Packing dimensions
	mm	mm	mm	Volt/Hz	Watt	mm	Lt.	Kg.	mm
MFR40	430	245	310	230/50-60	2000	140x240x100	4,0	5,0	500x270x340
MFR240	430	430	310	230/50-60	2000x2	140x240x100	4,0+4,0	8,5	480x440x380
MFR80	430	340	310	230/50-60	3250	220x240x100	8,0	6,0	520x400x350
MFR280	430	620	310	230/50-60	3250x2	220x240x100	8,0+8,0	11,0	600x500x400



MFR80R



MFR280R



MFR10R



MFR210R

- Apparecchio per uso professionale
- Indispensabile per bar, alberghi, tavole calde, ristoranti
- Struttura realizzata con lamiera di acciaio inossidabile
- Vasca di cottura in acciaio inossidabile con rubinetto
- Vasca estraibile per lavaggio
- Coperchio salva spruzzi in acciaio inox con maniglia in plastica
- Capiente cestello in rete con manico per facile estrazione
- Resistenze a lunga durata
- Raggiungimento temperatura immediato
- Norme CE
- Fabbricato in Italia

- Professional equipment
- Ideally suited for restaurant, pub, snack bar
- Structured in s/steel plate
- Frying tank made from s/steel with tap
- Removable tank for cleaning
- S/steel splash guard with plastic handle
- Easy pull-out and capacious reticulated basket with handle
- Heavy duty Heating elements
- Fast oil heating
- CE approved
- Proudly Made in Italy

	A	B	C	Alimentazione Power supply	Potenza Motor power	Dimensioni vasca Tank dimension	Vasche Tank	Peso Weight	Dimensioni imballo Packing dimensions
	mm	mm	mm	Volt/Hz	Watt	mm	Lt.	Kg.	mm
MFR80R	430	340	355	230/50	3250	220x240x100	8,0	7,0	550x380x400
MFR280R	430	560	355	230/50	3250x2	220x240x100	8,0+8,0	15,5	600x500x400
MFR10R	480	300	360	230/50	3500	220x240x100	10,0	8,5	600x340x420
MFR210R	480	600	360	230/50	3500x2	220x240x100	10,0+10,0	16,0	620x600x440



FRIGGITRICI

FRYERS



MFR12R



MFR212R



MFR12M



MFR212M

- Apparecchio per uso professionale
- Indispensabile per bar, alberghi, tavole calde, ristoranti
- Struttura realizzata con lamiera di acciaio inossidabile
- Vasca di cottura in acciaio inossidabile con rubinetto
- Vasca estraibile per lavaggio
- Coperchio salva spruzzi in acciaio inox con maniglia in plastica
- Capiente cestello in rete con manico per facile estrazione
- Resistenze a lunga durata
- Raggiungimento temperatura immediato
- Norme CE
- Fabbricato in Italia

- Professional equipment
- Ideally suited for restaurant, pub, snack bar
- Structured in s/steel plate
- Frying tank made from s/steel with tap
- Removable tank for cleaning
- S/steel splash guard with plastic handle
- Easy pull-out and capacious reticulated basket with handle
- Heavy duty Heating elements
- Fast oil heating
- CE approved
- Proudly Made in Italy

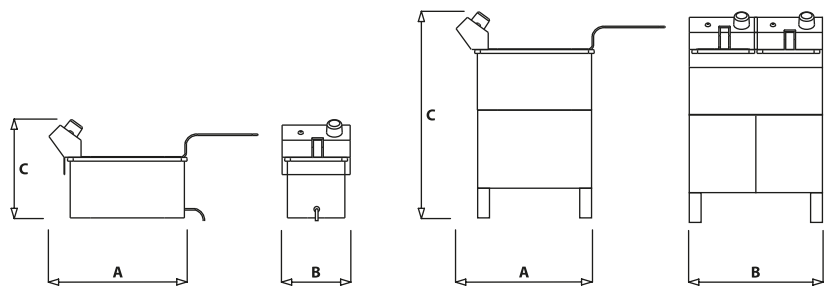

	A	B	C	Alimentazione Power supply	Potenza Motor power	Dimensioni vasca Tank dimension	Vasche Tank	Peso Weight	Dimensioni imballo Packing dimensions
	mm	mm	mm	Volt/Hz	Watt	mm	Lt.	Kg.	mm
MFR12R	400	700	420	400/50/60	9000	210x280x120	12	18,4	800x500x600
MFR212R	800	700	420	400/50/60	9000x2	210x280x120	12+12	36,0	870x780x600
MFR12M	400	700	960	400/50/60	9000	210x280x120	12	27,5	720x430x108
MFR212M	800	700	960	400/50/60	9000x2	210x280x120	12+12	54,2	900x800x108



PIETRA LAVICA

LAVA STONE

- Realizzata in acciaio inox AISI 304
 - Riscaldamento tramite bruciatori in acciaio a fiamma stabilizzata con bruciatore pilota e termocoppia di sicurezza.
 - Erogazione del gas controllata da un rubinetto valvolato di sicurezza.
 - Griglia di cottura in ghisa
 - Cassetto raccogli grassi esterno al top ed estraibile per una migliore pulizia.
 - Versione da appoggio
 - Potenza gas 5,5 KW / 11 KW
 - In dotazione: 1 griglia carne.
-
- *Manufactured in AISI 304 s/steel*
 - *Heated by s/steel stabilized flame burners with leading burner and thermal coupling.*
 - *Tap gas nozzle with safety valve*
 - *Cast iron grilling surface*
 - *Removable stainless steel drip tray for easy cleaning*
 - *Counter top model*
 - *5.5 KW / 11 KW Gas power*
 - *Supplied with one grill for meat*



FPL 60/30



FPL 65/40



FPL 60/60



FPL 65/70



FPL 60/30 B



FPL 65/40 B2

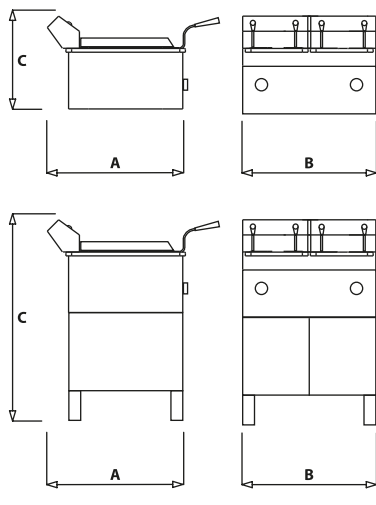

	A	B	C	Altezza supporto Cabinet height	Potenza gas Gas power	Bruciatori Burners	Peso Weight	Peso Supporto Cabinet Weight	Dimensioni imballo Packing dimensions	Dimensioni imballo supporto Cabinet Packing dimensions
	mm	mm	mm	mm	kW		Kg.	Kg.	mm	mm
FPL 60/30	280	360	600	---	5,5	1	18	---	350x660x560	---
FPL 65/40	280	400	560	---	5,5	1	58	---	650x660x560	---
FPL 60/60	280	600	600	---	11	2	45	---	450x690x560	---
FPL 65/70	280	700	650	---	11	2	59	---	750x690x560	---
FPL 60/30 B	280	360	600	920	5,5	1	18	12,5	350x660x560	300x600x920
FPL 65/40 B	280	400	560	920	5,5	1	58	16	650x660x560	400x650x920
FPL 60/60 B2	280	600	600	920	11	2	45	14	450x690x560	600x600x920
FPL 65/70 B2	280	700	650	920	11	2	59	17	750x690x560	700x650x920

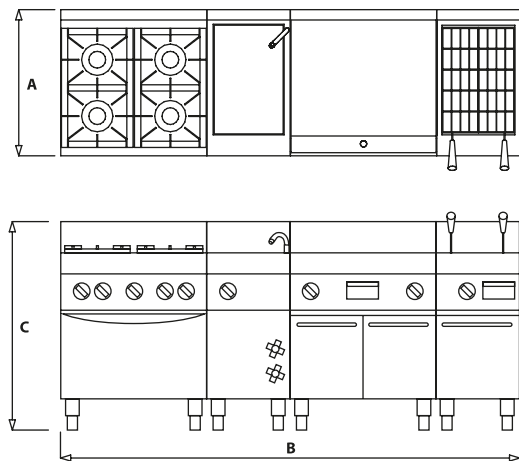

	A	B	C	Alimentazione Power supply	Potenza bruciatori Burners Power	Potenza forno Oven power	Uscia Tank	Peso Weight	Dimensioni imballo Packing dimensions
	mm	mm	mm	Volt/Hz	kW	kW	Lt.	Kg.	mm
7070 CFG CUCINA 4 FUOCHI SU FORNO GAS	700	700	850	000	2x3,7+2x5,5	5	---	64	740x740x1170
7040 CPG CUOCIPASTA GAS CESTI ESCLUSI	700	400	850	000	11,8	---	40	50	440x740x1170
7070 FTG-P FRYTOP GAS PIASTRA LISCIA SU VANO CON PORTE	700	700	850	000	11,4	---	---	85	740x740x1170
7040 GRL-P GRIGLIA A PIETRA LAVICA CON PORTA	700	400	850	000	7,5	---	---	64	440x740x1170



FORNI CONVEZIONE

CONVECTION OVENS

■ FORNI A CONVEZIONE

- Forno elettrico a Convezione con pulsante umidificatore, interno ed esterno realizzati in acciaio Inox.
- Elevato isolamento termico da 50mm
- Camera di cottura saldata con angoli arrotondati, porta doppio vetro (4mm), vetro, base della camera di cottura diamantata per facilitare lo scarico della condensa interna, cremagliera teglie removibile, passo teglie 75mm, 2 ventole autoreverse da 2800giri/min.
- Maniglia ergonomica, riscaldamento elettrico tramite potenti resistenze posizionate dietro il deflettore
- Pannello di controllo: regolazione temperatura da 10 a 280°C - regolazione tempo da 1 a 120
- Pulsante umidificatore manuale

■ CONVECTION OVENS

- *Electrical convection oven with humidifier switch, stainless steel inside and outside.*
- *High performing 50 mm thermal insulation.*
- *Welded cooking chamber with rounded corners, double glass door (4 mm) with ergonomic handle, diamond wired cooking chamber base for easy condensation discharge, removable tray for collection of liquefied waste, 75 mm griddle pitch, 2800rpm two-directional wheel fan.*
- *Heating is transferred by two powerful electric resistances placed behind deflector.*
- *Control panel: 10 to 280°C thermal range control. 1 to 120 timer*
- *Manual humidifier switch.*



FFM100S
FFM101G
FFM102U



FFM103C



DECS11M

■ FORNI A MICROONDE

- Apparecchi per uso professionale
- Ideali per bar, ristoranti, alberghi
- Interamente in acciaio inox
- 1100 watt di potenza
- Ampia camera di cottura
- Piatto fisso
- Timer di regolazione
- Apertura porta senza pulsante
- Privi di spigoli
- Norme CE

■ MICROWAVE OVENS

- *Professional equipment*
- *Ideally suited for restaurants, bar, hotels*
- *Structured in s/steel*
- *1100 watt Power*
- *Capacious cooking chamber*
- *Fixed plate*
- *Timer control*
- *Buttonless door releasing*
- *No corners model*
- *CE approved*



FFM103PF



FFM105C

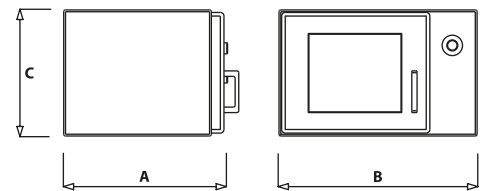

	A	B	C	Alimentazione Power supply	Potenza Motor power	Dimensioni interne Internal dimensions	Temperatura Temperature	Peso Weight	Dimensioni imballo Packing dimensions
	mm	mm	mm	Volt/Hz	kW	mm	°C	Kg.	mm
FFM100S	557	585	568	230/50/60 hz	2,8	433x333	10-280	34,0	670x640x720
FFM101G	557	585	568	230/50/60 hz	2,8	433x333	10-280	35,5	680x600x730
FFM102U	557	585	568	230/50/60 hz	2,8	433x333	10-280	33,5	680x600x730
FFM103C	724	670	598	230/50/60 hz	3,3	4X GN 1/1	10-280	52,0	750x770x770
FFM103PF	825	685	560	230/50/60 hz	6,2	4X GN 1/1	10-280	59,0	850x790x730
FFM105C	825	710	710	400/50/60 hz	7,2	6X GN 1/1	10-280	85,0	880x820x870
DECS11M	480	560	345	230/50 hz	1,0	----	----	15,0	560x650x450



FORNI PER PIZZA

PIZZA OVENS



B1



B1+1



B1 V



B1+1 V



B7



B7+7

	A	B	C	Alimentazione Power supply	Potenza Motor power	Dimensioni interne Internal dimensions	Temperatura Temperature	Peso Weight	Dimensioni imballo Packing dimensions
	mm	mm	mm	Volt/Hz	kW	mm	°C	Kg.	mm
B1	585	480	245	230/50	1,6	410x360x80	50-350	23,0	660x540x330
B1+1	585	480	420	230/50	3,2	410x360x80x2	50-350	37,0	660x540x500
B1 V	555	290	460	230/50	2,2	410x410x110	50-500	26,0	610x610x450
B1+1 V	555	535	460	230/50 - 380	4,4	410x410x110x2	50-500	46,0	610x610x720
B7	715	310	570	230/50 - 380	4,0	500x510x110	50-500	45,0	800x730x450
B7+7	715	550	570	230/50 - 380	8,0	500x510x110x2	50-500	79,0	800x730x900

- Apparecchi per uso professionale
- Ideali per ristoranti, pizzerie e bar
- Struttura in acciaio inossidabile AISI 304
- Sportello con vetro per alte temperature
- Suolo forno in materiale refrattario
- Resistenze corazzate
- Timer al pannello di controllo
- Illuminazione interna
- Temperatura da 50°C a 500°C
- Termostati per il controllo della temperatura
- Isolamento in fibra ceramica
- A richiesta cavalletto in acciaio inox
- Termometro

- Professional equipment
- Ideally suited for restaurants, bar, pizza shops
- Structured in AISI 304 s/steel
- Glass door for high temperature cooking
- Cooking base made from refractory material
- Stiffened heating element
- Timer panel control
- Internal lighting
- Temperature ranging from 50°C up to 500°C
- Thermostat and
- Tiled fibre insulation
- S/steel floor stand (on demand)
- Thermometer



B8



B8+8



B9



B9+9

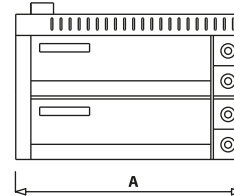
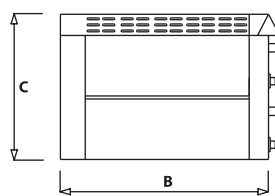
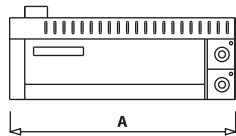
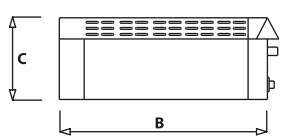

	A	B	C	Alimentazione Power supply	Potenza Motor power	Dimensioni interne Internal dimensions	Temperatura Temperature	Peso Weight	Dimensioni imballo Packing dimensions
	mm	mm	mm	Volt/Hz	kW	mm	°C	Kg.	mm
B8	1010	850	420	230/50 - 380	6,0	720x720x145	50-500	95,0	1090x1040x580
B8+8	1010	850	750	230/50 - 380	12	720x720x145x2	50-500	165,0	1090x1040x930
B9	1010	1210	420	230/50 - 380	9,0	720x1080x145	50-500	137,0	1090x1400x580
B9+9	1010	1210	750	230/50 - 380	18	720x1080x145x2	50-500	232,0	1090x1400x930



FS40



FS70



FS60

Struttura in acciaio inox. I modelli 70 e 60 hanno le resistenze corazzate, mentre il modello 40 ha i tubi al quarzo che garantiscono un utilizzo immediato. I modelli 40 e 60 hanno il regolatore di potenza. Modello 60 con testa mobile.

Stainless steel body. The models 70 and 60 have armored elements, while the model 40 has quartz tubes that guarantee an immediate use. The models 40 and 60 have the power regulator. Model type 60 head up.

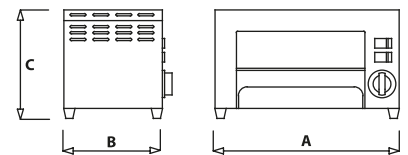

	A	B	C	Alimentazione Power supply	Potenza Motor power	Peso Weight	Dimensioni imballo Packing dimensions
	mm	mm	mm	Volt/Hz	kW	Kg.	mm
FS40	560	360	390	230/50-60	2,2	16,5	560x360x390
FS60	600	480	470	230/50-60	4,0	43,8	600x480x500
FS70	760	360	500	230/50-60	3,2	23,1	760x360x470



Q4



Q6



Q12



Q18

- FORNETTI
- Apparecchi per uso professionale
- Per bar, ristoranti, alberghi
- Struttura in acciaio inossidabile AISI 304
- A riscaldamento veloce
- Ideali per riscaldare panini, pizze, piada e cuocere piccoli crostacei o pesci
- Pinze in acciaio
- Griglie di cottura asportabili
- Cassetto raccolta scarti
- Timer di regolazione
- Norme CE
- Fabbriato in Italia

- SMALL OVENS
- Professional equipment
- Ideally suited for restaurants, bar, hotels
- Structured in AISI 304 s/steel
- Fast Heating
- Recommended for sandwich, pizza, shellfish
- S/steel pliers
- Removable Cooking grate
- Breadcrumbs drawer
- Timer control
- CE approved
- Proudly Made in Italy

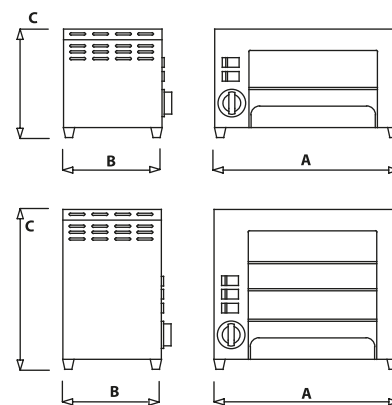

	A	B	C	Alimentazione Power supply	Potenza Motor power	Numero pinze No. of pliers	Peso Weight	Dimensioni Imballo Packing dimensions
	mm	mm	mm	Volt/Hz	kW		Kg.	mm
Q4	320	230	220	230/50	1,2	2	4,0	370x300x300
Q6	430	230	230	230/50	1,9	3	5,5	500x300x300
Q12	430	230	350	230/50	3,0	6	8,5	500x300x430
Q18	430	230	350	230/50	4,0	9	10,0	500x300x440



TOSTAPANE

TOASTER

- TOSTAPANE A PINZA
- Apparecchio ideale per sandwich e fette di pane, disponibile in 2 e 4 pinze
- Solidità della struttura in acciaio inox inossidabile e garanzia di durata nel tempo
- Forni verticali indipendenti
- Coperchio e basamento lucido
- Robuste pinze in acciaio Inox per l'uso (14x14)
- Elementi riscaldanti a lunga durata
- Con sistema autopulente
- Manopola ergonomica soft-touch
- Tensione v. 230/50-60hz

- CLASSICAL TOASTER AVAILABLE WITH 2 OR 4 PLIERS
- Ideal for sandwiches and bread slices
- Robust and durable stainless steel structure
- Polished top and bottom
- Stainless steel robust pliers for professional use
- Independent vertical ovens
- Long-life heating elements with self-cleaning system
- Soft-touch ergonomic knob
- Power 230V 50 & 60 Hz



MTP100



MTP101

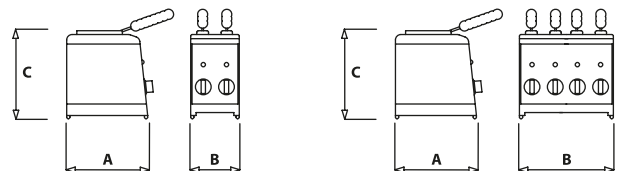

	A	B	C	Alimentazione Power supply	Potenza Motor power	Produzione oraria Production per hour	Peso Weight	Dimensioni imballo Packing dimensions
	mm	mm	mm	Volt/Hz	kW	Pz.	Kg.	mm
MTP100	300	180	300	230/50	1,2	60 fette	4,0	360x250x370
MTP101	300	370	300	230/50	2,4	120 fette	9,0	500x400x460

ROLLER TOAST



ROLLER TOASTER

- ROLLER TOAST
- Apparecchio per uso professionale
- Ottimo per realizzare crostini, pizzette, bruschette, pane tostato
- Necessario per ristoranti, bar, alberghi
- Carena interamente realizzata
- In acciaio inossidabile AISI 304
- Tappeto per tostatura pane in acciaio inox
- Motore ventilato
- Scivoli per pane tostato in acciaio inox lucidato
- Variatore di velocità
- Timer
- Cassetto raccolta briciole
- Design moderno
- Norme CE
- Fabbricato in Italia

- ROLLER TOASTER
- Professional equipment
- Recommended for toasting pizza, bread, crouton
- Particularly suited for restaurant, pub, hotels
- Casing entirely made from AISI 304 s/steel
- S/steel Toasting surface
- Ventilated motor
- Polished stainless steel bread chute
- Speed variator
- Timer control
- Breadcrumbs collecting drawer
- State-of-the-art design
- CE approved
- Proudly Made in Italy



MRT600



MRT700

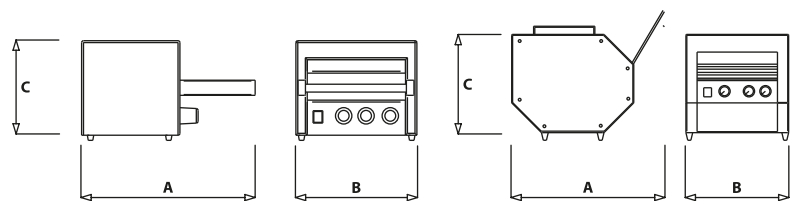

	A	B	C	Alimentazione Power supply	Potenza Motor power	Produzione oraria Production per hour	Peso Weight	Dimensioni imballaggio Packing dimensions
	mm	mm	mm	Volt/Hz	kW	Pz.	Kg.	mm
MRT600	410	340	360	230/50	1,7	600 fette	8,0	500x400x450
MRT700	410	340	360	230/50	2,1	700 fette	15,5	500x400x450



PIASTRE GRILL

SANDWICH GRILLS



PSINGS



PCORTS



PDR3000S



PSING



PCORT



PDR3000

- Apparecchi per uso professionale
- Necessari per bar, ristoranti, alberghi e hotel
- Struttura in acciaio inossidabile
- Cassetto estraibile per raccolta grassi
- Spazzola per pulizia
- Varie dimensioni di piano di lavoro
- Piani di cottura lisci, a righe
- Manopole di regolazione soft-touch
- Piastra superiore regolabile
- Piastre in ghisa smaltate con trattamento ceramico
- Resistenti a ruggine, acidi e sale
- Regolazione temperatura con termostato
- in acciaio inox fino 300°C
- Piastre in vetroceramica a riscaldamento veloce
- 300°C in 3 minuti
- Le piastre in vetro ceramica sono a basso consumo di energia
- Norme CE
- Fabbricato in Italia

- Cast iron and Pyroceram grills
- Professional equipment
- Particularly suitable for restaurant, pub, snack bar
- Structured in stainless steel
- Removable drawer for grease collection
- Brush tool for cleaning
- Wide range of cooking surfaces
- Smooth or ruled cooking surface option available
- Soft-touch control handles
- Adjustable Upper plate
- Enamelled Cast iron grills with ceramic treatment
- Rust and sour resistant
- S/steel Thermostat for temperature setting up to 300° degree
- Pyroceram grills are fast heating ones
- They reach 300° in 3 minutes
- Pyroceram grills are Low Energy input models
- CE approved
- Proudly Made in Italy



*Di serie fornite con piani lisci, ma a richiesta sono disponibili con piano superiore rigato
 *Standard with smooth flats, by request available also the upper flat with ruled surface

***UPM**

UPD

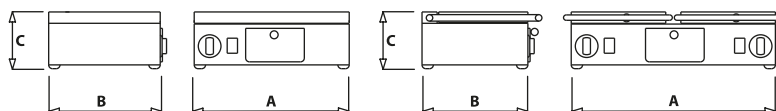

	A	B	C	Piano utile inferiore Bottom plate dimensions	Alimentazione Power supply	Potenza Motor power	Temperatura max Temperature max	Peso Weight	Dimensioni imballo Packing dimensions
	mm	mm	mm	mm	Volt/Hz	kW	°C	Kg.	mm
PSINGS	260	435	235	220x255	230/50	1,55	300	16,0	490x320x330
PCORTS	380	435	235	355x255	230/50	2,1	300	22,0	430x420x270
PDR3000S	515	435	235	500x255	230/50	3,0	300	28,0	560x430x270
PSING	310	380	170	240x290	230/50	1,7	300	13,0	380x380x260
PCORT	450	380	170	230x430	230/50	2,8	300	19,0	590x400x250
PDR3000	630	380	170	245x610	230/50	3,5	300	28,0	800x400x260
UPM	410	480	210	280x380	230/50	2,1	300	13,0	500x500x270
UPD	640	480	210	280x585	230/50	3,2	300	21,5	730x500x290

Piano utile
Plate dimensions
mm

Alimentazione
Power supply
Volt/Hz

Potenza
Motor power
kW

Peso
Weight
Kg.



PFIND30



PFIND35

PFIND30 INDUZIONE	ø 225	230/50	3,0	4,5
PFIND35 INDUZIONE	ø 240	230/50	3,5	4,5



CREPIERA ELETTRICA

PANCAKE MACHINE

- Apparecchio ad uso professionale
 - Ideale per bar, ristoranti, alberghi
 - Struttura in acciaio inox
 - Timer di regolazione
 - Led di controllo al pannello
 - Cavo di collegamento ignifugo
 - Piatto in ghisa
 - Distribuzione termica omogenea
 - Resistenze corazzate
 - Forma compatta
 - Poco ingombro
 - Norme CE
 - Fabbricato in Italia
- Professional equipment
 - Particularly suited for restaurants, pub, hotels
 - Structured in s/steel
 - Timer control
 - LED Panel control
 - Fireproof cable
 - Cast iron cooking surface
 - Homogeneous heating
 - Stiffened heating element
 - Compact shape
 - Reduced overall dimensions
 - CE approved
 - Proudly Made in Italy



CPS



CPD

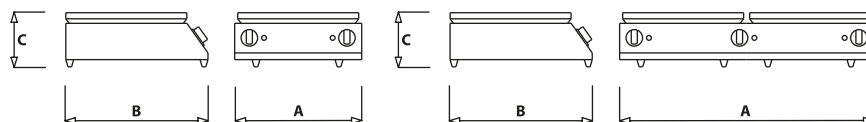

	A	B	C	Alimentazione Power supply	Potenza Motor power	Temperatura Temperature	Diámetro Diameter	Peso Weight	Dimensioni Imballo Packing dimensions
	mm	mm	mm	Volt/Hz	kW	°C	mm	Kg.	mm
CPS SINGOLA 35	370	420	160	230/50 monofase	2,4	70-300	350	13,0	440x500x240
CPS SINGOLA 40	470	420	160	230/50 monofase	2,4	70-300	400	18,0	440x500x240
CPD DOPPIA	760	420	160	230-400/50 trifase	4,8	70-300	400x2	36,0	440x900x240

- Apparecchi per uso professionale
- Necessari per bar, ristoranti, alberghi e hotel
- Struttura in acciaio inossidabile
- Cassetto estraibile per raccolta grassi
- Varie dimensioni di piano di lavoro
- Manopole di regolazione soft-touch
- Resistenti a ruggine, acidi e sale
- Piastre in vetroceramica a riscaldamento veloce
- Le piastre in vetro ceramica sono a basso consumo di energia
- Norme CE
- Fabbricato in Italia

- Professional equipment
- Particularly suitable for restaurant, pub, snack bar
- Structured in stainless steel
- Removable drawer for grease collection
- Wide range of cooking surfaces
- Soft-touch control handles
- Rust and sour resistant
- Pyroceram grills fast heating
- Pyroceram grills are Low Energy input models
- CE approved
- Proudly Made in Italy



PFT3040V



PFT3060V



PFTM



PFTD

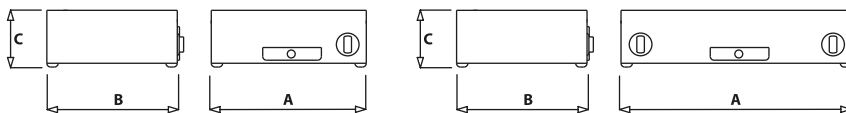

	A	B	C	Piano utile inferiore Bottom plate dimensions	Alimentazione Power supply	Potenza Motor power	Temperatura max Temperature max	Peso Weight	Dimensioni imballaggio Packing dimensions
	mm	mm	mm	mm	Volt/Hz	Watt	°C	Kg.	mm
PFT3040V	440	365	135	300x400	230/50	1500	0-300	7,5	500x440x210
PFT3060V	630	465	135	400x600	230/50	3000	0-300	14,5	690x550x200
PFTM	360	340	150	280x360	230/50	1,1	-	7,5	500x500x290
PFTD	520	580	160	510x550	230/50	3	-	16,0	700x590x250



BANCHI REFRIGERATI

REFRIGERATED CABINETS



FBR3600TN
+ **FV20033**



FBR2610TN
+ **FV20033**



FBR2600TN
+ **FV15033**

- Struttura interna ed esterna realizzata interamente in acciaio inox AISI304
- Top in granito
- Refrigerazione ventilata con evaporatore ad alette trattato anticorrosione
- Ricircolo aria fredda
- Gruppo incorporato estraibile
- Termostato digitale per il controllo della temperatura e dello sbrinamento
- Resistenza elettrica inserita nella cornice della porta per l'eliminazione della condensa
- Evaporazione automatica dell'acqua di condensa
- Spessore isolamento 60 mm
- Guarnizione magnetica facilmente estraibile
- Interno con angoli arrotondati per facilitare la pulizia
- Chiusura pannello frontale con chiave
- Piedini AISI304 regolabili
- Pannello posteriore in acciaio inox

- *Internal and external structure entirely made of AISI304 stainless steel*
- *Granite worktop*
- *Ventilated refrigeration with anticorrosion treated evaporator*
- *Cold air recirculation*
- *Incorporated refrigeration unit*
- *Digital thermostat for temperature control and defrosting*
- *Electrical heating element around door frame to eliminate condensation*
- *Automatic condensation evaporation*
- *60 mm insulation thickness*
- *Easily removable magnetic gasket*
- *Internal rounded edges for easy cleaning*
- *Front panel with keylock*
- *Adjustable stainless steel AISI304 feet*
- *Back panel in stainless steel*



FBR2100TN



FBR3100TN

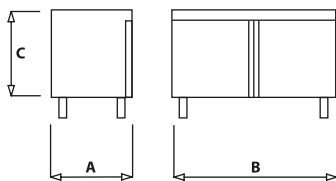

	A	B	C	Alimentazione Power supply	Potenza Power	Temperatura Temperature	Volume vasca Tank diameter	Peso netto Net weight	Dimensioni imballo Packing dimensions
	mm	mm	mm	Volt/Hz	kW	°C	lt.	kg	mm
FBR3600TN	1510	800	1000	230/50	0,30	+2 +8	390	312	2060x830x1020
FBR2610TN	2025	800	1000	230/50	0,30	+2 +8	560	312	2060x830x1020
FBR2600TN	2025	800	1000	230/50	0,35	+2 +8	580	260	1540x830x1020
FBR2100TN	1360	700	860	230/50	0,30	+2 +8	282	113	1560x830x910
FBR3100TN	1795	700	860	230/50	0,30	+2 +8	417	152	2060x830x910



VETRINE REFRIGERATE PER PIZZERIA

REFRIGERATED PIZZA DISPLAY



FV12033

VETRINETTE REFRIGERATE PER PIZZERIA
Struttura interna ed esterna realizzata interamente in acciaio inox AISI 304. Refrigerazione statica. Gruppo incorporato. Termostato digitale per il controllo della temperatura. Spessore isolamento 40mm. Vetri di protezione inclusi. Idonee a contenere bacinelle gastronorm inox o in policarbonato (bacinelle e coperchi esclusi).

REFRIGERATED DISPLAY CASE FOR PIZZERIA
Internal and external structure entirely made of AISI 304 stainless steel. Static refrigeration. Built-in refrigeration unit. Digital temperature control thermostat. Insulation thickness 40mm. Protection glass included. Suited for Gastronorm stainless steel or polycarbonate pans (pans and covers not included).



FV15033



FV18033



FV20033

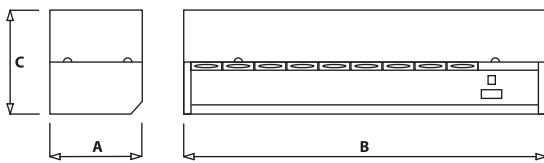

	A	B	C	Alimentazione Power supply	Potenza Power	Temperatura Temperature	Peso Weight	Dimensioni imballo Packing dimensions
	mm	mm	mm	Volt/Hz	kW	°C	Kg.	mm
FV12033 5XGN1/4	335	1200	435	230/50	0,10	+2 +8	50	1270x380x410
FV15033 7XGN1/4	335	1500	435	230/50	0,13	+2 +8	58	1570x380x410
FV18033 9XGN1/4	335	1800	435	230/50	0,15	+2 +8	65	1870x380x410
FV20033 10XGN1/4	335	2000	435	230/50	0,15	+2 +8	70	2070x380x410



FFR650TN C°-2+8



FFR1410TN C°-2+8



FFR650BT C°-18 -22



FFR1410BT C°-18 -22

ARMADI REFRIGERATI VENTILATI GN2/1
Struttura interna ed esterna realizzata interamente in acciaio inox AISI 304. Refrigerazione ventilata con evaporatore ad alette trattato anticorrosione. Gruppo incorporato. Termostato digitale per il controllo della temperatura e dello sbrinamento. Resistenza elettrica inserita nella cornice della porta per l'eliminazione della condensa. Evaporazione automatica dell'acqua di condensa. Porta reversibile. Spessore isolamento 60 mm. Porta con impugnature ergonomiche e guarnizione magnetica facilmente estraibile. Cella con angoli arrotondati per facilitare la pulizia. Luce interna. Chiusura porta con chiave. Piedini in AISI 304 regolabili. Pannelli esterni di fondo e posteriore in acciaio zincato.

VENTILATED REFRIGERATED CABINETS GN2/1
Internal and external structure entirely made of AISI 304 stainless steel. Ventilated refrigeration with anticorrosion treated evaporator. Incorporated refrigeration unit. Digital thermostat for temperature control and for defrosting. Electrical heating element around door frame to eliminate condensation. Automatic condensation evaporation. Reversible door. 60 mm insulation thickness. Doors with ergonomic handles and easily removable magnetic gasket. Internal rounded edges for easy cleaning. Internal light. Door with keylock. Adjustable stainless steel AISI 304 feet. External bottom and back panels in galvanized steel.

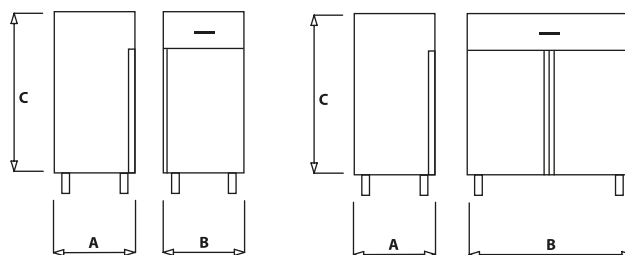

	A	B	C	Alimentazione Power supply	Potenza Motor power	Temperatura Temperature	Dimensioni vasca Tank dimension	Vasche Tank	Capacità Capacity	Peso Weight	Dimensioni imballo Packing dimensions
	mm	mm	mm	Volt/Hz	Watt	°C	mm	Lt.	Lt.	Kg.	mm
FFR650TN	740	830	2010	230/50	300	-2 +8	135x245x105	4,0	650	134	770x860x2180
FFR650BT	740	830	2010	230/50	700	-18 -22	135x245x105x2	4,0+4,0	650	138	770x860x2180
FFR1410TN	1480	830	2010	230/50	650	-2 +8	210x250x110	8,0	1333	198	1510x860x2180
FFR1410BT	1480	830	2010	230/50	950	-18 -22	210x250x110x2	8,0+8,0	1333	208	1510x860x2180

CREDITS



Grafica e Impaginazione **Magazzino.it**

Fotografia **Mauro Foli**

Stampa **Grapho 5 Service**





www.famaindustrie.com

Fama Industrie srl
Via Altobelli, 39 - 47924 Rimini (RN)
Tel +39.0541.388222 - 384509
Fax +39.0541.385662
fama@famaindustrie.com



MADE IN ITALY