



NORDKAPP

tritaggiaccio ice crushers



- Spacca ghiaccio professionale, strumento indispensabile nel bar per la preparazione di drink e frozen, e nel ristorante per l'esposizione di pesce o pietanze fresche.
 - Riduce in scaglie qualsiasi cubetto di ghiaccio prodotto da fabbricatore fino ad una misura di mm 40x40 a -3°C.
 - Previsto di regolazione sullo scarico, permette di gestire la grandezza media delle scaglie
 - Corpo macchina in alluminio estruso, bicchiere in acciaio inox, bocca di lavorazione in ABS alimentare e coltelli ghiaccio in acciaio.
 - Motore ventilato con trasmissione ad ingranaggi, per un servizio prolungato, micro interruttore sul coperchio per la massima sicurezza dell'operatore.
- *Professional ice crusher, an indispensable bar tool for preparing drinks and frozen cocktails and in the restaurant for displaying fish or fresh foods.*
 - *Crushes any ice cubes made with an ice cube machine up to 40x40mm at -3° C.*
 - *Its discharge adjustment lets you regulate the average size of the crushed ice.*
 - *Extruded aluminium body, stainless steel container, food-grade ABS opening and s/steel blades.*
 - *Ventilated motor with gear transmission for prolonged use, micro-switch on the lid for maximum operator safety.*









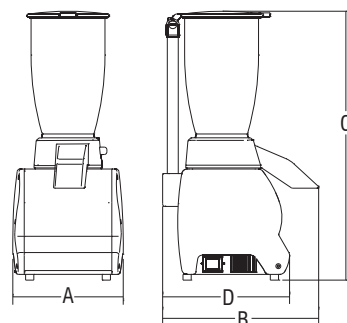





Leva per la regolazione dello spessore del ghiaccio
Adjustable lever ice thickness



Coltelli
Blades



												
	watt	1ph	r.p.m.	lt	lt	mm	mm	mm	mm	kg	mm	kg
Nordkapp	150	1ph	800	3	2	205	285	491	235	5.2	410x280x560	8

