

Wine

enogalax
wine library
miami
dual temp
easy wine
california



ENOGALAX

Un elegante gioco di trasparenze

ENOGALAX è la soluzione più avanzata nel panorama mondiale dell'esposizione e conservazione del vino, in termini di tecnologia, design e flessibilità.

Frutto di uno straordinario investimento progettuale produttivo sviluppato da ENOFRIGO in collaborazione con un designer di fama internazionale, è un sistema moderno che permette soluzioni e composizioni pressoché infinite, dal piccolo modulo singolo alla wine-room da sogno.

ENOGALAX nasce per le nuove modalità dei consumi e d'incontro con l'universo del vino: dal wine-bar di tendenza al grande hotel internazionale, dal ristorante classico ai nuovi luoghi del leisure, dall'enoteca storica ai templi del gusto, dalle nave da crociera, allo yachting e, perché no, alle residenze più esclusive.

Transparent elegance

ENOGALAX is the most advanced solution in the universe of wine bottle displays and storage cabinets, thanks to its technology, design and flexibility.

Born as a result of an extraordinary planning and productive investment made by ENOFRIGO in collaboration with an internationally renowned designer, ENOGALAX is a modern system that allows almost infinite solutions and compositions, from small single modules to the dream wine-room.

ENOGALAX is conceived to meet new consumption needs and different ways of interacting with the wine world: trendy wine-bars and prestigious international hotels, classic restaurants and new places for leisure, historic wine shops and food temples, cruise ships, yachting and exclusive houses.

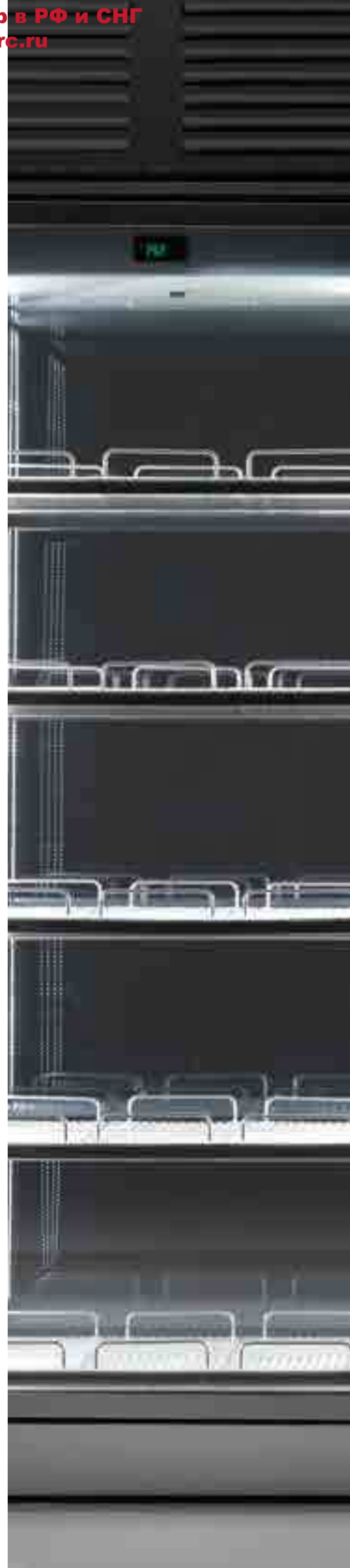



ENOGALAX

Libertà compositiva moltiplicata all'infinito

Ogni modulo viene fornito "nudo" per essere integrato in arredi esistenti o "vestito", con una ampia gamma di finiture di serie o a richiesta per abbinarsi a qualsiasi ambientazione. E se cambia l'arredamento del locale basta cambiare il vestito.

Total freedom of arrangement

Each module is offered either "naked", to be integrated in existing furnishings, or "dressed", with a wide range of serial and custom-made finishes that can suit any ambience. If the space furniture changes, all it needs is changing the dress.

* Disponibile in versione monofacciale
 * Available also in Wall version

** Disponibile in versione bifacciale
 ** Available also in Island version



800
 MONOFACCIALE**
 SINGLE SIDE

1200
 BIFACCIALE*
 DOUBLE SIDE

1600
 MONOFACCIALE**
 SINGLE SIDE



Colori Colour options

Telai porte in alluminio anodizzato grigio.

The unit's door frames are made of silver anodized aluminium.

Grigio Alluminio Satinato
 Brushed Aluminium Grey



Nero Semi-lucido
 Semi-Glossy Black



Bianco Semi-lucido
 Semi-Glossy White





Sistema modulare

Tutti gli elementi del sistema sono dimensionati secondo una modularità che permette di realizzare un numero infinito di configurazioni adatte a ogni tipo di spazio e di esigenza di esposizione e conservazione: mono e bifacciali, con temperature differenziate o unica temperatura, con motore a bordo o remoto.

Modular system

All the system elements are sized according to a modularity criterion so that it is possible to create an infinite number of configurations for any kind of space and displaying/conservation need: they can be mono and bi-facial, have one or differentiated temperatures and have on board or remote engine.



2000
 BIFACCIALE*
 DOUBLE SIDE



2000
 MONOFACCIALE**
 SINGLE SIDE



2400
 BIFACCIALE*
 DOUBLE SIDE

Grigio Cenere
 Grey Ash



OPTION
 Vetro Special - Special Glass



OPTION - Other Colours



ENOGALAX

Un sistema spaziale

ENOGALAX crea lo spazio e favorisce l'attività: per dividere, schermare, creare zone diverse all'interno dello stesso locale o addirittura ambienti autonomi anche di grandi dimensioni, senza bisogno di opere murarie.

A "spatial" system

ENOGALAX creates space and favours operations: it helps dividing and screening areas, creating different zones inside the same room or even large autonomous spaces, without building walls





ENOGALAX





Una cornice esteticamente innovativa

Minimale, di forte spessore, crea un particolare effetto chiaroscurale incorniciando i prodotti esposti. Una elegante maniglia incassata fornisce un'ottima presa ed evita fastidiose sporgenze verso l'utente.

An extremely innovative frame design

Minimalist, with a considerable thickness, it creates a particular light and shade effect highlighting the displayed products. An elegant recessed handle provides an excellent grip and avoids annoying protrusions towards the user.

ENOGALAX

Mono o Bifacciale

Esposizione mono o bi facciale per la massima capacità o la migliore visibilità della bottiglia.

Ogni vetrina può essere apribile da un solo lato con anta a vetri e schienale fisso cieco o a vetri (Optional), oppure con anta apribile da entrambi i lati.

Single or Double face

Single (Wall) or double side (Island) exposure for maximum capacity or better visibility of the bottle.

Each display cabinet can be opened with glass doors either from one side, with a fixed back (blind or glass-topped - Optional), or from both sides.



Ripiani facilmente estraibili per una completa pulizia (anche in lavastoviglie)

Fully removable shelves for easy cleaning (dishwasher compatible)





Il sistema dei ripiani

Il sistema dei ripiani consente una totale flessibilità e libertà espositiva. L'utente può configurare la composizione che preferisce, privilegiando la massima capienza o la visibilità ottimale.

The shelf system

The shelf system permits great flexibility and adapts to different exhibition displays. Users can choose their preferred composition, favouring either capacity or visibility.

I ripiani in policarbonato e acciaio inox sono posizionabili a diverse altezze e reclinabili, è sufficiente spostare le viti con cui sono fissate alla barra centrale.

Shelves made in polycarbonate and stainless steel can be positioned at different heights and they can be reclined.



ENOGALAX

Più spazio al contenuto

La versatilità del sistema di ripiani, facilmente riposizionabili, e la totale assenza all'interno del vano bottiglie di elementi d'ingombro, quali griglie o dispositivi per il raffreddamento, garantiscono la massima capienza favorendo una maggiore funzionalità, praticità e facilità d'accesso ai prodotti.

More space for contents

A versatile system of easily repositioned shelves and the absence of grilles and cooling devices that protrude into the bottle compartment permit full use of available space, maximise functionality and practicality and ensure easy access to contents.

Illuminazione a LED integrata
con colore naturale e Ambra (optional)

Integrated LED lightning:
natural and Amber colour (optional)



Serratura integrata e maniglia incassata a filo
(a destra oppure a sinistra).

Integrated lock and recessed handle
(right or left-handed).





ENOGALAX Neutron

Technical Data

 pag. 120



ENOGALAX NEUTRON

Shelves (UP TO) Code

MODULO SINGOLO - SINGLE MODULE	10	240	GN1
MODULO DOPPIO - DOUBLE MODULE	20	480	GN2
MODULO TRIPLO - TRIPLE MODULE	30	720	GN3
RIPIANO SINGOLO - SINGLE SHELF			GA87430005R
RIPIANO DOPPIO - DOUBLE SHELF			GA87430008R

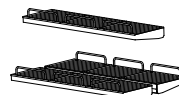

NON SUPERARE 30 Kg
 NOT TO EXCEED 66 lb



GN1

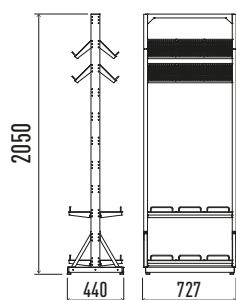

GN2

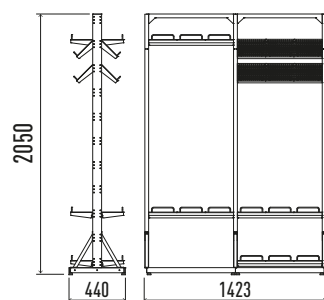

GN3

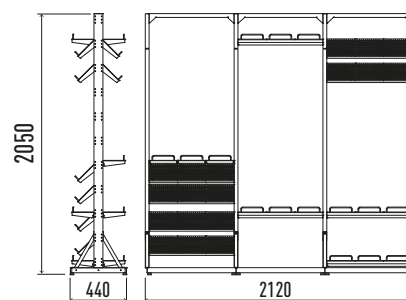

ENOGALAX

Moduli singoli motore a bordo / predisposti per la remotizzazione
 Individual modules with on-board motor / provision for remote motor



T.A. 30°C - U.R. 55%
 CLIMATE CLASS 4



Door Evaporation Shelves Humidity control Capacity (Liters) (UP TO) Code



Remoto senza motore con valvola
 Remote, without motor, valve included

Remoto con motore collegato con valvola
 Remote, with disconnected motor, valve included

Senza Cover
 No Cover

Altri colori
 Other Colours

Cover Vetro
 Glass Cover

H800 Monofacciale - Single side

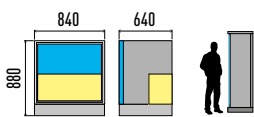

DOOR H800	STATIC	3		181	68	GM1*1S
DOOR H800	FAN ASSISTED	3		181	68	GM1*1V
DOOR H800	FAN ASSISTED	3	•	181	68	GM1*1U

H1200 Monofacciale - Single side

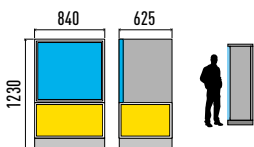

DOOR H800	STATIC	4		228	68	GM2*1S
DOOR H800	FAN ASSISTED	4		228	68	GM2*1V
DOOR H800	FAN ASSISTED	4	•	228	68	GM2*1U

H1600 Monofacciale - Single side

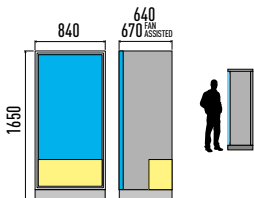

DOOR H1600	STATIC	7		456	167	GM3*1S
DOOR H1600	FAN ASSISTED	7		456	167	GM3*1V
DOOR H1600	FAN ASSISTED	7	•	456	167	GM3*1U

H2000 Monofacciale - Single side

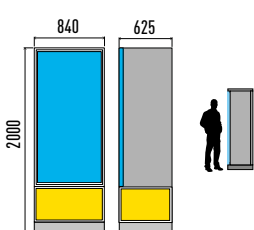

DOOR H1600	STATIC	8		517	192	GM4*1S
DOOR H1600	FAN ASSISTED	8		517	192	GM4*1V
DOOR H1600	FAN ASSISTED	8	•	517	192	GM4*1U

H2000 Monofacciale - Single side

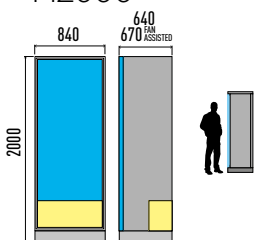

DOOR H2000	STATIC	9		583	215	GM5*1S
DOOR H2000	FAN ASSISTED	9		583	215	GM5*1V
DOOR H2000	FAN ASSISTED	9	•	583	215	GM5*1U

H2400 Monofacciale - Single side

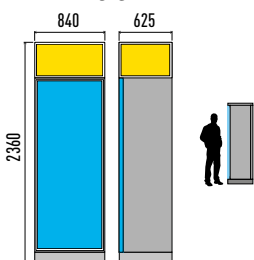

DOOR H2000	STATIC	10		650	240	GM6*1S
DOOR H2000	FAN ASSISTED	10		650	240	GM6*1V
DOOR H2000	FAN ASSISTED	10	•	650	240	GM6*1U

OPTIONAL

Code

CONTROLLO UMIDITA' RELATIVA per il singolo vano - RELATIVE HUMIDITY DIGITAL CONTROL for the single refrigerated compartment	OPT87001	U.R. 50% - 70%
OPZIONE COLORE LAMINATO SPECIALE H800-H1200 - SPECIAL LAMINATED OPTIONAL COLOURS H800-H1200	OPT87002	
OPZIONE COLORE LAMINATO SPECIALE H1600 - SPECIAL LAMINATED OPTIONAL COLOURS H1600	OPT87003	
OPZIONE COLORE LAMINATO SPECIALE H2000-H2400 - SPECIAL LAMINATED OPTIONAL COLOURS H2000-H2400	OPT87004	

Technical Data
 pag. 120



+4°
+18°
T.A. 30°C - U.R. 55%
CLIMATE CLASS 4



Door Evaporation Shelves Humidity control Capacity (Liters) (UP TO) Code

Remoto senza motore con valvola
Remote, no motor, valve included

Remoto con motore scollegato con valvola
Remote, disconnected motor and valve included

Senza Cover
No Cover

Altri colori
Other Colours

Cover Vetro
Glass Cover

Wine

Model	Door	Evaporation	Shelves	Humidity control	Capacity (Liters)	(UP TO)	Code	Remote without motor	Remote with motor	Cover	Other Colours	Glass Cover
H800 Bifacciale - Double side												
	DOOR H800	STATIC	4		228	68	GB1*1S					
	DOOR H800	FAN ASSISTED	4		228	68	GB1*1V					
	DOOR H800	FAN ASSISTED	4	●	228	68	GB1*1U					
H1200 Bifacciale - Double side												
	DOOR H800	STATIC	4		228	68	GB2*1S					
	DOOR H800	FAN ASSISTED	4		228	68	GB2*1V					
	DOOR H800	FAN ASSISTED	4	●	228	68	GB2*1U					
H1600 Bifacciale - Double side												
	DOOR H1600	STATIC	8		517	192	GB3*1S					
	DOOR H1600	FAN ASSISTED	8		517	192	GB3*1V					
	DOOR H1600	FAN ASSISTED	8	●	517	192	GB3*1U					
H2000 Bifacciale - Double side												
	DOOR H1600	STATIC	8		517	192	GB4*1S					
	DOOR H1600	FAN ASSISTED	8		517	192	GB4*1V					
	DOOR H1600	FAN ASSISTED	8	●	517	192	GB4*1U					
H2000 Bifacciale - Double side												
	DOOR H2000	STATIC	10		650	240	GB5*1S					
	DOOR H2000	FAN ASSISTED	10		650	240	GB5*1V					
	DOOR H2000	FAN ASSISTED	10	●	650	240	GB5*1U					
H2400 Bifacciale - Double side												
	DOOR H2000	STATIC	10		650	240	GB6*1S					
	DOOR H2000	FAN ASSISTED	10		650	240	GB6*1V					
	DOOR H2000	FAN ASSISTED	10	●	650	240	GB6*1U					

NOTE: disponibile anche con lato vetrato bloccato, senza serratura - also available with fixed glass side, without lock

* GAS Refrigerante (vedi pag. 7 e pag. 27) - Refrigerating GAS (see page 7 and page 27)

OPTIONAL

Luci LED tonalità ambra - Amber LED lighting

Code

OPT87005

NOT FOR RETROFIT

DIMMER

OPT87006

NOT FOR RETROFIT

RIPIANO SINGOLO - SINGLE SHELF



NON SUPERARE 30 Kg
NOT TO EXCEED 66 lb

GA87430005R

RIPIANO DOPPIO - DOUBLE SHELF



GA87430008R

ENOGALAX

Esempi di composizioni con motore remoto
Examples of configurations with remote motor

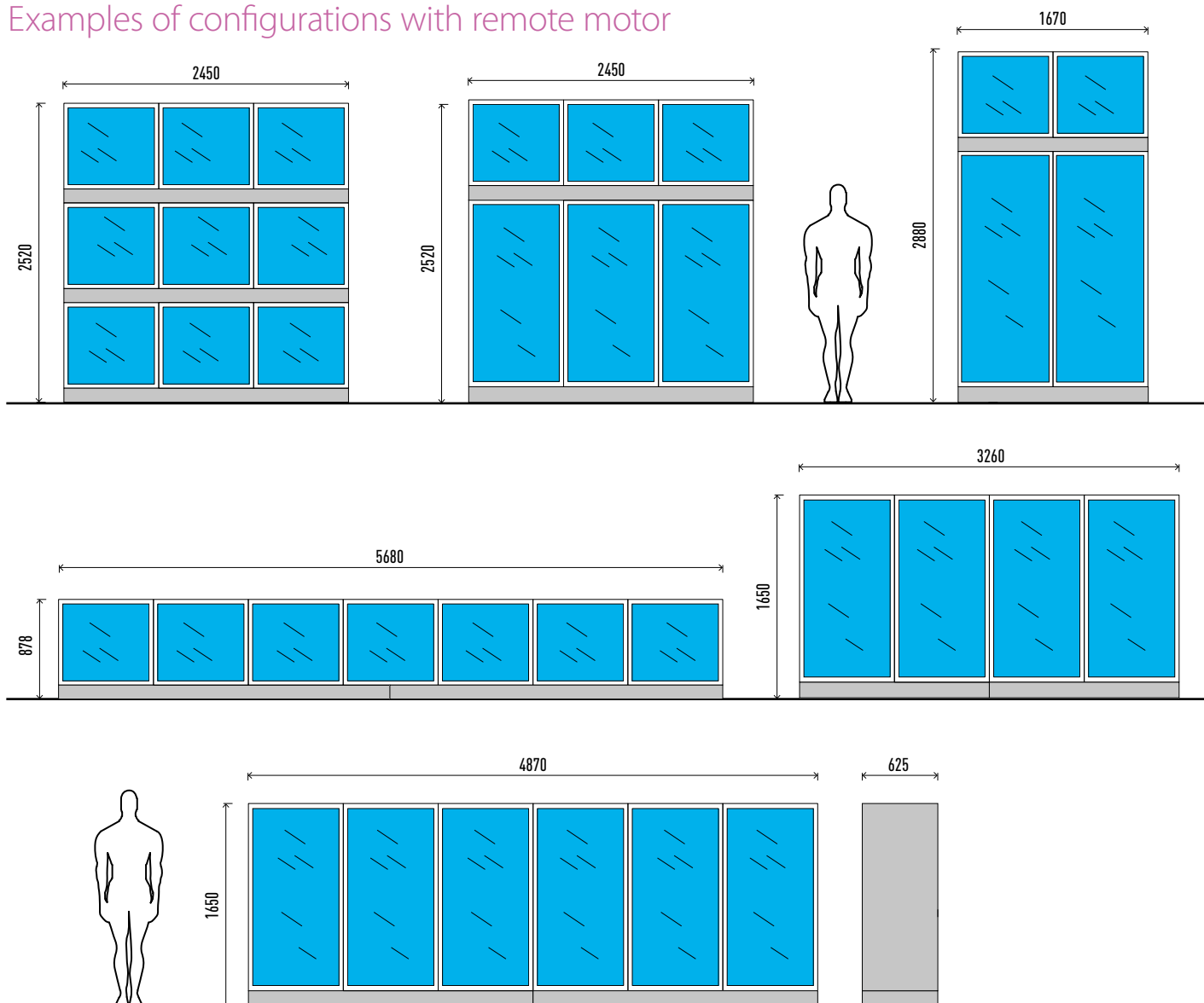

Esempi di composizioni con vano tecnico
Examples of configurations with motor compartment

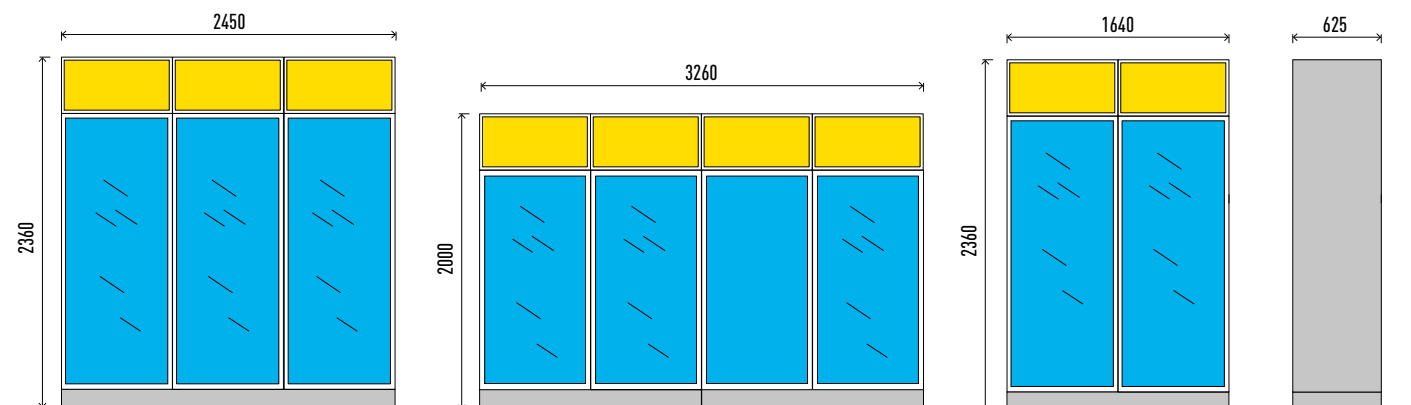

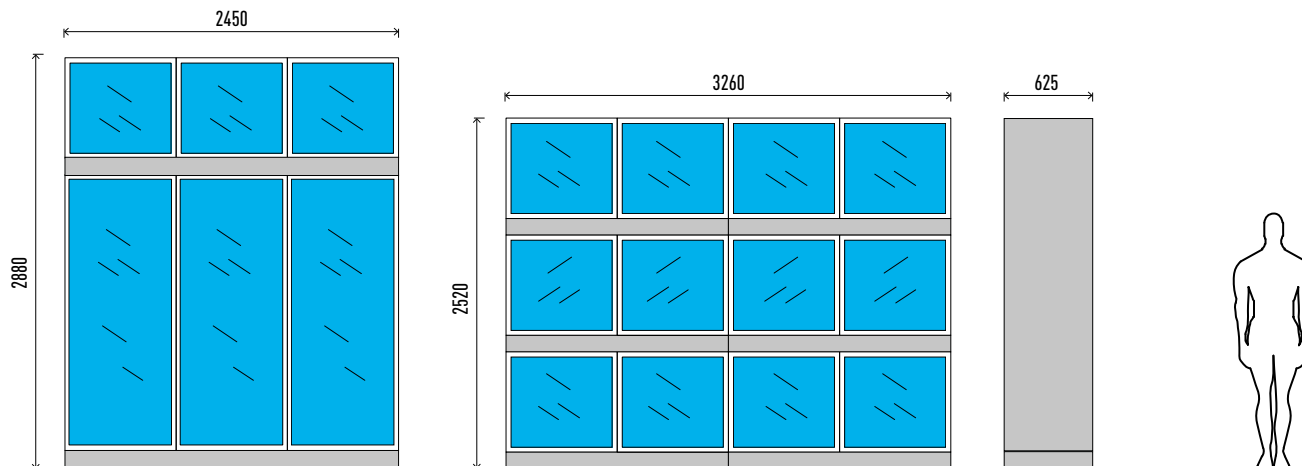

LEGENDA

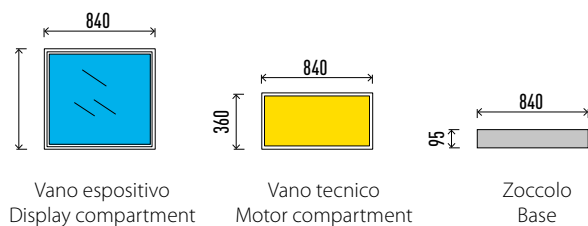

Spessore cover Cover thickness

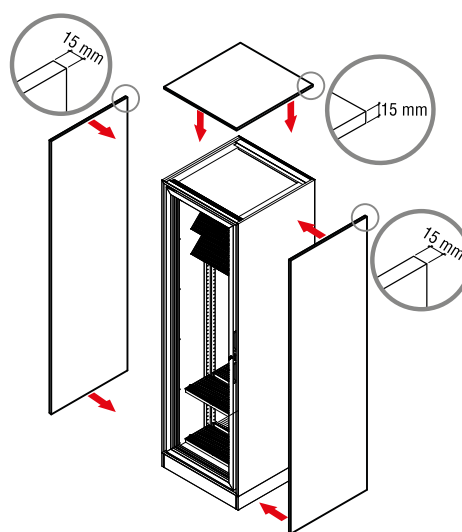

Codice Code

ENOGALAX	M Monofacciale con ripiani interni dritti Wall - Flat Internal Layout	<table border="1"> <tr><td>1</td><td>Vetrina/ Cabinet H.800 Porta/ Door H.800</td></tr> <tr><td>2</td><td>Vetrina/ Cabinet H.1200 Porta/ Door H.800</td></tr> <tr><td>3</td><td>Vetrina/ Cabinet H.1600 Porta/ Door H.1600</td></tr> <tr><td>4</td><td>Vetrina/ Cabinet H.2000 Porta/ Door H.1600</td></tr> <tr><td>5</td><td>Vetrina/ Cabinet H.2000 Porta/ Door H.2000</td></tr> <tr><td>6</td><td>Vetrina/ Cabinet H.2400 Porta/ Door H.2000</td></tr> </table>	1	Vetrina/ Cabinet H.800 Porta/ Door H.800	2	Vetrina/ Cabinet H.1200 Porta/ Door H.800	3	Vetrina/ Cabinet H.1600 Porta/ Door H.1600	4	Vetrina/ Cabinet H.2000 Porta/ Door H.1600	5	Vetrina/ Cabinet H.2000 Porta/ Door H.2000	6	Vetrina/ Cabinet H.2400 Porta/ Door H.2000	<table border="1"> <tr><td>A</td><td>Motore a bordo gas R134a Self Contained gas R134a</td></tr> <tr><td>B</td><td>Motore a bordo gas R404a Self Contained gas R404a</td></tr> <tr><td>C</td><td>Motore a bordo gas R290 condensazione Statica Self Contained gas R290 Static Condensation</td></tr> <tr><td>D</td><td>Motore a bordo gas R290 condensazione Ventilata Self Contained gas R290 Fan Assisted Condensation</td></tr> <tr><td>E</td><td>Motore a bordo gas R600a Self Contained gas R600a</td></tr> <tr><td>N</td><td>Remoto gas R134a Remote gas R134a</td></tr> <tr><td>P</td><td>Remoto gas R404a Remote gas R404a</td></tr> </table>	A	Motore a bordo gas R134a Self Contained gas R134a	B	Motore a bordo gas R404a Self Contained gas R404a	C	Motore a bordo gas R290 condensazione Statica Self Contained gas R290 Static Condensation	D	Motore a bordo gas R290 condensazione Ventilata Self Contained gas R290 Fan Assisted Condensation	E	Motore a bordo gas R600a Self Contained gas R600a	N	Remoto gas R134a Remote gas R134a	P	Remoto gas R404a Remote gas R404a	<table border="1"> <tr><td>1</td><td>Maniglia su lato destro Handle on Right Side</td></tr> <tr><td>2</td><td>Maniglia su lato sinistro Handle on Left Side</td></tr> </table>	1	Maniglia su lato destro Handle on Right Side	2	Maniglia su lato sinistro Handle on Left Side	<table border="1"> <tr><td>S</td><td>Evaporazione statica Static Evaporation</td></tr> <tr><td>V</td><td>Evaporazione ventilata Fan Assisted Evaporation</td></tr> <tr><td>U</td><td>Controllo umidità relativa Relative Humidity Control</td></tr> </table>	S	Evaporazione statica Static Evaporation	V	Evaporazione ventilata Fan Assisted Evaporation	U	Controllo umidità relativa Relative Humidity Control	<table border="1"> <tr><td>Colori laminato Laminate Colors</td></tr> <tr><td>Cover di rivestimento External Cover</td></tr> </table>	Colori laminato Laminate Colors	Cover di rivestimento External Cover
			1	Vetrina/ Cabinet H.800 Porta/ Door H.800																																								
			2	Vetrina/ Cabinet H.1200 Porta/ Door H.800																																								
			3	Vetrina/ Cabinet H.1600 Porta/ Door H.1600																																								
			4	Vetrina/ Cabinet H.2000 Porta/ Door H.1600																																								
			5	Vetrina/ Cabinet H.2000 Porta/ Door H.2000																																								
6	Vetrina/ Cabinet H.2400 Porta/ Door H.2000																																											
A	Motore a bordo gas R134a Self Contained gas R134a																																											
B	Motore a bordo gas R404a Self Contained gas R404a																																											
C	Motore a bordo gas R290 condensazione Statica Self Contained gas R290 Static Condensation																																											
D	Motore a bordo gas R290 condensazione Ventilata Self Contained gas R290 Fan Assisted Condensation																																											
E	Motore a bordo gas R600a Self Contained gas R600a																																											
N	Remoto gas R134a Remote gas R134a																																											
P	Remoto gas R404a Remote gas R404a																																											
1	Maniglia su lato destro Handle on Right Side																																											
2	Maniglia su lato sinistro Handle on Left Side																																											
S	Evaporazione statica Static Evaporation																																											
V	Evaporazione ventilata Fan Assisted Evaporation																																											
U	Controllo umidità relativa Relative Humidity Control																																											
Colori laminato Laminate Colors																																												
Cover di rivestimento External Cover																																												
G	M	2	A	1	V	(Col./Cov.)																																						

e.g. ENOGALAX MONOFACCIALE H1200 DOOR H800 MOT R134 EVAP VENT 4 SHELVES

WINE LIBRARY

Al centro dell'attenzione

La Wine Library è un prodotto modulare per enfatizzare al massimo le bottiglie di vino al centro della sala di ristorazione. L'altezza delle porte a vetro, combinata con un'imponente illuminazione a led e gli interni a specchio daranno alle bottiglie di vino una cornice elegante e preziosa. La scelta di unire più moduli darà al cliente la possibilità di creare delle pareti divisorie all'interno di grandi sale dando allo stesso tempo la continuità visiva del locale grazie alle porte fronte/retro del prodotto. Per chi volesse, invece, inserire la Wine Library presso una parete, prevedendo una sufficiente aerazione, potrà scegliere la soluzione ad una porta con il retro chiuso a specchio creando una parete attrezzata per il vino e non solo. Il vino con la Wine Library sarà al centro dell'attenzione e diventerà un punto di luce all'interno di ogni locale. La porta è realizzata con vetrocamera a bassa emissività di spessore 28 mm. Il vetro è sostenuto da un telaio in alluminio con guarnizione magnetica. La struttura è realizzata con pannello isolante di spessore 50 mm in legno laminato. La refrigerazione è ventilata. La disposizione delle bottiglie nel vano è flessibile: possibilità di inserire tubi in acciaio per esporre le bottiglie orizzontalmente oppure inclinate, piani in acciaio o plexiglass forati per disporre le bottiglie in verticale, eleganti culle trasparenti in plexiglass per sospendere le bottiglie in orizzontale ed infine supporti bottiglie multi-posizione. I diversi possibili formati daranno ad ogni cliente la possibilità di trovare la soluzione migliore alle proprie esigenze. Altezze disponibili da 260 cm o 220 cm. Moduli a due oppure a tre porte, con la possibilità opzionale di gestire l'umidità interna.

A shiny point catching everybody's attention

The Wine Library model is designed to create the most attractive wine bottle display in any room. The height of the doors, combined with outstanding LED lighting and mirrored internal walls, provide an elegant and refined frame for wine bottles. With the Wine Library, bottled wine becomes a beautiful focal point in the room, capturing everyone's attention. The Wine Library can be equipped with a humidity control system. Customers can also combine multiple units to create separating walls in large rooms, while also ensuring visual continuity of the room with the front/rear doors of the product. It is also possible to install the Wine Library on a wall, by simply allowing sufficient ventilation. This one-door version features a mirrored, closed back wall, forming a storage wall for wine and other products. The Wine Library's door is made of 28mm thick, low emission, double-glazing glass, which is embedded in a frame with magnetic gaskets. The body of the unit is made of a 50mm thick insulating panel. The arrangement of bottles in the compartment is entirely adjustable, with steel tubes to display bottles horizontally or oblique, steel or plexiglas perforated shelves for vertical displays, elegant plexiglas moulded supports to hold bottles in a horizontal position or even special multi-position metal supports. All customers can find a solution that best suits their needs with the variety of size options available in the Wine Library. There are two or three door models as well as height options from 260 cm or 220 cm.





WINE LIBRARY



ECO FRIENDLY

Risparmio energetico

Bassi consumi grazie alla illuminazione a led, spessore dei montanti di 5 cm, un sistema di controllo che ottimizza l'utilizzo del sistema refrigerante e alla porta in vetro camera basso emissivo.

Energy efficient

With LED lighting, 50mm thick insulation, a 20mm thick low emissions, double-glazing glass door and a control system which improves the efficiency of the refrigeration equipment, energy consumption is quite low in this unit.



Layout personalizzabile

Possibilità di disporre le bottiglie in verticale, in obliquo o in orizzontale, a seconda delle preferenze. Su ripiani inox (R) o in plexiglass forati (P), su tubi in acciaio (T, A) o su eleganti culle trasparenti in plexiglass (C).

Custom internal layout

Bottles can be displayed in a variety of positions, according to individual needs and tastes: vertically, with stainless steel (R) or plexiglass (P) shelves, on an incline, with stainless steel tubes (A) or horizontally (T), with plexiglass supports (C).



Spazi interni più ampi

Grazie all'innovativo sistema di refrigerazione gli interni sono privi della piastra evaporante. Viene aumentata la capienza di bottiglie e l'interno a specchio crea un effetto di visibilità a 360°.

Internal system

The innovative, ventilated refrigeration system in the Wine Library maintains the correct temperature without using an evaporator and consequently gaining interior space.



Design elegante

Linee pulite, supporti trasparenti per le bottiglie, illuminazione a led lungo le porte, interni a specchio, maniglie in acciaio inox, laminati moderni.

Elegant design

Sleek, clean lines, transparent bottle racks, mirrored internal walls, stainless steel handles, and modern, laminated wood create an elegant and refined frame to showcase wine bottles.



Visibilità

L'esposizione utile estremamente ampia, con i led posizionati lungo il perimetro della porta e gli interni a specchio mettono in risalto al massimo le bottiglie.

Visibility

The Wine Library's wide display area features LED lights along the perimeter of the door as well as mirrored internal walls, creating a striking effect for the ultimate bottle display with a 360° view effect.



Formati modulari

Disponibilità di scelta tra due diverse altezze del modulo, moduli a due oppure a tre porte. Ogni modulo è dotato di un sistema di gestione indipendente della temperatura e dell'umidità (optional) nel singolo vano refrigerato. Porte vetro fronte/retro o retro chiuso con interno in acciaio inox, finitura a specchio.

Modular size options

Two height options and two or three door models are available. Each unit is equipped with a stand-alone temperature and humidity (optional) control kit for the refrigerated compartment. Front/rear doors or a closed back well are also options, along with internal mirrored stainless steel.



Temperature

La refrigerazione ventilata permette di scegliere il set preferito di temperatura interna. Impostazioni da 4°C a 18°C per ciascun modulo.

Temperature

The temperature settings in this unit range from 4°C to 18°C, which can be set easily by the operator for each module.

Display



Humidity Control Display (OPTIONAL)





(optional)

Controllo digitale umidità relativa

Il controllo opzionale dell'umidità permette di mantenere un livello di umidità relativa maggiore del 50% e creare così l'ambiente ideale di conservazione del tappo della bottiglia e dell'etichetta.

Relative humidity digital control

As an option, you can control and maintain the humidity level above 50%, in order to create the perfect storage environment for bottle corks and labels.



(optional)

Sempre aggiornati

Tramite la porta USB del termoregolatore è possibile aggiornare la macchina, effettuare il download della lista allarmi HACCP e configurare i parametri dell'unità.

Always up-to-date

Through the USB port of the controller it is possible to upgrade the machine, download the list of HACCP alarms and configure the parameters of the unit.



Colori

Legno laminato colore nero semi-lucido e grigio alluminio satinato. Telaie porte in alluminio anodizzato grigio oppure nero. Altre colorazioni disponibili come optional. (Telaio porta rimane nero o grigio)

Colour options

The wood laminate body is available in both semi-glossy black and brushed aluminium grey. The unit's door frames are made of anodized aluminium in silver or black. Other colour options are available upon request. (Door frame remains black or silver)

Grigio Alluminio Satinato
Brushed Aluminium Grey



Nero Semi-lucido
Semi-Glossy Black



OPTION - Other Colours



WINE LIBRARY

Technical Data

 pag. 120 - 122

WALL 2P

ISLAND 2P



4V 2P



T.A. 30°C - U.R. 55%
 CLIMATE CLASS 4

WINE LIBRARY 2P



WINE LIBRARY 2P ISLAND H260 P60	420	A1WL12P266/*
WINE LIBRARY 2P ISLAND H220 P60	336	A1WL12P226/*
WINE LIBRARY 2P WALL H260 P60	420	A1WLW2P266/*
WINE LIBRARY 2P WALL H220 P60	336	A1WLW2P226/*
WINE LIBRARY 2P 4V H260 P60	420	A1WL4V2P266/*
WINE LIBRARY 2P 4V H220 P60	336	A1WL4V2P226/*



WINE LIBRARY 3P



WINE LIBRARY 3P ISLAND H260 P60	630	A1WL13P266/*
WINE LIBRARY 3P ISLAND H220 P60	504	A1WL13P226/*
WINE LIBRARY 3P WALL H260 P60	630	A1WLW3P266/*
WINE LIBRARY 3P WALL H220 P60	504	A1WLW3P226/*
WINE LIBRARY 3P 4V H260 P60	630	A1WL4V3P266/*
WINE LIBRARY 3P 4V H220 P60	504	A1WL4V3P226/*

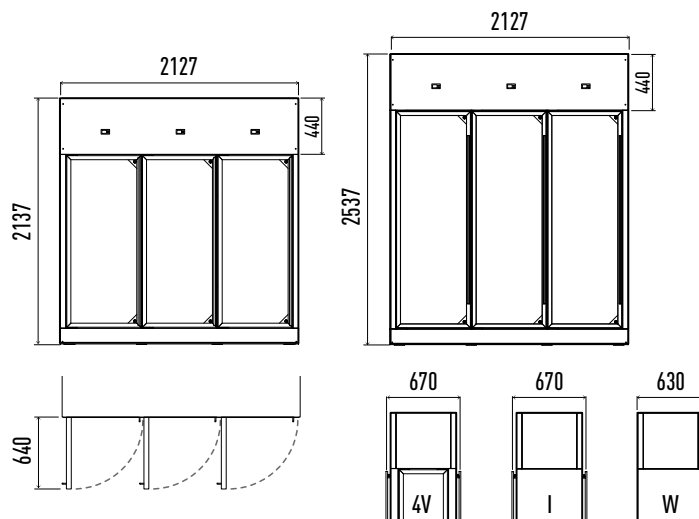
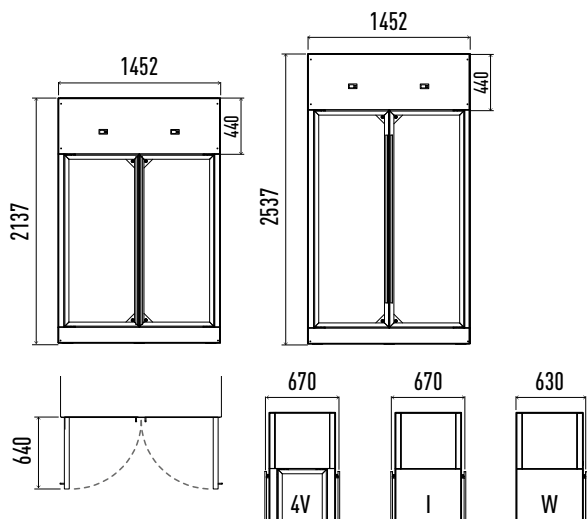

ISLAND 3P H260

4V 3P H220



Wine

OPTIONAL

Unità Remota - Remote unit

<p>Versione (WINE LIBRARY) predisposta per remotizzazione (senza unità) per il singolo vano</p>	<p>Prearranged remotable (WINE LIBRARY) version (without condensing unit) for the single refrigerated compartment</p>	<p>(1P) OPT20001</p>
---	---	----------------------

<p>Versione (WINE LIBRARY) predisposta per remotizzazione (con unità fornita a parte - fino a 8 m orizzontali) per il singolo vano</p>	<p>Prearranged remotable (WINE LIBRARY) version (with condensing unit supplied separately - up to 8 m level) for the single refrigerated compartment</p>	<p>(1P) OPT20002</p>
--	--	----------------------

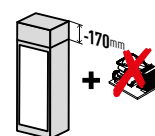

MAGGIORAZIONE su PL
 IN ADDITION TO THE LISTED PRICE



<p>CONTROLLO UMIDITA' RELATIVA (singolo vano)</p>	<p>RELATIVE HUMIDITY DIGITAL CONTROL (each single refrigerated compartment)</p>	<p>OPT20007</p>
---	---	-----------------

<p>OPZIONE COLORE LAMINATO SPECIALE</p>	<p>SPECIAL LAMINATED OPTIONAL COLOURS</p>	<p>2P OPT20009</p>
---	---	--------------------

<p>OPZIONE COLORE LAMINATO SPECIALE</p>	<p>SPECIAL LAMINATED OPTIONAL COLOURS</p>	<p>3P OPT20010</p>
---	---	--------------------

<p>LUCI LED TONALITA' CALDA (3000-3500° K)</p>	<p>Warm white LED lighting (3000-3500° K)</p>	<p>2P OPT20013</p>	<p>NOT FOR RETROFIT</p>
--	---	--------------------	-------------------------

<p>LUCI LED TONALITA' CALDA (3000-3500° K)</p>	<p>Warm white LED lighting (3000-3500° K)</p>	<p>3P OPT20014</p>	<p>NOT FOR RETROFIT</p>
--	---	--------------------	-------------------------

<p>LUCI LED TONALITA' FREDDA (5500-6500° K)</p>	<p>Cool white LED lighting (5500-6500° K)</p>	<p>2P OPT20016</p>	<p>NOT FOR RETROFIT</p>
---	---	--------------------	-------------------------

<p>LUCI LED TONALITA' FREDDA (5500-6500° K)</p>	<p>Cool white LED lighting (5500-6500° K)</p>	<p>3P OPT20017</p>	<p>NOT FOR RETROFIT</p>
---	---	--------------------	-------------------------

<p>DIMMER</p>	<p>2P</p>
---------------	-----------

<p>DIMMER</p>	<p>3P</p>
---------------	-----------

WINE LIBRARY

LAYOUT INTERNO - CUSTOM INTERNAL LAYOUT

 BORDEAUX
 Capacità dei singoli ripiani
 Single shelf capacity

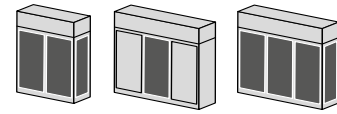
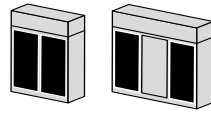

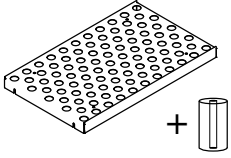
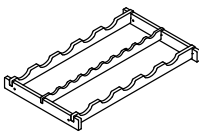
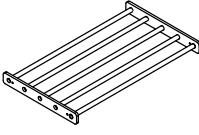
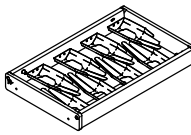
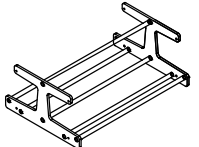
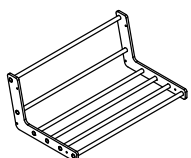
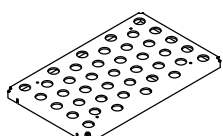
<p>R</p>  M020270001 X 4 Solo se installato sul fondo (vedi manuale di installazione) Only if installed on the bottom (see installation manual)	<p>fino a/ up to 42</p>	<p>M220430006</p>	<p>M220430008</p>
<p>C</p> 	<p>fino a/ up to 10</p>	<p>GK20080010</p>	<p>GK20080009</p>
<p>T</p> 	<p>fino a/ up to 8</p>	<p>GK20330002</p>	<p>GK20330004</p>
<p>M</p> 	<p>fino a/ up to 8</p>	<p>GK20080008</p>	<p>GK20080007</p>
<p>K</p> 	<p>fino a/ up to 14</p>	<p>GK20330006</p>	<p>GK20330005</p>
<p>A</p> 	<p>fino a/ up to 28</p>	<p>GK20330009</p>	<p>GK20330010</p>
<p>P</p> 	<p>non superare 20 kg not to exceed 44 lb</p>	<p>M020430003</p>	<p>M020430001</p>

- Per una logistica ottimale, il prodotto (H260) è fornito in due colli separati.
- For optimum logistics, the product (H260) is supplied in two separate packages.

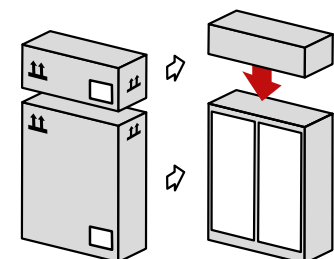

ESEMPI - EXAMPLES

Ripiani in acciaio
Stainless Steel Shelves



H 220
fino a/up to 168*

H 260
fino a/up to 210*



Supporti orizzontali in Plexiglass
Plexiglass Horiz. Supports



H 220
fino a/up to 80*

H 260
fino a/up to 100*



Ripiani in acciaio +
Supporti orizzontali in Plexiglass
Stainless Steel Shelves +
Plexiglass Horiz. Supports



H 220
fino a/up to 124*

H 260
fino a/up to 166*



Tubi in acciaio (T) + Ripiani in acciaio +
Supporti orizzontali in Plexiglass
S. Steel Tubes (T) + S. Steel Shelves (R)
+ Plexi Horizontal Supports (C)

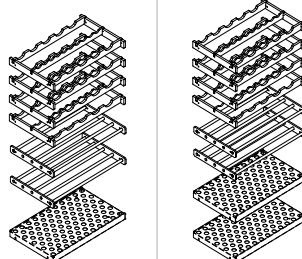

H 220
fino a/up to 98*

H 260
fino a/up to 140*



Tubi in acciaio inclinati
Stainless Steel Sloping Tubes



H 220
fino a/up to 112*

H 260
fino a/up to 140*



Ripiani in Plexiglass
Plexiglass Shelves

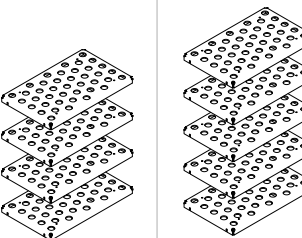

H 220
up to 20 kg (44 lb)
per ripiano/shelf*

H 260
up to 20 kg (44 lb)
per ripiano/shelf*



MIAMI

Un nuovo concetto di esposizione

La priorità viene data all'illuminazione per enfatizzare al massimo le bottiglie di vino contenute al suo interno. I led inseriti frontalmente lungo la cornice della porta e gli interni laminati creano un effetto di profondità e dei giochi di luce che mettono in primo piano le bottiglie di vino.

Innovates the concept of wine cabinets

With improved lighting, the Miami unit offers the ultimate wine bottle display. LED lights are embedded all along the front door frame and the internal finishing create depth and pleasant lighting effects, while enhancing the visibility of wine bottles.



Visibilità

I led posizionati lungo il perimetro della porta e gli interni laminati mettono in risalto al massimo le bottiglie.



ECO FRIENDLY

Risparmio energetico

Fino a – 50% nei consumi rispetto alle tradizionali cantinette per vino grazie alla illuminazione a led, vetro basso emissivo ed un isolamento di 6 cm.



Rumorosità

Il sistema di refrigerazione con condensazione statica è concepito per ridurre al minimo la rumorosità dell'impianto refrigerante.

Visibility

LED lighting along perimeter of the door, combined with the finishing of the internal walls, ensure the ultimate bottle display.

Energy efficiency

Up to 50% less energy consumption in comparison to traditional wine cabinets due to the LED lighting, 60mm thick insulation and the low emission double glazing glass door.

Noise

The static condensation system is designed to provide maximum noise reduction of the refrigeration equipment.



Interni più spaziosi

Grazie all'innovativo sistema di refrigerazione gli interni sono puliti senza la presenza della piastra evaporante. Viene aumentata la capienza di bottiglie e l'interno laminato crea un effetto di visibilità a 360°.



Layout personalizzabile

Possibilità di disporre le bottiglie in verticale, in obliquo o in orizzontale, a seconda delle preferenze. Su ripiani inox forati (SH), su tubi in acciaio (T) o su eleganti cassetti estraibili in legno (DR).



Temperature

La versione con refrigerazione statica permette di ottenere nella stessa unità quattro differenti temperature. Così si possono esporre alla giusta temperatura sia i vini rossi che i bianchi. La versione con refrigerazione ventilata permette di scegliere il set preferito di temperatura uniforme interna. Impostazioni da 4°C a 18°C.

Clean interior

The innovative static refrigeration system ensures the right temperature without the need for an evaporator. The bottle capacity is increased and the finishing of the internal walls provide a 360° view effect.

Custom internal layout

Bottles can be displayed vertically (stainless steel shelves: SH), on an incline (stainless steel tubes: T) or horizontally (pull-out wood drawers: DR), according to individual preferences.

Temperature

The static refrigeration operating mode provides four different temperature zones in one unit. Both red and white wines can be maintained at the most suitable temperature. The fan assisted refrigeration optional version, allows to choose the favourite internal uniform temperature set. The temperature can be set anywhere from 4°C to 18°C.



Colori

Legno laminato colore nero o bianco semi-lucido e grigio alluminio satinato. Telai porte in alluminio anodizzato grigio, nero o bianco.

Altre colorazioni disponibili come optional.
(Telaio porta rimane nero, grigio o bianco)

Colour options

The wood laminate body is available in both semi-glossy black and brushed aluminium grey.

The unit's door frames are made of anodized aluminium in silver or black. Other colour options are available upon request. (Door frame remains black, silver or white)

Grigio Alluminio Satinato
Brushed Aluminium Grey

Nero Semi-lucido
Semi-Glossy Black

Bianco Semi-lucido
Semi-Glossy White

OPTION - Other Colours

873

421

410



MIAMI

MIAMI MEDIUM

MIAMI

MIAMI MINI



MIAMI MINI

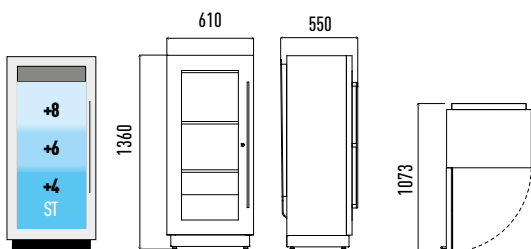

T



DR



SH(R)



MIAMI MEDIUM

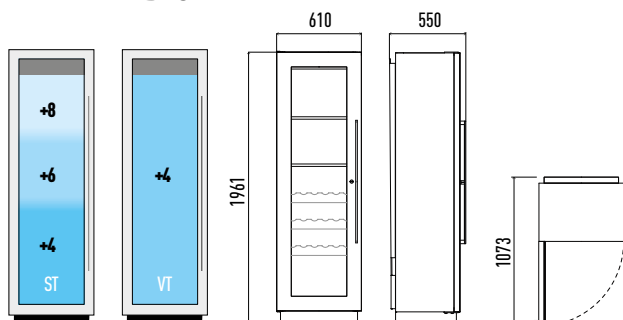

MIAMI

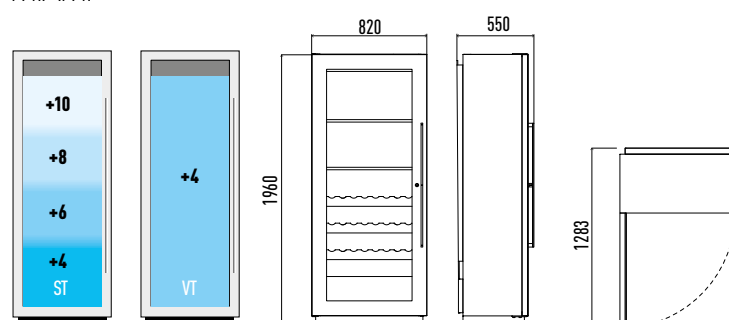

MIAMI B&R

Technical Data

 pag. 122



fino a 1 up to



MIAMI MINI

	MIAMI MINI RF T	A1MIAMIMINI/*	48
	MIAMI MINI RF 6 DR	A1MIAMIMINIDR/*	36
	MIAMI MINI RF R	A1MIAMIMINISH/*	60

MIAMI MEDIUM

	MIAMI MEDIUM RF T	A1MIAMIMED/*	84
	MIAMI MEDIUM RF 12 DR	A1MIAMIMEDDR/*	72
	MIAMI MEDIUM RF T + 3 DR	A1MIAMIMEDMIX/*	66
	MIAMI MEDIUM RF R	A1MIAMIMEDSH/*	108
	MIAMI MEDIUM VT RF T	A1MIAMIMEDVT/*	84
	MIAMI MEDIUM VT RF 12 DR	A1MIAMIMEDDRV/*	72
	MIAMI MEDIUM VT RF T + 3 DR	A1MIAMIMEDMIXVT/*	66
	MIAMI MEDIUM VT RF R	A1MIAMIMEDSHVT/*	108

MIAMI

	MIAMI RF T	A1MIAMI/*	126
	MIAMI RF 12 DR	A1MIAMIDR/*	96
	MIAMI RF T + 3 DR	A1MIAMIMIX/*	96
	MIAMI RF R	A1MIAMISH/*	162
	MIAMI VT RF T	A1MIAMIVT/*	126
	MIAMI VT RF 12 DR	A1MIAMIDRV/*	96
	MIAMI VT RF T + 3 DR	A1MIAMIMIXVT/*	96
	MIAMI VT RF R	A1MIAMISHVT/*	162

MIAMI B&R

	MIAMI B&R RF T	A1MIAMIBR/*	84+84
	MIAMI B&R RF 12 + 12 DR	A1MIAMIBRDR/*	72+72
	MIAMI B&R RF T + 3 DR	A1MIAMIBRMIX/*	66+66
	MIAMI B&R RF R	A1MIAMIBRSH/*	108+108
	MIAMI B&R VT RF T	A1MIAMIBRV/*	84+84
	MIAMI B&R VT RF 12 + 12 DR	A1MIAMIBRDRV/*	72+72
	MIAMI B&R VT RF T + 3 DR	A1MIAMIBRMIXVT/*	66+66
	MIAMI B&R VT RF R	A1MIAMIBRSHVT/*	108+108

OPTIONAL

WL0002

Opzione colore laminati (Telaio porta rimane nero, grigio o bianco)
 Laminated wood optional colours (Door frame remains black, silver or white)

OPT36001

Versione predisposta per remotizzazione (senza unità)
 Prearranged remountable version (without condensing unit)

OPT36002

Luci LED tonalità calda (3000-3500°K)
 Warm white LED lighting (3000-3500°K)

OPT36003

Luci LED tonalità fredda (5500-6500°K)
 Cool white LED lighting (5500-6500°K)

OPT36004 Dimmer

MIAMI B&R

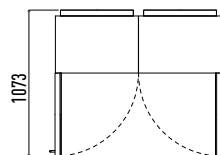
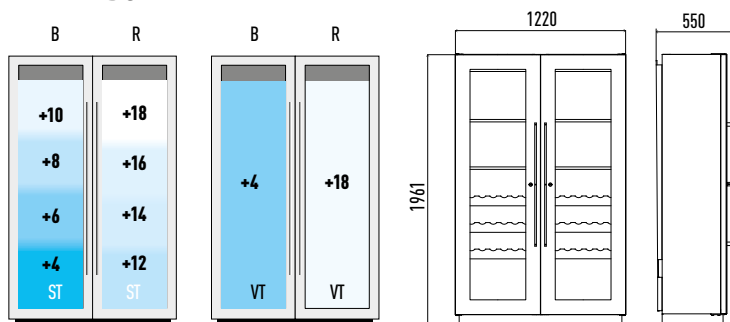

T.A. 30°C - U.R. 55%
 CLIMATE CLASS 4

DUAL TEMP

Dual Temp è un espositore per bottiglie con due vani indipendenti a due diverse temperature, per stoccare e servire i vini bianchi ed i vini rossi alla temperatura ideale. Refrigerazione ventilata con la possibilità di impostare il set preferito di temperatura interna per entrambi i vani. Impostazioni da 5° a 18° C. Vetrocamera fumè. Illuminazione a LED. Tredici ripiani portabottiglie scorrevoli con frontale in betulla.

Il sistema di refrigerazione con condensazione statica è concepito per ridurre al minimo la rumorosità dell'impianto refrigerante.

Colori

Legno laminato colore nero semi-lucido (421) e grigio alluminio satinato (873). Altri colori come optional.

The Dual Temp wine cabinet has two different temperature zones in two independent compartments, for storing and serving white and red wines at the perfect temperature. Fan-assisted refrigeration allows to choose the favourite internal temperature set for both compartments. Total Temperature Range: 5°-18° C. Double-glazing smoked glass door. LED lighting. Thirteen birch wood-trimmed sliding wine racks.

The static condensation system is designed for maximum noise reduction of the refrigeration equipment.

Colour options

The wood laminate body is available in both semi-glossy black (421) and brushed aluminium grey (873). Other colour options are available upon request.

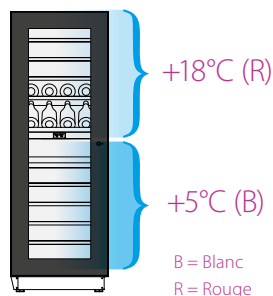

T.A. 30°C - U.R. 55%
 CLIMATE CLASS 4



DUAL TEMPERATURE A1DUALTEMP/*

55(R)
 65(B)

ripiani scorrevoli
 sliding racks

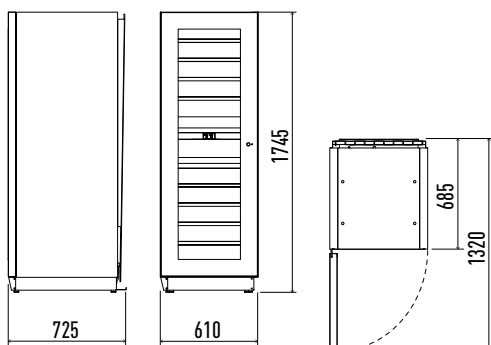

Grigio Alluminio Satinato
 Brushed Aluminium Grey

Nero Semi-lucido
 Semi-Glossy Black

OPTION - Other Colours

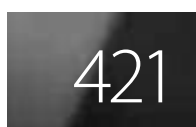
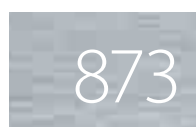

EASY WINE

Wine



Le cantinette Enofrigo si caratterizzano per originalità del design, compattezza e silenziosità. Studiate per l'esposizione e vendita del vino bianco – brut - rosato in bottiglia, EASY WINE costituiscono la miglior soluzione per il servizio del vino alla temperatura ideale.

La struttura è realizzata in legno con piedini regolabili.

La porta è costituita da cornice in legno massiccio e vetrocamera isolante a bassa emissività.

Refrigerazione statica con evaporatore "roll bond" in piastra di alluminio. Comandi digitali dotati di termometro-termostato per la corretta impostazione e lettura della temperatura in camera.

The Enofrigo wine cabinets stand out for original design, compactness and quietness.





Designed for the display and sale of bottled white wine, brut and rosé, thus offering the best possible solution for the serving of wine at its most suitable temperature.

The framework is in walnut coloured wood. The door consists of a frame in solid wood and low emissivity insulating double glazing.

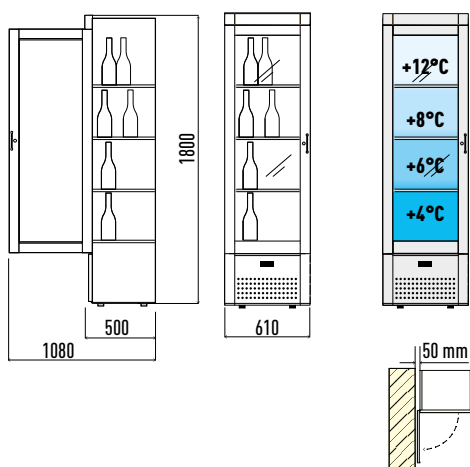
Static refrigeration with "roll bond" evaporator. The digital commands are complete with thermometer /thermostat for the correct setting and reading of the temperature within the chamber.

T.A. 25°C - U.R. 60%



	°C	litri	fino a / up to
 EASY WINE / S	+ 4 / + 12	112	A1EASYWINE/S
 EASY WINE / 873	+ 4 / + 12	112	A1EASYWINE/873
 EASY WINE / SVT	+5	112	A1EASYWINEVT/S
 EASY WINE / 873 VT	+ 5	112	A1EASYWINEVT/873

OPTIONAL

V10001 Colori RAL / RAL Colors

Noce
Walnut

Grigio Alluminio Satinato
Brushed Aluminium Grey

OPTION - Other Colours

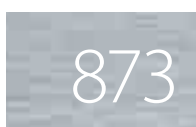

CALIFORNIA

Tradizione e ricerca

Espressione della tradizione ed allo stesso tempo della ricerca volta al miglioramento continuo dei prodotti, la CALIFORNIA LINE si caratterizza per un bassissimo livello di rumorosità consentendo un'accoglienza più confortevole della clientela nella sala ristorante.

Studiati e realizzati per l'esposizione e la vendita del vino rosso - rosato - bianco - brut in bottiglia, i modelli in gamma costituiscono la miglior soluzione per il servizio del vino alla temperatura ideale. Refrigerazione con evaporatore "roll bond" in piastra di alluminio. I modelli ventilati sono dotati di ventilatore interno per impostare un'unica temperatura in camera. Comandi digitali dotati di termometro - termostato per la corretta impostazione e lettura della temperatura in camera. Base con piedini regolabili.



Struttura robusta

Struttura con pannelli isolanti e legno laminato all'esterno. Porta con cornice in legno massiccio e vetrocamera basso-emissivo.

Strong structure

The structure of the California Silent Line is complete with insulated laminated panels, a solid wood door frame with glass bay, door lock and internal lighting.

Noce
Walnut



Rovere Chiaro
Pale Oak



OPTION - Other Colours



Tradition and research

The California Line represents our research and goal to continuously improve our products. This range stands out for its extremely low sound intensity, therefore creating more comfortable surroundings for restaurant clientele.

The models within this range, which have been designed for the display and sale of red wine, rosé, white wine and brut, offer the best possible solution for serving wine at its ideal temperature.

The refrigeration includes an aluminium plate "roll bond" evaporator. The ventilated models are complete with an internal fan for setting a single temperature within the chamber.

Digital controls, complete with a thermometer/thermostat, maintain the correct setting and reading of the chamber temperature.

The base features adjustable support legs.



Temperature

Le versioni con refrigerazione statica permettono di ottenere nella stessa unità quattro differenti temperature, così da poter esporre alla giusta temperatura sia i vini rossi che quelli bianchi.

Le versioni con refrigerazione ventilata (VT) permettono di scegliere il set preferito di temperatura uniforme interna.

Temperature

The static refrigeration product's versions provide four different temperature zones in one unit. Both red and white wines can be maintained at the most suitable temperature.

The fan assisted refrigeration versions (VT), allows to choose the favourite internal uniform temperature set.



Layout personalizzabile

Possibilità di disporre le bottiglie in verticale, in obliquo o in orizzontale, a seconda delle preferenze.

Custom internal layout

Bottles can be placed on an incline with metal tubes, vertically with tempered glass shelves or horizontally with a bottle rack, according to individual preferences.



Silenziosità

Livello di rumorosità: 41,4 dB(A).

Noise

Noise level: 41.4 dB(A).



CALIFORNIA

Technical Data

 pag. 124

CALIFORNIA SLIM







CALIFORNIA



- Struttura con pannelli isolanti, laminato all'esterno.
- Porta con cornice in legno massiccio e vetrocamera.
- Raffreddamento statico con controllo termostatico, n° 4 livelli di appoggio a temperature differenziate (No VT).
- Illuminazione a LED e serratura alla porta.
- Livello di rumorosità: 41,4 dB(A).
- Colori disponibili: noce, rovere chiaro.

- Structure with insulated laminated panels.
- Solid wood door frame with glass bay.
- Static refrigeration digitally controlled, bottle storage on 4 levels with different temperatures (No VT).
- Door lock and LED internal lighting.
- Noise level: 41,4 dB(A).
- Available colours: walnut, pale oak.

T.A. 25°C - U.R. 60%

	°C	fino a / up to	
 CALIFORNIA SLIM	+ 4 / + 12	72	A1CRCAVSLIMSIL
 CALIFORNIA SLIM VT	+ 5	72	A1CRCAVSLIMVTSIL
 CALIFORNIA SILENT	+ 4 / + 12	120	A1CRCAVSIL
 CALIFORNIA SILENT VT	+ 5	120	A1CRCAVENSIL
 SUPER CALIFORNIA	+4/+12 (B) +14/+20 (R)	120+36	A1CRCAVSSIL
 CALIFORNIA B&R	+3/+9(B) +14/+20(R)	72+72	A1CRCAVSIL/BR
 CALIFORNIA R&R	+14/+20(R) +14/+20(R)	72+72	A1CRCAVSIL/RR

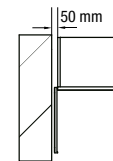

B = Blanc
 R = Rouge



CALIFORNIA SLIM

CALIFORNIA

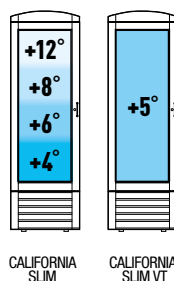
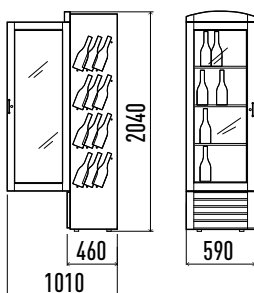

CALIFORNIA SLIM CALIFORNIA SLIM VT

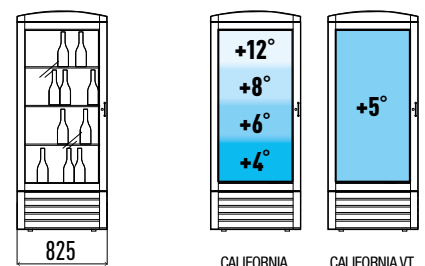

CALIFORNIA CALIFORNIA VT

SUPER CALIFORNIA

CALIFORNIA B&R



Wine

OPTIONAL

2	Alveare in legno	Horizontal bottle rack	ACALVCL/B	CALIFORNIA
2	Alveare in legno	Horizontal bottle rack	GA4300Q010	CALIFORNIA SLIM - CALIFORNIA B&B / R&R
1	Griglia cromata	Chromium-plated rack	M01443Q010	CALIFORNIA
1	Griglia cromata	Chromium-plated rack	M05843Q010	CALIFORNIA SLIM - CALIFORNIA B&B / R&R
1	Ripiano in cristallo temperato	Tempered glass shelf	ACPVCL75535	CALIFORNIA
1	Ripiano in cristallo temperato (solo vini rossi)	Tempered glass shelf (red wines only)	AC15443431	SUPERCALIFORNIA
1	Ripiano in cristallo temperato	Tempered glass shelf	AC43445329	CALIFORNIA B&R / R&R
1	Ripiano in cristallo temperato	Tempered glass shelf	AC58440010	CALIFORNIA SLIM
	Colori RAL	RAL colours	V10001	

SUPER CALIFORNIA

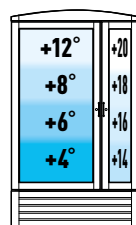
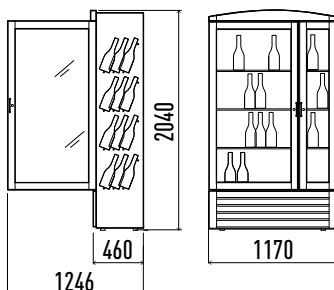

CALIFORNIA B&R

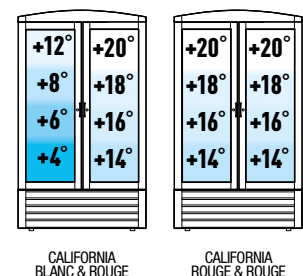
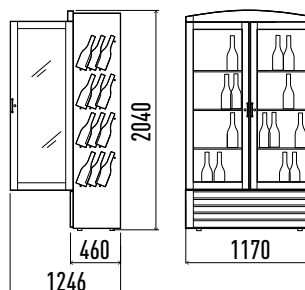

CALIFORNIA
BLANC & ROUGE

CALIFORNIA
ROUGE & ROUGE



www.enofrigo.it

ENOFRIGO S.p.A.
I - 35010 BORGORICCO (PD)
Via dell'Industria, 9/a
Tel. +39 049 5798041
Fax +39 049 5798806
info@enofrigo.com
www.enofrigo.com

INFORMAZIONI COMMERCIALI
SALES INFORMATION
vendite.enofrigo@enofrigo.com
Tel. +39 049 5798041

