



Enigma Shot Master

User Manual

DOC 5700109748 - 01 - 09/2021

E'2ct/Classic

E'choco

E'4m/Classic

Shotmaster m-pro/ST



Document

Original English Enigma User Manual

Version: 01 - 09/2021

Type/Order number:

[See Article number on page 23.](#)



5700109748

Version	Soft	Date	Modification
00	3.0x	20.11.20	First edition
01	3.1x	01.09.21	Second edition



Manufacturer

Eversys S.A. (Eversys AG., Eversys Ltd.)

Ecoparc de Daval A 2

CH-3960 Sierre

Switzerland



The instructions contained in this User Manual must be adhered to in particular the safety instructions. This will help to avoid personal injury and material damage. Ensure that all «Persons» have access to the User Manual.



Thank you for purchasing the Enigma super-automatic coffee machine.

The User Manual will help you to discover all the functions offered by your Enigma and enjoy your products to the full.

If you require further information or have any other questions on the machine, contact your local service organisation or our support team.

Enjoy using your Enigma.

Copyright ©

The reproduction, even partially, of this document is forbidden. No part may be copied in any form, and it may not be used, edited nor transmitted by any electronic means (photocopy, photography, magnetic supports or other recording processes), without the written authorisation of Eversys S.A. All rights and particularly reproduction, translation, edition, distribution and also industrial property and recording are reserved.

Table of Contents

1	For Your Safety	9
1.1	Intended use	9
1.2	Introduction.....	10
1.2.1	Importance of the safety instructions.....	10
1.2.2	Disregarding the safety rules	10
1.3	Directives	10
1.4	General safety instructions	11
1.5	Information for disposal	14
1.6	Decommissioning and disposal	14
1.6.1	Packaging material	14
1.6.2	Removal of equipment	14
1.7	Special safety instructions and signs	15
1.7.1	Signs	15
1.8	Packaging signs.....	16



2	Description	17
2.1	Identification	17
2.1.1	Enigma Key features	18
2.1.2	Shotmaster Key features	18
2.1.3	Enigma Classic range (visuals)	18
2.2	Overview	19
2.2.1	Front view	19
2.2.2	Drip tray open	20
2.2.3	Touch screen	21
2.2.4	Top view (bean hopper)	22
2.3	Technical data	23
2.3.1	E'2ct datasheet	24
2.3.2	E'2s, E'2m datasheet	25
2.3.3	E'4s, E'4m datasheet	26
2.3.4	E'4s x-wide, E'4m x-wide datasheet	27
2.3.5	E'6s, E'6m datasheet	28
2.3.6	E'2ct/ST datasheet	29
2.3.7	E'2s/ST, E'2m/ST datasheet	30
2.3.8	E'4s/ST, E'4m/ST datasheet	31
2.3.9	E'4s x-wide/ST, E'4m x-wide/ST datasheet	32
2.3.10	E'6s/ST, E'6m/ST datasheet	33
2.3.11	Shotmaster ct/Classic	34
2.3.12	Shotmaster s/m/Classic	35
2.3.13	Shotmaster ct/ST	36
2.3.14	Shotmaster s/m/ST	37
2.3.15	Shotmaster s-pro/m-pro/ST	38
2.3.16	Rating plate	39
2.3.17	Machine type correspondence table	40
2.4	e'Connect (Telemetry)	41
2.5	Process flow	42
2.6	Automated cleaning Process flow	43
3	Software	45
3.1	Using the touch screen	45
3.2	Main screen	46
3.2.1	Header strip	47
3.2.2	Top layer	47
3.2.3	Footer strip	47
3.3	Product buttons (default)	48
3.4	Grinder button	49
3.5	Specific settings	49



4	Commissioning	51
4.1	Initial commissioning	51
4.2	Requirements prior to initial commissioning	52
5	Operation	53
5.1	Daily setup guidelines.....	53
5.2	Switch on	54
5.2.1	Standby (wake up).....	54
5.3	Rinse	55
5.3.1	Pre-heat rinse	55
5.3.2	Auto-rinse	55
5.4	Fill the coffee bean hoppers	56
5.5	Cups heating surface	56
5.6	Make a drink	57
5.6.1	Adjust the coffee outlet height	57
5.6.2	Coffee product	57
5.6.3	Hot water product	57
5.6.4	Steam product	58
5.6.5	Steam purge button.....	59
5.6.6	Powder coffee product (decaf.) (optional)	60
5.7	Product stop	61
5.8	Empty grounds drawer.....	62
5.9	Switch off.....	63
5.10	End of the day guidelines	63
5.11	Emergency stop	64
6	Settings Menu	65
6.1	Login menu.....	66
6.2	Use of the software menu (Manager)	67
6.3	Statistic/History.....	68
6.3.1	Product Counter	68
6.4	Products & Keys (Manager login)	69
6.5	Display	70
6.5.1	Import Screen.....	71
6.5.2	Import Language	71
6.6	Beans & Grinder	72
6.6.1	Adjustment tips.....	72
6.7	Clean/Standby	73
6.8	Password	73
6.9	Logout (service engineer).....	74

7	Care	75
7.1	Cleaning and maintenance operations	76
7.1.1	Cleaning	76
7.1.2	Maintenance	77
7.2	Periodic cleaning	78
7.2.1	Cleaning plan	78
7.2.2	Cleaning table	79
7.3	Cleaning procedures	80
7.3.1	Automatic system cleaning procedure (with milk)	80
7.3.2	Coffee/milk outlet V2 (metal)	85
7.3.3	Bean hoppers (and decaffeinated powder chute)	86
7.3.4	Housing	87
7.3.5	Display (touch screen) cleaning	87
7.3.6	Drip tray	88
7.3.7	Refill and visual check of the cleaning balls dispenser	89
7.3.8	How to clean the steam nozzle	90
8	Troubleshooting	91
8.1	Error message example	91
8.2	Error messages	92
8.3	FAQs	100
8.3.1	Bean hoppers unlocked	100
8.3.2	No water connected	100
8.3.3	No milk dispensed	100
8.3.4	Steam wand is clogged	100
8.3.5	Cups on the cup heater are not warm enough	100



9	Options	101
9.1	Option list	101
9.2	E'fridge	102
9.2.1	Refill	102
9.2.2	Optional countertop cut-out dimensions.....	103
9.3	E'cup heater	104
9.4	E'choco	105
9.4.1	Technical specifications (datasheet)	106
9.4.2	Fill with powder.....	107
9.4.3	Make a powder drink.....	107
9.4.4	E'choco Daily care (Automatic system cleaning)	108
9.4.5	E'choco Weekly care	110
9.5	Undercounter ground coffee disposal	111
9.6	Without steam wand	111
9.7	Cold milk foam	112
9.8	Option selection 2 types of milk	112
9.9	Decaffeinated powder chute	113
9.10	Bean hopper lock	114
9.11	1.5-Step (milk arm)	114
9.12	Cup centring	115
9.13	Colours	115
10	Warranty and Generalities	117
10.1	Warranty	117
10.2	Warranty limitation.....	118
10.3	Glossary	119
10.3.1	Acronyms	119
10.3.2	«Persons»	119
10.3.3	Injury	120
10.3.4	Products.....	121
10.3.5	Coffee terms	121
10.4	Typographical conventions	122
10.4.1	Warning	122
10.4.2	Note	122
10.4.3	Notation	122



11	Appendix	123
11.1	Equipment list.....	123
11.2	Spare Parts Ordering	124
11.3	User rights	124
11.3.1	Statistic/History.....	124
11.3.2	Product & Keys (e.g. Cappuccino).....	125
11.3.3	Display.....	126
11.3.4	Beans & Grinder.....	127
11.3.5	Clean/Standby.....	128
11.3.6	Password	128
11.3.7	Other settings and parameters	128

For Your Safety 1

This chapter sets out the intended use and safety instructions to ensure safe and trouble-free operation of the Enigma and its associated software. It also describes handling and storage conditions.



The instructions contained in this User Manual must be adhered to in particular the safety instructions. Ensure that all «Persons» have access to the User Manual.

Before carrying out any operation on the Enigma, it is imperative to read this chapter and fully understand it. In case of any doubt, consult your local service organisation.

1.1 Intended use

This Enigma coffee machine is exclusively intended to grind, brew and dispense hot coffee, hot water, hot milk, cold milk and steam (depending on model). The coffee machine is designed for indoor usage and is intended for commercial use only (e.g. food services, restaurants and hotels).

Do not use this coffee machine to produce any other product or for any other purpose.



To change coffee settings it is necessary to have the appropriate access rights. Please refer to chapter [“11.3 User rights” on page 124](#) for more details.

Model types

Three Enigma and Shotmaster models are available, intended to:

- ct; dispense coffee and tea.
- s (s-pro) (s x-wide); dispense coffee, tea and steam.
- m (m-pro) (m x-wide); dispense coffee, tea, steam and milk.

Accessories designed for use with Enigma and Shotmaster:

- E'choco; connected accessory to dispense powder products (e.g. chocolate powder).
- E'fridge beside; standalone fridge.
- E'cup heater; standalone cup warmer.

1.2 Introduction

1.2.1 Importance of the safety instructions

In order to prevent accidents to persons, damage to equipment or pollution of the environment, you must comply with all the safety instructions in this User Manual and on the machine.

Observe the bylaws and the recognised technical rules which apply in the country of use of the Enigma.

1.2.2 Disregarding the safety rules

Disregarding the safety rules, as well as existing legal and technical regulations, may lead to accidents, damage to property or environmental pollution.

Disregarding the instructions for use given by the manufacturer may reduce the level of protection offered by the Enigma.

1.3 Directives



This Enigma complies with all applicable European Community Directives and associated harmonised standards.

For more information refer to our [Declaration of Conformity](#) or contact your Service organisation.



1.4 General safety instructions



Keep the Enigma away from potential sources of interference.

Do not expose the Enigma to direct sunlight, heat, dust or excessive humidity (use only in a clean food service environment).



RISK OF ELECTROCUTION

The power plug is the device used for disconnection in case of problems or emergency and it must be easily accessible at all times.

Only use the power cord provided with the machine.

Never use a machine which is damaged or has a defective power cord. With signs of damage, for example if there is a smell of burning or visible insulation damage, unplug the machine, immediately stop using it and contact your local service organisation.

The power cord must only be repaired by a service organisation appointed by the manufacturer.

Make sure that the cable is not near a hot surface.

Be careful to ensure that the power cord is not trapped and does not rub against sharp edges.

Repair, commissioning and service operations must only be performed by a service organisation appointed by the manufacturer.

Never open the machine, nor remove any parts except for the instructions specified in this manual.

Only connect the Enigma to the electrical power sources specified and a power supply network provided with a protective earth.

Requirement for Australian deviation: disconnection incorporated in the fixed wiring is in accordance with AS/NZS 3000.

Do not immerse the appliance in water.



RISK OF BURNS OR SCALDING

The hot water, steam, milk and coffee dispensed are hot. Avoid direct contact with the skin.

Always place a suitable cup under the outlet before dispensing products.

During automatic cleaning, hot cleaning solution and steam are released several times.

Keep hands and skin away from the outlets.



IRRITANT PRODUCTS

Everclean™ and Eversys cleaning balls™ should be considered potentially dangerous. When performing any operation on the Enigma, local safety regulations must be followed. It is imperative to wear protective gloves and glasses when working with potentially dangerous materials.

For any other materials referred to in this manual (e.g. Everclean™ and Eversys cleaning balls™) corresponding safety data sheets should be consulted before the first use, adequate protective measures should be applied and any applicable regulations should be followed.

Safety data sheets are available under the [Eversys Login area](#).



It is imperative to use only the products, accessories, spare parts and software specified in this manual.

The powder chute, the bean hoppers, and the Eversys cleaning ball dispenser may only be filled with materials for the use intended.



Except for cups, do not place anything on top or above the Enigma.

The machine is not suitable for installation in an area where a water jet or water spray might be used.

The machine must not be located on a surface that is sprayed or cleaned with a water hose, steam jets, steam cleaner, or similar equipment.

The machine must be placed and levelled on a horizontal, water-resistant, heatproof, and sturdy base capable of bearing its weight, see ["2.3 Technical data" on page 23](#).

For operating, service and safety reasons the machine should be installed with a clearance of not less than 50 mm at the back and sides from the building or non-approved equipment. A minimum working space of 650 mm in front the coffee machine and overhead clearance of at least 250 mm above the bean hoppers are recommended. A clear height of 850 mm from the top of the installation surface should be ensured. The height of the installation surface above the floor is at least 800 mm. If the coffee machine connections are to be run downwards through the counter, please make space for the lines, which can reduce the usable space below the coffee machine.

The machine is only to be installed in locations where its use and maintenance is restricted to trained personnel. Please refer to ["10.3.2 «Persons»" on page 119](#).

Only connect the machine to the mains in accordance with the information on the rating plate ["2.3.16 Rating plate" on page 39](#).

Adjustment of the frequency is automatic. No action is required.

The power cord must be in accordance with local regulations. Voltage/current specifications are as listed in the table ["Electrical data and power overview" on page 23](#).



To connect the machine to the water mains, use the original supplied hoses only.

Any necessary on-site preparatory work for electricity, water and drainage connections at the customer's premises is to be arranged by the machine owner/manager. The work must be carried out by authorised installation technicians in compliance with general, country-specific and local regulations. Eversys service organisations may only connect the coffee machine to existing prepared connection points. Eversys appointed service organisations are neither authorised, nor responsible for carrying out any on-site installation work prior to connection.



Always switch off the machine at the main switch before undertaking cleaning tasks. Use only a damp cloth and protect the machine against permanent water projections.

Regular cleaning is mandatory in order to ensure problem-free operation of the coffee machine and to ensure optimum coffee quality. Refer to method and frequency under [“7 Care” on page 75](#).

Only use original Eversys cleaning products. Use of products that are not explicitly recommended by Eversys could damage the machine.

It is forbidden to clean the machine with a water jet or a water spray.

Make sure to have your machine maintained at regular intervals to ensure safe and efficient performance. Refer to [“7.1.2 Maintenance” on page 77](#).

Risk of spoiled food residue: if the machine is not cleaned regularly, milk and coffee residue may accumulate in the machine, clog the outlets or get into drinks. Clean the coffee machine and add-on according to [“7.2.1 Cleaning plan” on page 78](#) and [“7.2.2 Cleaning table” on page 79](#).



People, including children, who, because of their physical, sensory or cognitive abilities, or due to their inexperience or lack of knowledge, are not able to use this machine safely, are not allowed to operate it unless under the supervision or on the order of a responsible person.

The machine is not suitable for children under the age of 8 years. Children above the age of 8 or persons who are challenged with respect to physical, sensory or mental abilities must never approach the machine alone and must always be supervised.

Children are not allowed to play with the machine.

Children are not permitted to perform any cleaning on the machine.



Do not put the Enigma or any of its component parts in the dishwasher.

Never use coffee beans treated with additives or caramelised.

In case of prolonged absence (short-term storage), switch off the machine using the main power switch and close the water tap.



1.5 Information for disposal

The disposal and/or recycling of materials must be performed in accordance with the legislation in force.

This machine and its accessories must be recycled.

Subject to separate collection of electric and electronic equipment and accessories for the purpose of recycling.

Electrical and electronic equipment may contain dangerous substances which constitute health and environmental hazards. The owner must return the device to its dealer or establish direct contact with an approved body for treatment and recovery of this type of equipment.

Symbol	Description
	<p>Separate collection of electric and electronic equipment.</p> <p>This machine is marked in compliance with European Directive 2012/19/EU, Waste Electrical and Electronic Equipment (WEEE).</p>
	<p>General symbol for recovery/recyclable</p>

1.6 Decommissioning and disposal



Contact your local service organisation for long term decommissioning and disposal.

1.6.1 Packaging material

The packaging material (cardboard, PE plastic film, PE, PE-foam, EPS) must be recycled or disposed of according to the local regulations.

1.6.2 Removal of equipment









Disconnect the coffee machine from the power supply and water mains. If the coffee machine is hard-wired, it must be disconnected by an authorised service agent.

1.7 Special safety instructions and signs





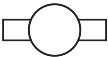

Appropriate safety instructions are mentioned in the specific chapters. They should be observed in the same way as the general safety instructions contained in this chapter.

1.7.1 Signs

The following signs can be found on the Enigma. Associated warnings are explained in the table.

Sign	Description	Explanation
	Caution, consult accompanying documents	-
	High voltage - Danger	ELECTROCUTION During maintenance work, always power off the machine using the main switch (see "5.9" on page 63).
	Burning - Danger	HOT SURFACE Contact may cause burns. Do not touch.
	Corrosive product	CORROSIVE Causes severe burns. Avoid contact with skin and eyes.
	Main switch	Power ON.
	Main switch	Power OFF.
	Main water inlet	Water tap open (See "2.2.2" on page 20).
	Main water inlet	Water tap closed.
	Protective earthing	-

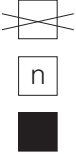
1.8 Packaging signs

Symbol	Description
	Fragile, handle with care.
	Keep dry.
	Keep upright.
	Maximum and minimum humidity limit.
	Maximum and minimum temperature limit.
	Stacking limit by number. Not to be vertically stacked higher than the specified number of items «n».
	Phytosanitary treatment of the pallet.
	Serial Number.

Description 2

Chapter Overview

This chapter offers a general overview and presentation of the Enigma.

2.1 Identification

The Enigma is a super automatic coffee machine that automates the entire process of making a perfect Barista coffee drink. The Enigma coffee machine has numerous options. An overview of your machine is illustrated in the following chapters. Please note that your coffee machine may look different from the configuration shown in this manual (Enigma E'4m/Classic).



The technical specifications, illustrations and dimensions contained in these instructions are given merely as an indication. They shall not give rise to any claim.

For any further information, please consult your local distributor or [see "Manufacturer" on page 2](#).

2 Description



2.1.1 Enigma Key features

Enigma model	E'2ct	E'2s	E'2m	E'4s	E'4m	E'4s x-wide	E'4m x-wide	E'6s	E'6m
Products at the same time	2	2	2	4	4	4	4	6	6
Coffee products and hot water (coffee outlet)	✓	✓	✓	✓	✓	✓	✓	✓	✓
Hot water outlet	✓	✓	✓	✓	✓	✓	✓	✓	✓
Steam products (steam wand)	✗	✓	✓	✓	✓	✓	✓	✓	✓
e'Foam Micro Air Dosing (MAD)	✗	✓	✓	✓	✓	✓	✓	✓	✓
Electronic Milk Texturing (EMT) (coffee outlet)	✗	✗	✓	✗	✓	✗	✓	✗	✓
1.5-Step (optional)	✗	✗	✓	✗	✓	✗	✓	✗	✓
e'Levelling	✓	✓	✓	✓	✓	✓	✓	✓	✓
Front LED	✓	✓	✓	✓	✓	✓	✓	✓	✓
CCI/CSI/API Connection	✓	✓	✓	✓	✓	✓	✓	✓	✓
e'Connect (Telemetry)	✓	✓	✓	✓	✓	✓	✓	✓	✓
Tempest	✓	✓	✓	✓	✓	✓	✓	✓	✓
Earth	✓	✓	✓	✓	✓	✓	✓	✓	✓
Colour customisation	✓	✓	✓	✓	✓	✓	✓	✓	✓

2.1.2 Shotmaster Key features

Shotmaster model	ct	s	m	s/pro	m/pro
Products at the same time	4	4	4	8	8
Coffee products and hot water (coffee outlet)	✓	✓	✓	✓	✓
Hot water outlet	✗	✓	✓	✓	✓
Steam products (steam wand)	✗	✓	✓	✓	✓
e'Foam Micro Air Dosing (MAD)	✗	✓	✓	✓	✓
Electronic Milk Texturing (EMT) (coffee outlet)	✗	✗	✓	✗	✓
1.5-Step (optional)	✗	✗	✓	✗	✓
e'Levelling	✓	✓	✓	✓	✓
Front LED	✓	✓	✓	✓	✓
CCI/CSI/API Connection	✓	✓	✓	✓	✓
e'Connect (Telemetry)	✓	✓	✓	✓	✓
Tempest	✓	✓	✓	✓	✓
Earth	✓	✓	✓	✓	✓
Colour customisation	✓	✓	✓	✓	✓

2.1.3 Enigma Classic range (visuals)

Refer to the datasheet visuals (See ["2.3" on page 23](#)) or view machines under our [website](#).

2.2 Overview

2.2.1 Front view

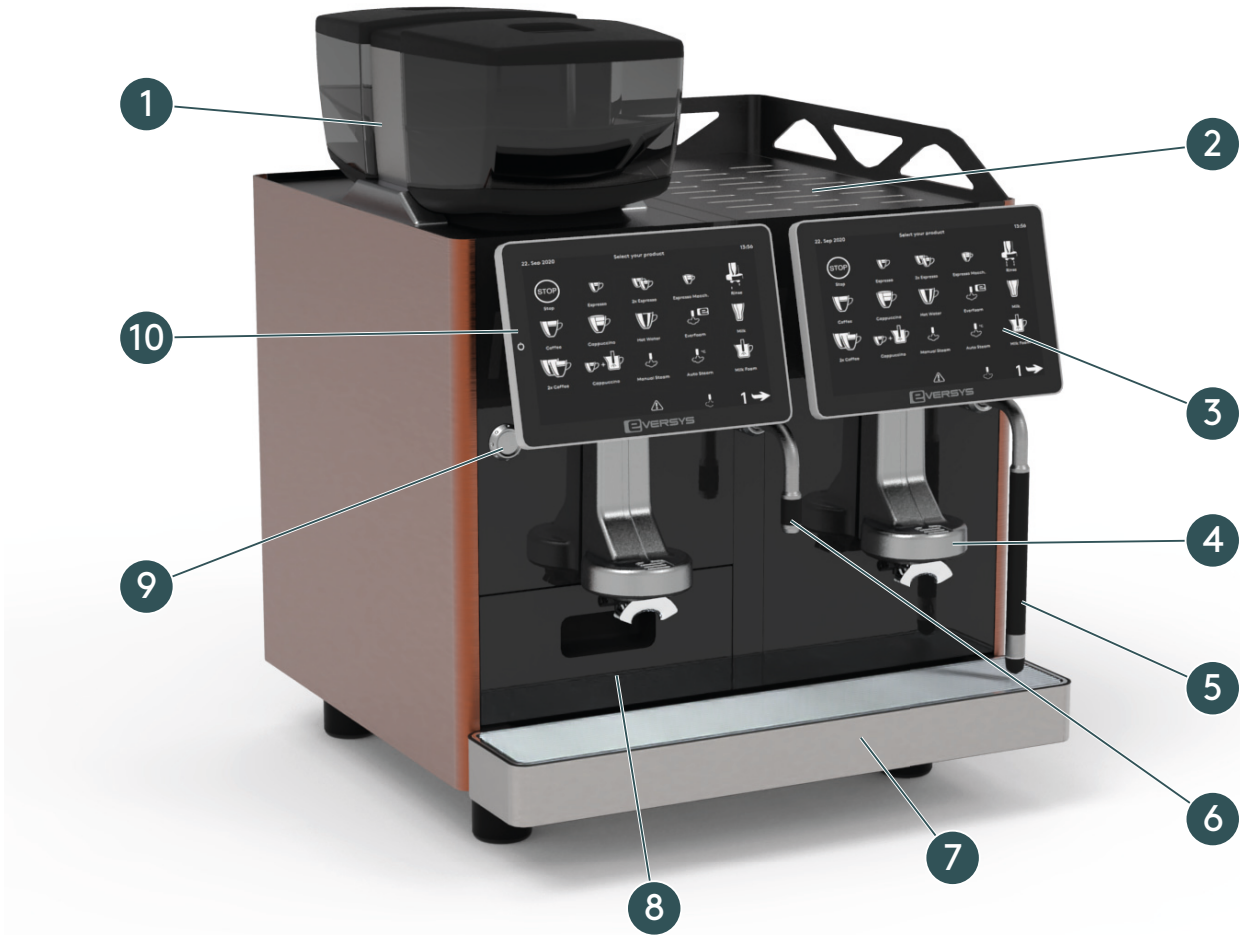

Fig. 2-1

- (1) Bean hoppers and cleaning balls access ([see "2.2.4" on page 22](#))
- (2) Cup warmer surface (Up to 64 espresso cups)
- (3) Touch screen (slave)
- (4) Coffee outlet
- (5) Steam wand (or optional 1.5-Step milk arm, [see "9.12" on page 116](#))
- (6) Hot water outlet
- (7) Drip tray
- (8) Grounds drawer (main power switch access, [see "5.2" on page 54](#))
- (9) Optional outlet
- (10) Touch screen (master)

2 Description



2.2.2 Drip tray open

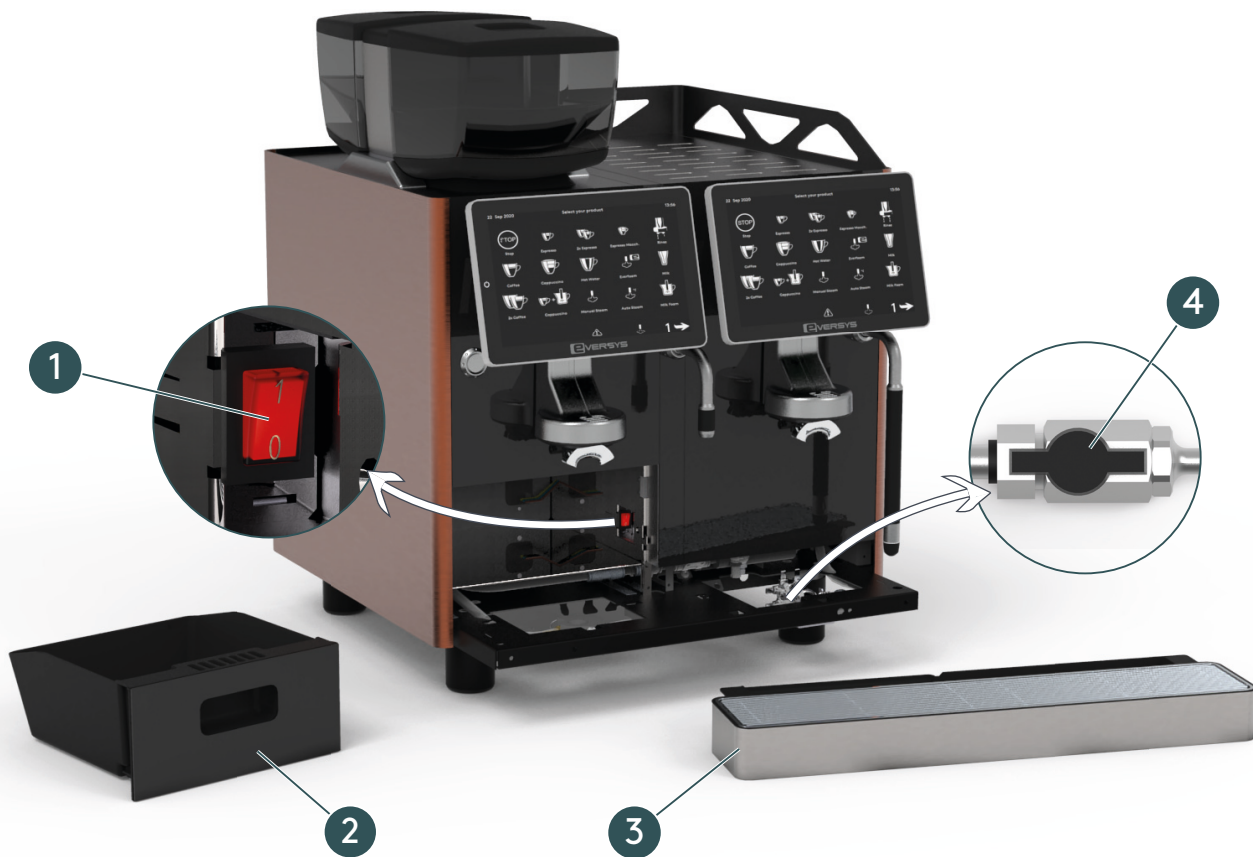

Fig. 2-2

- (1) Main power switch (see "5.2" on page 54)
- (2) Grounds drawer
- (3) Drip tray (open)
- (4) Water inlet (open)

2.2.3 Touch screen

The touch screen and the graphical user interface are touch-sensitive.

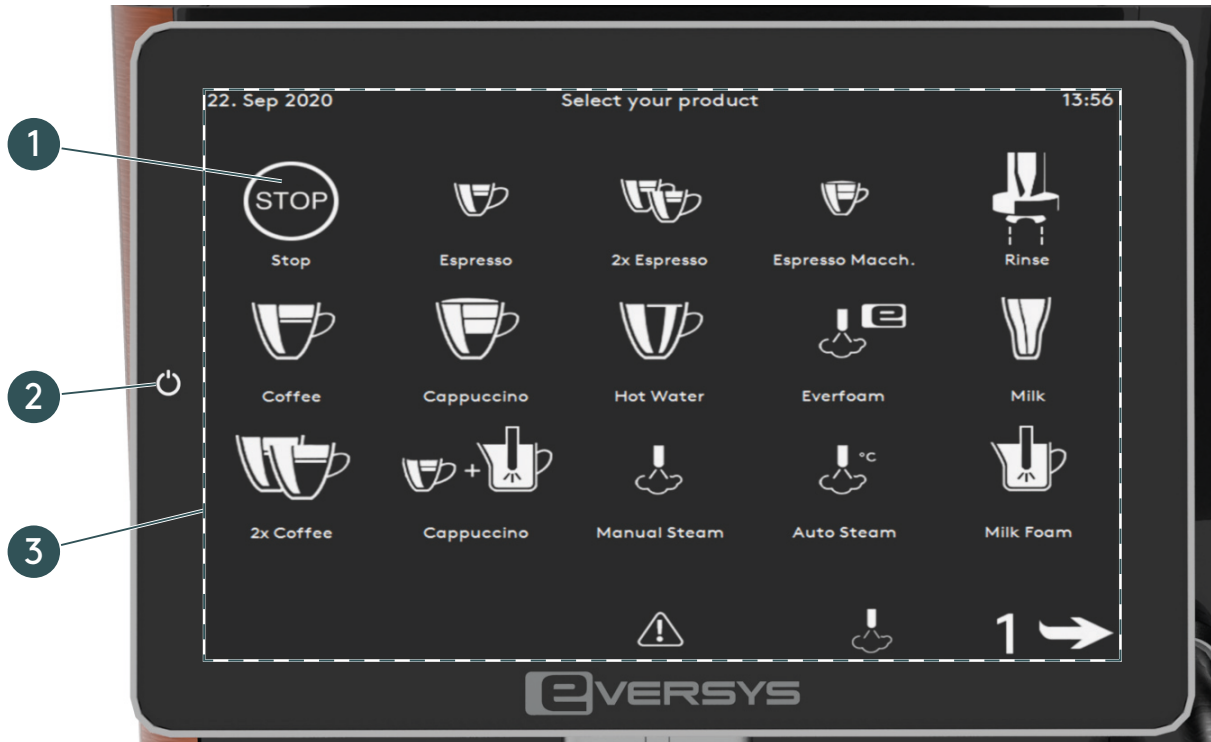

Fig. 2-3

- (1) Stop touch button (See "5.7" on page 61)
- (2) Standby button (See "5.2.1" on page 54)
- (3) Graphical user interface (products may vary according to settings and Enigma model) (See "3" on page 45)



Display of the stop and standby buttons also depend on the settings.

See chapter "11.3 User rights" on page 124.

For Shotmaster s/Classic and m/Classic and s-pro/ST m-pro/ST, the display of the menu changes according to the outlets installed.

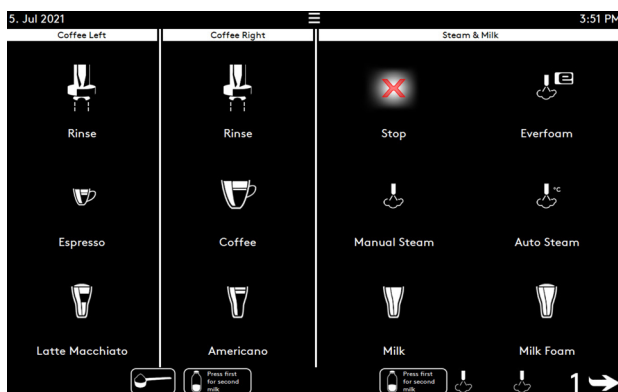

2 Description



2.2.4 Top view (bean hopper)



Fig. 2-4

- | | |
|---------------------------------------|---------------------------------|
| (1) Eversys cleaning balls™ dispenser | (4) Eversys cleaning balls™ lid |
| (2) Bean hopper (rear) | (5) Bean hopper (front) |
| (3) Bean hopper lid (rear) | (6) Bean hopper lid (front) |



Optional red lid for the cleaning balls available see [“9 Options” on page 101](#) for more information.

2.3 Technical data

Performance



Performance depends on cup size and machine settings.

Article number

Enigma Classic

Model	E'2ct	E'2s	E'2m	E'4s	E'4m	E'4s x-wide	E'4m x-wide	E'6s	E'6m
SAP	0E50000013	0E50000014	0E50000019	0E50000015	0E50000016	0E50000017	0E50000018	0E50000021	0E50000022

Enigma ST

Model	E'2ct/ST	E'2s/ST	E'2m/ST	E'4s/ST	E'4m/ST	E'4s x-wide/ST	E'4m x-wide/ST	E'6s/ST	E'6mS/T
SAP	0E50000027	0E50000028	0E50000029	0E50000030	0E50000031	0E50000032	0E50000033	0E50000034	0E50000035

Enigma Shotmaster/Classic

Model	ct	s	m
SAP	0E50000020	0E50000023	0E50000024

Enigma Shotmaster/ST

Model	ct/ST	s/ST	m/ST	s-pro/ST	m-pro/ST
SAP	0E50000036	0E50000037	0E50000038	0E50000039	0E50000040

Electrical data and power overview



The power cord and plug must be in accordance with local regulations. Adjustment of the frequency is automatic. No action is required.

Environmental conditions



Do not use the Enigma outside of the defined ranges of environmental conditions.

Description	Enigma
Operating temperature	10°C to 32°C
Storage & transport temperature	-10°C to 50°C (boilers empty).
Relative humidity, no condensing	5 to 80% RH (storage, transport and operating)
Transient over-voltage	Category II

Power configurations (Voltage/Power) of all countries

Please view [e'Support](#) follow this link: <https://bit.ly/3zxloSP>

2 Description

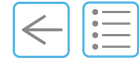

2.3.1 E'2ct datasheet



E'2ct/Classic

Select your colour:	Select your region:	
Earth <input checked="" type="checkbox"/>	Asia <input checked="" type="checkbox"/>	Oceania <input checked="" type="checkbox"/>
Tempest <input checked="" type="checkbox"/>	Central - South America <input checked="" type="checkbox"/>	North America <input checked="" type="checkbox"/>
	Europe <input checked="" type="checkbox"/>	Middle East <input checked="" type="checkbox"/>

Technical data	
Brew chamber	1 x 24 g
Grinder	2 x Ceramic burrs - 64 mm
User Interface	1 x Touch screen 256 mm (10.1")
Bean hopper	2 x 1.5 kg
Coffee outlet height*	190 mm max.
Hot water outlet height*	160 mm max. or 215 mm max. (option)
Interface	2 x USB, 1 x Ethernet, 1 x CCI/CSI
Cup heater surface	-
Coffee boiler size	1 x 1.5 L
Steam boiler size	-
Grounds drawer	1 x 700 g
Drip tray	Standard
Water Connection	
Water hose	Inox braided pipe G3/8" female x 2 m
Drain hose	Ø 22 mm x Ø 16 mm x 2 m

*measured from the drip tray

Classic	E'2ct
Weight	52 kg
Performance (up to)	
Espresso/h (23 s)	175
Hot water/h (200 ml)	170
Cappuccino/h (23 s)	-
Adjustable hot water temperature (Manual)	-
Adjustable hot water temperature (Automatic)	-
e'Foam Micro Air Dosing (MAD) system (controlled electronically)	-
Milk system with EMT (Electronic Milk Texturing)	-
Voltage/Power	
Power consumption (standby mode)	Less than 2 W
2/PE, 208V~, 60Hz, 15A	2300 W
1/N/PE, 220-240V~, 50/60Hz, 16A	2800 W
1/N/PE, 220-240V~, 50/60Hz, 16A - ZH	2800 W
Water pressure and flow	
2.5 - 4 bars (36.3 - 58 psi) If the pressure exceeds 4.5 bars (65.3 psi), it is necessary to install a pressure valve reducer.	
If the main flow rate is under 200 L/h, there is a risk of damaging the water pump.	

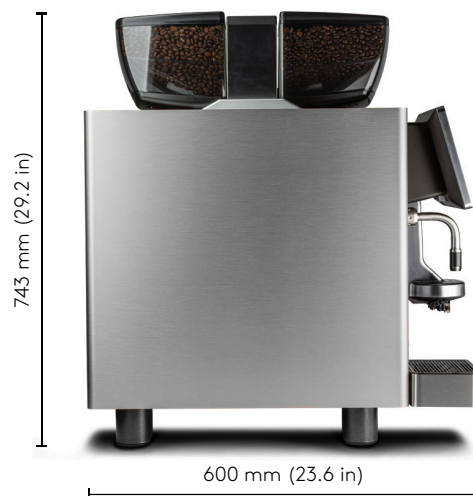
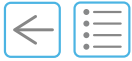

Fig. 2-5



2.3.2 E'2s, E'2m datasheet



E'2m/Classic

Technical data	
Brew chamber	1 x 24 g
Grinder	2 x Ceramic burrs - 64 mm
User Interface	1 x Touch screen 256 mm (10.1")
Bean hopper	2 x 1.5 kg
Coffee outlet height*	190 mm max.
Hot water outlet height*	160 mm max. or 215 mm max. (option)
Interface	2 x USB, 1 x Ethernet, 1 x CCI/CSI
Cup heater surface	Up to 64 espresso cups
Coffee boiler size	1 x 1.5 L
Steam boiler size	5.4 L
Grounds drawer	1 x 700 g
Drip tray	Standard or Large (option) or Large with pitcher rinsers (option)
Water Connection	
Water hose	Inox braided pipe G3/8" female x 2 m
Drain hose	Ø 22 mm x Ø 16 mm x 2 m

*measured from the drip tray

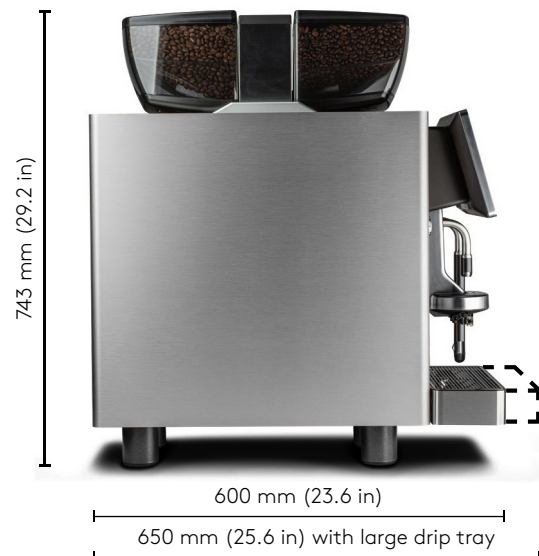

Fig. 2-6

Select your colour:

Earth
Tempest

Select your region:

Asia Oceania
Central - South America North America
Europe Middle East

Classic	E'2s	E'2m
Weight	83 kg	87 kg
Performance (up to)		
Espresso/h (23 s)	175	
Hot water/h (200 ml)	170	
Cappuccino/h (23 s)	-	175
Adjustable hot water temperature (Manual)	Yes	
Adjustable hot water temperature (Automatic)	Option	
e'Foam Micro Air Dosing (MAD) system (controlled electronically)	Yes	
Milk system with EMT (Electronic Milk Texturing)	-	Yes
Voltage/Power		
Power consumption (standby mode)	Less than 2 W	
2/PE, 208V~, 60Hz, 30A	4200 W	
1/N/PE, 220-240V~, 50/60Hz, 25A	5100 W	
2 x 1/N/PE, 220-240V~, 50/60Hz, 25A	7400 W	
1/N/PE, 220-240V~, 50/60Hz, 25A - ZH	5100 W	
2 x 1/N/PE, 220-240V~, 50/60Hz, 25A - ZH	7400 W	
3/N/PE, 380-415V~, 50/60Hz, 16A - ZH	7400 W	
Water pressure and flow		
2.5 - 4 bars (36.3 - 58 psi) If the pressure exceeds 4.5 bars (65.3 psi), it is necessary to install a pressure valve reducer.		
If the main flow rate is under 200 L/h, there is a risk of damaging the water pump.		

2 Description

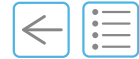

2.3.3 E'4s, E'4m datasheet



E'4m/Classic

Technical data	
Brew chamber	2 x 24 g
Grinder	2 x Ceramic burrs - 64 mm
User Interface	2 x Touch screen 256 mm (10.1")
Bean hopper	2 x 1.5 kg
Coffee outlet height*	190 mm max.
Hot water outlet height*	160 mm max. or 215 mm max. (option)
Interface	2 x USB, 1 x Ethernet, 1 x CCI/CSI or CCI/CSI Double connection (option)
Cup heater surface	Up to 64 espresso cups
Coffee boiler size	2 x 1.5 L
Steam boiler size	5.4 L
Grounds drawer	1 x 700 g
Drip tray	Standard or Large (option)
Water Connection	
Water hose	Inox braided pipe G3/8" female x 2 m
Drain hose	Ø 22 mm x Ø 16 mm x 2 m

*measured from the drip tray



Select your colour:

Earth

Tempest

Select your region:

Asia Oceania

Central - South America North America

Europe Middle East

Classic	E'4s	E'4m
Weight	90 kg	94 kg
Performance (up to)		
Espresso/h (23 s)	350	
Hot water/h (200 ml)	170	
Cappuccino/h (23 s)	-	350
Adjustable hot water temperature (Manual)	Yes	
Adjustable hot water temperature (Automatic)	Option	
e'Foam Micro Air Dosing (MAD) system (controlled electronically)	Yes	
Milk system with EMT (Electronic Milk Texturing)	-	Yes
Voltage/Power		
Power consumption (standby mode)	Less than 2 W	
2/PE, 208V~, 60Hz, 30A	4600 W	
1/N/PE, 220-240V~, 50/60Hz, 25A	5600 W	
2 x 1/N/PE, 220-240V~, 50/60Hz, 25A	10200 W	
1/N/PE, 220-240V~, 50/60Hz, 25A - ZH	5600 W	
2 x 1/N/PE, 220-240V~, 50/60Hz, 25A - ZH	10200 W	
3/N/PE, 380-415V~, 50/60Hz, 16A - ZH	7900 W	
Water pressure and flow		
2.5 - 4 bars (36.3 - 58 psi) If the pressure exceeds 4.5 bars (65.3 psi), it is necessary to install a pressure valve reducer.		
If the main flow rate is under 200 L/h, there is a risk of damaging the water pump.		



Fig. 2-7

2.3.4 E'4s x-wide, E'4m x-wide datasheet



E'4m x-wide/Classic

Technical data	
Brew chamber	2 x 24 g
Grinder	2 x Ceramic burrs - 64 mm
User Interface	2 x Touch screen 256 mm (10.1")
Bean hopper	2 x 1.5 kg
Coffee outlet height*	190 mm max.
Hot water outlet height*	160 mm max. or 215 mm max. (option)
Interface	2 x USB, 1 x Ethernet, 1 x CCI/CSI or CCI/CSI Double connection (option)
Cup heater surface	Up to 128 espresso cups
Coffee boiler size	2 x 1.5 L
Steam boiler size	5.4 L
Grounds drawer	1 x 700 g
Drip tray	Standard or Large (option) or Large with pitcher rinsers (option)
Water Connection	
Water hose	Inox braided pipe G3/8" female x 2 m
Drain hose	Ø 22 mm x Ø 16 mm x 2 m

*measured from the drip tray

Select your colour:

Earth

Tempest

Select your region:

Asia Oceania

Central - South America North America

Europe Middle East

Classic	E'4s x-wide	E'4m x-wide
Weight	115 kg	119 kg
Performance (up to)		
Espresso/h (23 s)		350
Hot water/h (200 ml)		170
Cappuccino/h (23 s)	-	350
Adjustable hot water temperature (Manual)		Yes
Adjustable hot water temperature (Automatic)		Option
e'Foam Micro Air Dosing (MAD) system (controlled electronically)		Yes
Milk system with EMT (Electronic Milk Texturing)	-	Yes
Voltage / Power		
Power consumption (standby mode)		Less than 2 W
2/PE, 208V~, 60Hz, 30A		4600 W
1/N/PE, 220-240V~, 50/60Hz, 25A		5600 W
2 x 1/N/PE, 220-240V~, 50/60Hz, 25A		10200 W
1/N/PE, 220-240V~, 50/60Hz, 25A - ZH		5600 W
2 x 1/N/PE, 220-240V~, 50/60Hz, 25A - ZH		10200 W
3/N/PE, 380-415V~, 50/60Hz, 16A - ZH		7900 W
Water pressure and flow		
2.5 - 4 bars (36.3 - 58 psi) If the pressure exceeds 4.5 bars (65.3 psi), it is necessary to install a pressure valve reducer.		
If the main flow rate is under 200 L/h, there is a risk of damaging the water pump.		

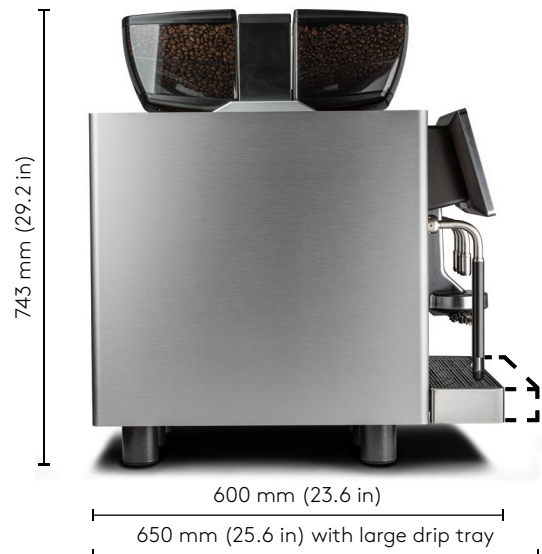
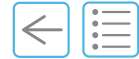

Fig. 2-8

2 Description



2.3.5 E'6s, E'6m datasheet



E'6m/Classic

Technical data	
Brew chamber	3 x 24 g
Grinder	4 x Ceramic burrs - 64 mm
User Interface	3 x Touch screen 256 mm (10.1")
Bean hopper	4 x 1.5 kg
Coffee outlet height*	190 mm max.
Hot water outlet height*	160 mm max. or 215 mm max. (option)
Interface	4 x USB, 2 x Ethernet, 2 x CCI/CSI
Cup heater surface	Up to 64 espresso cups
Coffee boiler size	3 x 1.5 L
Steam boiler size	5.4 L
Grounds drawer	2 x 700 g
Drip tray	Standard or Large (option)
Water Connection	
Water hose	Inox braided pipe G3/8" female x 2 m
Drain hose	Ø 22 mm x Ø 16 mm x 2 m

*measured from the drip tray

Select your colour:	Select your region:
Earth <input checked="" type="checkbox"/>	Asia <input checked="" type="checkbox"/> Oceania <input checked="" type="checkbox"/>
Tempest <input checked="" type="checkbox"/>	Central - South America <input checked="" type="checkbox"/> North America <input checked="" type="checkbox"/>
	Europe <input checked="" type="checkbox"/> Middle East <input checked="" type="checkbox"/>

Classic	E'6s	E'6m
Weight	142 kg	150 kg
Performance (up to)		
Espresso/h (23 s)	525	
Hot water/h (200 ml)	170	
Cappuccino/h (23 s)	-	350
Adjustable hot water temperature (Manual)	Yes	
Adjustable hot water temperature (Automatic)	Option	
eFoam Micro Air Dosing (MAD) system (controlled electronically)	Yes	
Milk system with EMT (Electronic Milk Texturing)	-	Yes
Voltage/Power		
Power consumption (standby mode)	Less than 2 W	
2/PE, 208V~, 60Hz, 30A	4600 + 2300 W	
1/N/PE, 220-240V~, 50/60Hz, 25A	5600 + 2800 W	
2 x 1/N/PE, 220-240V~, 50/60Hz, 25A	10200 + 2800 W	
1/N/PE, 220-240V~, 50/60Hz, 25A - ZH	5600 + 2800 W	
2 x 1/N/PE, 220-240V~, 50/60Hz, 25A - ZH	10200 + 2800 W	
3/N/PE, 380-415V~, 50/60Hz, 16A - ZH	7900 + 2800 W	
Water pressure and flow		
2.5 - 4 bars (36.3 - 58 psi) If the pressure exceeds 4.5 bars (65.3 psi), it is necessary to install a pressure valve reducer.		
If the main flow rate is under 200 L/h, there is a risk of damaging the water pump.		

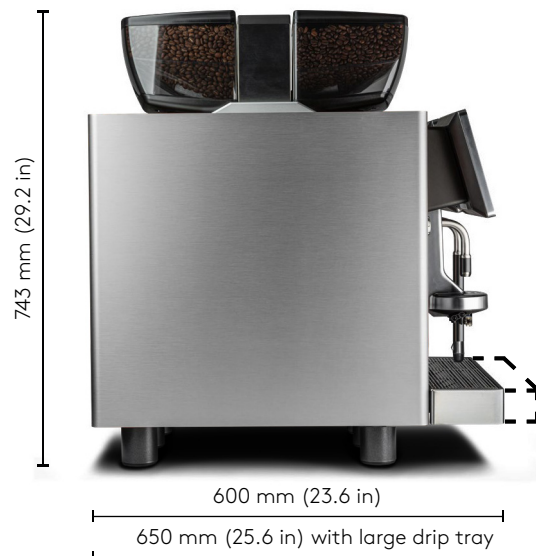

Fig. 2-9



2.3.6 E'2ct/ST datasheet



E'2ct/ST

Select your region:

Asia	<input checked="" type="checkbox"/>	Oceania	<input checked="" type="checkbox"/>
Central - South America	<input checked="" type="checkbox"/>	North America	<input checked="" type="checkbox"/>
Europe	<input checked="" type="checkbox"/>	Middle East	<input checked="" type="checkbox"/>

Technical data	
Brew chamber	1 x 24 g
Grinder	2 x Ceramic burrs - 64 mm
User Interface	1 x Touch screen 256 mm (10.1")
Bean hopper	2 x 1.5 kg
Coffee outlet height*	190 mm max.
Hot water outlet height*	160 mm max. or 215 mm max. (option)
Interface	2 x USB, 1 x Ethernet, 1 x CCI/CSI
Cup heater surface	-
Coffee boiler size	1 x 1.5 L
Steam boiler size	-
Grounds drawer	1 x 700 g
Drip tray	Standard
Water Connection	
Water hose	Inox braided pipe G3/8" female x 2 m
Drain hose	Ø 22 mm x Ø 16 mm x 2 m

*measured from the drip tray

Super Traditional	E'2ct
Weight	58 kg
Performance (up to)	
Espresso/h (23 s)	175
Hot water/h (200 ml)	170
Cappuccino/h (23 s)	-
Adjustable hot water temperature (Manual)	-
Adjustable hot water temperature (Automatic)	-
e'Foam Micro Air Dosing (MAD) system (controlled electronically)	-
Milk system with EMT (Electronic Milk Texturing)	-
Voltage/Power	
Power consumption (standby mode)	Less than 2 W
2/PE, 208V~, 60Hz, 15A	2300 W
1/N/PE, 220-240V~, 50/60Hz, 16A	2800 W
1/N/PE, 220-240V~, 50/60Hz, 16A - ZH	2800 W
Water pressure and flow	
2.5 - 4 bars (36.3 - 58 psi) If the pressure exceeds 4.5 bars (65.3 psi), it is necessary to install a pressure valve reducer.	
If the main flow rate is under 200 L/h, there is a risk of damaging the water pump.	



289 mm (11.4 in)

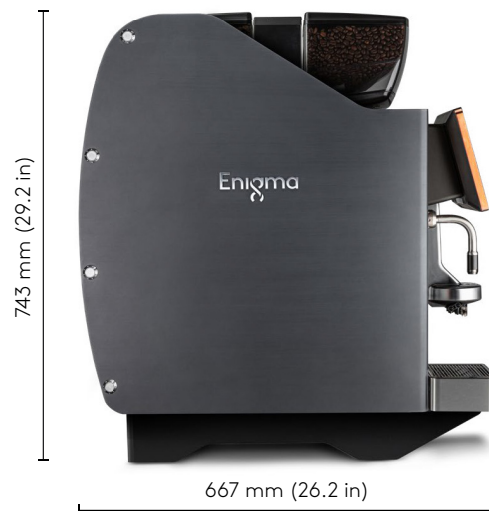

743 mm (29.2 in)

667 mm (26.2 in)

Fig. 2-10

2 Description

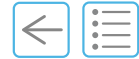

2.3.7 E'2s/ST, E'2m/ST datasheet



E'2m/ST

Select your region:

Asia	<input checked="" type="checkbox"/>	Oceania	<input checked="" type="checkbox"/>
Central - South America	<input checked="" type="checkbox"/>	North America	<input checked="" type="checkbox"/>
Europe	<input checked="" type="checkbox"/>	Middle East	<input checked="" type="checkbox"/>

Technical data	
Brew chamber	1 x 24 g
Grinder	2 x Ceramic burrs - 64 mm
User Interface	1 x Touch screen 256 mm (10.1")
Bean hopper	2 x 1.5 kg
Coffee outlet height*	190 mm max.
Hot water outlet height*	160 mm max. or 215 mm max. (option)
Interface	2 x USB, 1 x Ethernet, 1 x CCI/CSI
Cup heater surface	Up to 64 espresso cups
Coffee boiler size	1 x 1.5 L
Steam boiler size	5.4 L
Grounds drawer	1 x 700 g
Drip tray	Standard or Large (option) or Large with pitcher rinsers (option)
Water Connection	
Water hose	Inox braided pipe G3/8" female x 2 m
Drain hose	Ø 22 mm x Ø 16 mm x 2 m

*measured from the drip tray

Super Traditional	E'2s	E'2m
Weight	93 kg	97 kg
Performance (up to)		
Espresso/h (23 s)	175	
Hot water/h (200 ml)	170	
Cappuccino/h (23 s)	-	175
Adjustable hot water temperature (Manual)	Yes	
Adjustable hot water temperature (Automatic)	Option	
e'Foam Micro Air Dosing (MAD) system (controlled electronically)	Yes	
Milk system with EMT (Electronic Milk Texturing)	-	Yes
Voltage/Power		
Power consumption (standby mode)	Less than 2 W	
2/PE, 208V~, 60Hz, 30A	4200 W	
1/N/PE, 220-240V~, 50/60Hz, 25A	5100 W	
2 x 1/N/PE, 220-240V~, 50/60Hz, 25A	7400 W	
1/N/PE, 220-240V~, 50/60Hz, 25A - ZH	5100 W	
2 x 1/N/PE, 220-240V~, 50/60Hz, 25A - ZH	7400 W	
3/N/PE, 380-415V~, 50/60Hz, 16A - ZH	7400 W	
Water pressure and flow		
2.5 - 4 bars (36.3 - 58 psi) If the pressure exceeds 4.5 bars (65.3 psi), it is necessary to install a pressure valve reducer.		
If the main flow rate is under 200 L/h, there is a risk of damaging the water pump.		

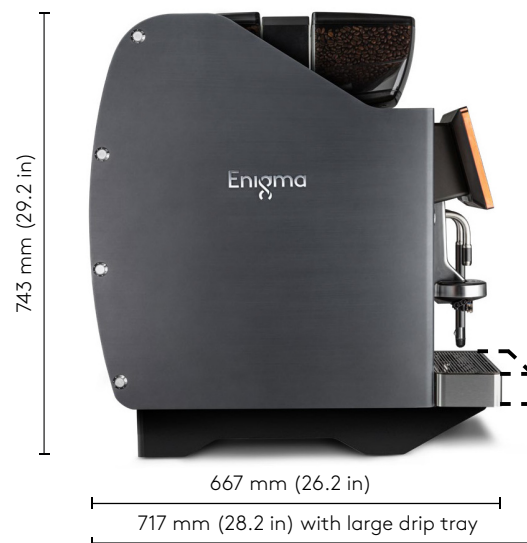

Fig. 2-11



2.3.8 E'4s/ST, E'4m/ST datasheet



E'4m/ST

Select your region:

Asia	<input checked="" type="checkbox"/>	Oceania	<input checked="" type="checkbox"/>
Central - South America	<input checked="" type="checkbox"/>	North America	<input checked="" type="checkbox"/>
Europe	<input checked="" type="checkbox"/>	Middle East	<input checked="" type="checkbox"/>

Technical data	
Brew chamber	2 x 24 g
Grinder	2 x Ceramic burrs - 64 mm
User Interface	2 x Touch screen 256 mm (10.1")
Bean hopper	2 x 1.5 kg
Coffee outlet height*	190 mm max.
Hot water outlet height*	160 mm max. or 215 mm max. (option)
Interface	2 x USB, 1 x Ethernet, 1 x CCI/CSI or CCI/CSI Double connection (option)
Cup heater surface	Up to 64 espresso cups
Coffee boiler size	2 x 1.5 L
Steam boiler size	5.4 L
Grounds drawer	1 x 700 g
Drip tray	Standard or Large (option)
Water Connection	
Water hose	Inox braided pipe G3/8" female x 2 m
Drain hose	Ø 22 mm x Ø 16 mm x 2 m

*measured from the drip tray

Super Traditional	E'4s	E'4m
Weight	100 kg	104 kg
Performance (up to)		
Espresso/h (23 s)	350	
Hot water/h (200 ml)	170	
Cappuccino/h (23 s)	-	350
Adjustable hot water temperature (Manual)	Yes	
Adjustable hot water temperature (Automatic)	Option	
e'Foam Micro Air Dosing (MAD) system (controlled electronically)	Yes	
Milk system with EMT (Electronic Milk Texturing)	-	Yes
Voltage/Power		
Power consumption (standby mode)	Less than 2 W	
2/PE, 208V~, 60Hz, 30A	4600 W	
1/N/PE, 220-240V~, 50/60Hz, 25A	5600 W	
2 x 1/N/PE, 220-240V~, 50/60Hz, 25A	10200 W	
1/N/PE, 220-240V~, 50/60Hz, 25A - ZH	5600 W	
2 x 1/N/PE, 220-240V~, 50/60Hz, 25A - ZH	10200 W	
3/N/PE, 380-415V~, 50/60Hz, 16A - ZH	7900 W	
Water pressure and flow		
2.5 - 4 bars (36.3 - 58 psi) If the pressure exceeds 4.5 bars (65.3 psi), it is necessary to install a pressure valve reducer.		
If the main flow rate is under 200 L/h, there is a risk of damaging the water pump.		

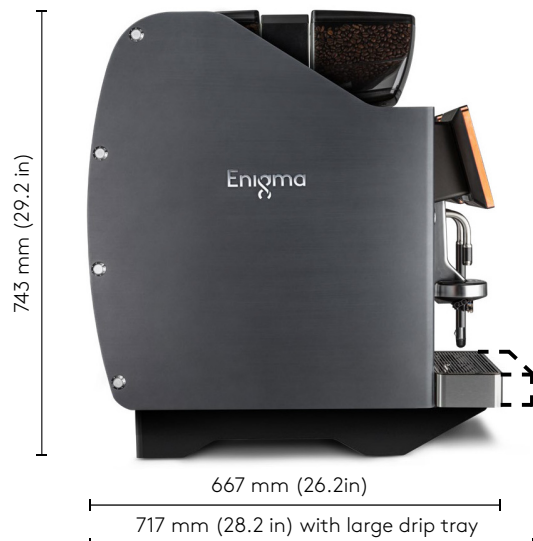
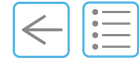

Fig. 2-12

2 Description



2.3.9 E'4s x-wide/ST, E'4m x-wide/ST datasheet



E'4m x-wide/ST

Technical data	
Brew chamber	2 x 24 g
Grinder	2 x Ceramic burrs - 64 mm
User Interface	2 x Touch screen 256 mm (10.1")
Bean hopper	2 x 1.5 kg
Coffee outlet height*	190 mm max.
Hot water outlet height*	160 mm max. or 215 mm max. (option)
Interface	2 x USB, 1 x Ethernet, 1 x CCI/CSI or CCI/CSI Double connection (option)
Cup heater surface	Up to 128 espresso cups
Coffee boiler size	2 x 1.5 L
Steam boiler size	5.4 L
Grounds drawer	1 x 700 g
Drip tray	Standard or Large (option) or Large with pitcher rinsers (option)
Water Connection	
Water hose	Inox braided pipe G3/8" female x 2 m
Drain hose	Ø 22 mm x Ø 16 mm x 2 m

*measured from the drip tray

Select your region:

Asia	<input checked="" type="checkbox"/>	Oceania	<input checked="" type="checkbox"/>
Central - South America	<input checked="" type="checkbox"/>	North America	<input checked="" type="checkbox"/>
Europe	<input checked="" type="checkbox"/>	Middle East	<input checked="" type="checkbox"/>

Super Traditional	E'4s x-wide	E'4m x-wide
Weight	127 kg	131 kg
Performance (up to)		
Espresso/h (23 s)	350	
Hot water/h (200 ml)	170	
Cappuccino/h (23 s)	-	350
Adjustable hot water temperature (Manual)	Yes	
Adjustable hot water temperature (Automatic)	Option	
e'Foam Micro Air Dosing (MAD) system (controlled electronically)	Yes	
Milk system with EMT (Electronic Milk Texturing)	-	Yes
Voltage/Power		
Power consumption (standby mode)	Less than 2 W	
2/PE, 208V~, 60Hz, 30A	4600 W	
1/N/PE, 220-240V~, 50/60Hz, 25A	5600 W	
2 x 1/N/PE, 220-240V~, 50/60Hz, 25A	10200 W	
1/N/PE, 220-240V~, 50/60Hz, 25A - ZH	5600 W	
2 x 1/N/PE, 220-240V~, 50/60Hz, 25A - ZH	10200 W	
3/N/PE, 380-415V~, 50/60Hz, 16A - ZH	7900 W	
Water pressure and flow		
2.5 - 4 bars (36.3 - 58 psi) If the pressure exceeds 4.5 bars (65.3 psi), it is necessary to install a pressure valve reducer.		
If the main flow rate is under 200 L/h, there is a risk of damaging the water pump.		



849 mm (33.4 in)

743 mm (29.2 in)



667 mm (26.2 in)

717 mm (28.2 in) with large drip tray

Fig. 2-13

2.3.10 E'6s/ST, E'6m/ST datasheet



E'6m/ST

Select your region:

Asia	<input checked="" type="checkbox"/>	Oceania	<input checked="" type="checkbox"/>
Central - South America	<input checked="" type="checkbox"/>	North America	<input checked="" type="checkbox"/>
Europe	<input checked="" type="checkbox"/>	Middle East	<input checked="" type="checkbox"/>

Technical data	
Brew chamber	3 x 24 g
Grinder	4 x Ceramic burrs - 64 mm
User Interface	3 x Touch screen 256 mm (10.1")
Bean hopper	4 x 1.5 kg
Coffee outlet height*	190 mm max.
Hot water outlet height*	160 mm max. or 215 mm max. (option)
Interface	4 x USB, 2 x Ethernet, 2 x CCI/CSI
Cup heater surface	Up to 64 espresso cups
Coffee boiler size	3 x 1.5 L
Steam boiler size	5.4 L
Grounds drawer	2 x 700 g
Drip tray	Standard or Large (option)
Water Connection	
Water hose	Inox braided pipe G3/8" female x 2 m
Drain hose	Ø 22 mm x Ø 16 mm x 2 m

*measured from the drip tray

Super Traditional	E'6s	E'6m
Weight	154 kg	162 kg
Performance (up to)		
Espresso/h (23 s)	525	
Hot water/h (200 ml)	170	
Cappuccino/h (23 s)	-	350
Adjustable hot water temperature (Manual)	Yes	
Adjustable hot water temperature (Automatic)	Option	
e'Foam Micro Air Dosing (MAD) system (controlled electronically)	Yes	
Milk system with EMT (Electronic Milk Texturing)	-	Yes
Voltage / Power		
Power consumption (standby mode)	Less than 2 W	
2/PE, 208V~, 60Hz, 30A	4600 + 2300 W	
1/N/PE, 220-240V~, 50/60Hz, 25A	5600 + 2800 W	
2 x 1/N/PE, 220-240V~, 50/60Hz, 25A	10200 + 2800 W	
1/N/PE, 220-240V~, 50/60Hz, 25A - ZH	5600 + 2800 W	
2 x 1/N/PE, 220-240V~, 50/60Hz, 25A - ZH	10200 + 2800 W	
3/N/PE, 380-415V~, 50/60Hz, 16A - ZH	7900 + 2800 W	
Water pressure and flow		
2.5 - 4 bars (36.3 - 58 psi) If the pressure exceeds 4.5 bars (65.3 psi), it is necessary to install a pressure valve reducer.		
If the main flow rate is under 200 L/h, there is a risk of damaging the water pump.		



Fig. 2-14

2 Description

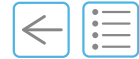

2.3.11 Shotmaster ct/Classic



Shotmaster ct/Classic

Technical data	
Brew chamber	2 x 24 g
Grinder	2 x Ceramic burrs - 64 mm
User Interface	1 x Touch screen 256 mm (10.1")
Bean hopper	2 x 1.5 kg
Coffee outlet height*	190 mm max.
Hot water outlet height*	160 mm max. or 215 mm max. (option)
Interface	2 x USB, 1 x Ethernet, 1 x CCI/CSI
Cup heater surface	-
Coffee boiler size	2 x 1.5 L
Steam boiler size	-
Grounds drawer	1 x 700 g
Drip tray	Standard
Water Connection	
Water hose	Inox braided pipe G3/8" female x 2 m
Drain hose	Ø 22 mm x Ø 16 mm x 2 m

*measured from the drip tray

Select your colour:

Earth

Tempest

Select your region:

Asia Oceania

Central - South America North America

Europe Middle East

Classic	Shotmaster ct
Weight	60 kg
Performance (up to)	
Espresso/h (23 s)	350
Hot water/h (200 ml)	170
Cappuccino/h (23 s)	-
Adjustable hot water temperature (Manual)	-
Adjustable hot water temperature (Automatic)	-
e'Foam Micro Air Dosing (MAD) system (controlled electronically)	-
Milk system with EMT (Electronic Milk Texturing)	-
Voltage / Power	
Power consumption (standby mode)	Less than 2 W
2/PE, 208V~, 60Hz, 30A	4600 W
1/N/PE, 220-240V~, 50/60Hz, 25A	5600 W
2 x 1/N/PE, 220-240V~, 50/60Hz, 25A	5600 W
1/N/PE, 220-240V~, 50/60Hz, 25A - ZH	5600 W
2 x 1/N/PE, 220-240V~, 50/60Hz, 25A - ZH	5600 W
3/N/PE, 380-415V~, 50/60Hz, 16A - ZH	5600 W
Water pressure and flow	
2.5 - 4 bars (36.3 - 58 psi) If the pressure exceeds 4.5 bars (65.3 psi), it is necessary to install a pressure valve reducer.	
If the main flow rate is under 200 L/h, there is a risk of damaging the water pump.	



280 mm (11 in)



743 mm (29.2 in)

600 mm (23.6 in)

Fig. 2-15

2.3.12 Shotmaster s/m/Classic



Shotmaster m/Classic

Technical data	
Brew chamber	2 x 24 g
Grinder	2 x Ceramic burrs - 64 mm
User Interface	1 x Touch screen 256 mm (10.1")
Bean hopper	2 x 1.5 kg
Coffee outlet height*	190 mm max.
Hot water outlet height*	160 mm max. or 215 mm max. (option)
Interface	2 x USB, 1 x Ethernet, 1 x CCI/CSI
Cup heater surface	Up to 64 espresso cups
Coffee boiler size	2 x 1.5 L
Steam boiler size	5.4 L
Grounds drawer	1 x 700 g
Drip tray	Large with pitcher rinsers or Standard (option) or Large (option)
Water Connection	
Water hose	Inox braided pipe G3/8" female x 2 m
Drain hose	Ø 22 mm x Ø 16 mm x 2 m

*measured from the drip tray



560 mm (22 in)

Fig. 2-16

Select your colour:

Earth

Tempest

Select your region:

Asia Oceania

Central - South America North America

Europe Middle East

Classic	Shotmaster s	Shotmaster m
Weight	91 kg	95 kg
Performance (up to)		
Espresso/h (23 s)	350	
Hot water/h (200 ml)	170	
Cappuccino/h (23 s)	-	350
Adjustable hot water temperature (Manual)	Yes	
Adjustable hot water temperature (Automatic)	Option	
e'Foam Micro Air Dosing (MAD) system (controlled electronically)	Yes	
Milk system with EMT (Electronic Milk Texturing)	-	Yes
Voltage/Power		
Power consumption (standby mode)	Less than 2 W	
2/PE, 208V~, 60Hz, 30A	4600 W	
1/N/PE, 220-240V~, 50/60Hz, 25A	5600 W	
2 x 1/N/PE, 220-240V~, 50/60Hz, 25A	10200 W	
1/N/PE, 220-240V~, 50/60Hz, 25A - ZH	5600 W	
2 x 1/N/PE, 220-240V~, 50/60Hz, 25A - ZH	10200 W	
3/N/PE, 380-415V~, 50/60Hz, 16A - ZH	7900 W	
Water pressure and flow		
2.5 - 4 bars (36.3 - 58 psi) If the pressure exceeds 4.5 bars (65.3 psi), it is necessary to install a pressure valve reducer.		
If the main flow rate is under 200 L/h, there is a risk of damaging the water pump.		



743 mm (29.2 in)

600 mm (23.6 in)

650 mm (25.6 in) with large drip tray

2 Description

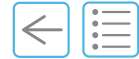

2.3.13 Shotmaster ct/ST



Shotmaster ct/ST

Select your region:

Asia	<input checked="" type="checkbox"/>	Oceania	<input checked="" type="checkbox"/>
Central - South America	<input checked="" type="checkbox"/>	North America	<input checked="" type="checkbox"/>
Europe	<input checked="" type="checkbox"/>	Middle East	<input checked="" type="checkbox"/>

Technical data	
Brew chamber	2 x 24 g
Grinder	2 x Ceramic burrs - 64 mm
User Interface	1 x Touch screen 256 mm (10.1")
Bean hopper	2 x 1.5 kg
Coffee outlet height*	190 mm max.
Hot water outlet height*	160 mm max. or 215 mm max. (option)
Interface	2 x USB, 1 x Ethernet, 1 x CCI/CSI
Cup heater surface	-
Coffee boiler size	2 x 1.5 L
Steam boiler size	-
Grounds drawer	1 x 700 g
Drip tray	Standard
Water Connection	
Water hose	Inox braided pipe G3/8" female x 2 m
Drain hose	Ø 22 mm x Ø 16 mm x 2 m

*measured from the drip tray

Super Traditional	Shotmaster ct
Weight	66 kg
Performance (up to)	
Espresso/h (23 s)	350
Hot water/h (200 ml)	170
Cappuccino/h (23 s)	-
Adjustable hot water temperature (Manual)	-
Adjustable hot water temperature (Automatic)	-
eFoam Micro Air Dosing (MAD) system (controlled electronically)	-
Milk system with EMT (Electronic Milk Texturing)	-
Voltage / Power	
Power consumption (standby mode)	Less than 2 W
2/PE, 208V~, 60Hz, 30A	4600 W
1/N/PE, 220-240V~, 50/60Hz, 25A	5600 W
2 x 1/N/PE, 220-240V~, 50/60Hz, 25A	5600 W
1/N/PE, 220-240V~, 50/60Hz, 25A - ZH	5600 W
2 x 1/N/PE, 220-240V~, 50/60Hz, 25A - ZH	5600 W
3/N/PE, 380-415V~, 50/60Hz, 16A - ZH	5600 W
Water pressure and flow	
2.5 - 4 bars (36.3 - 58 psi) If the pressure exceeds 4.5 bars (65.3 psi), it is necessary to install a pressure valve reducer.	
If the main flow rate is under 200 L/h, there is a risk of damaging the water pump.	

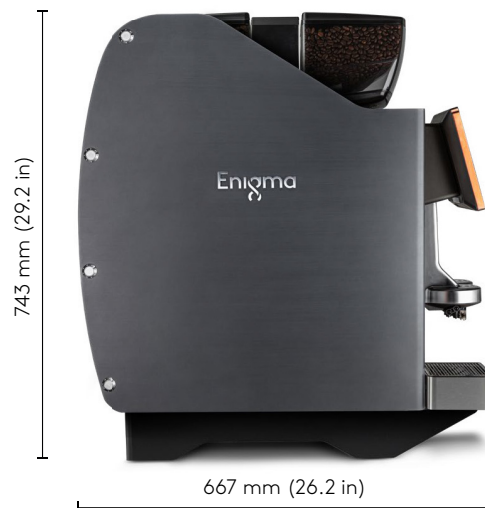

Fig. 2-17



2.3.14 Shotmaster s/m/ST



Shotmaster m/ST

Technical data	
Brew chamber	2 x 24 g
Grinder	2 x Ceramic burrs - 64 mm
User Interface	1 x Touch screen 256 mm (10.1")
Bean hopper	2 x 1.5 kg
Coffee outlet height*	190 mm max.
Hot water outlet height*	160 mm max. or 215 mm max. (option)
Interface	2 x USB, 1 x Ethernet, 1 x CCI/CSI
Cup heater surface	Up to 64 espresso cups
Coffee boiler size	2 x 1.5 L
Steam boiler size	5.4 L
Grounds drawer	1 x 700 g
Drip tray	Large with pitcher rinsers or Standard (option) or Large (option)
Water Connection	
Water hose	Inox braided pipe G3/8" female x 2 m
Drain hose	Ø 22 mm x Ø 16 mm x 2 m

*measured from the drip tray

Select your region:

Asia	<input checked="" type="checkbox"/>	Oceania	<input checked="" type="checkbox"/>
Central - South America	<input checked="" type="checkbox"/>	North America	<input checked="" type="checkbox"/>
Europe	<input checked="" type="checkbox"/>	Middle East	<input checked="" type="checkbox"/>

Super Traditional	Shotmaster s	Shotmaster m
Weight	101 kg	105 kg
Performance (up to)		
Espresso/h (23 s)	350	
Hot water/h (200 ml)	170	
Cappuccino/h (23 s)	-	350
Adjustable hot water temperature (Manual)	Yes	
Adjustable hot water temperature (Automatic)	Option	
e'Foam Micro Air Dosing (MAD) system (controlled electronically)	Yes	
Milk system with EMT (Electronic Milk Texturing)	-	Yes
Voltage / Power		
Power consumption (standby mode)	Less than 2 W	
2/PE, 208V~, 60Hz, 30A	4600 W	
1/N/PE, 220-240V~, 50/60Hz, 25A	5600 W	
2 x 1/N/PE, 220-240V~, 50/60Hz, 25A	10200 W	
1/N/PE, 220-240V~, 50/60Hz, 25A - ZH	5600 W	
2 x 1/N/PE, 220-240V~, 50/60Hz, 25A - ZH	10200 W	
3/N/PE, 380-415V~, 50/60Hz, 16A - ZH	7900 W	
Water pressure and flow		
2.5 - 4 bars (36.3 - 58 psi) If the pressure exceeds 4.5 bars (65.3 psi), it is necessary to install a pressure valve reducer.		
If the main flow rate is under 200 L/h, there is a risk of damaging the water pump.		



Fig. 2-18

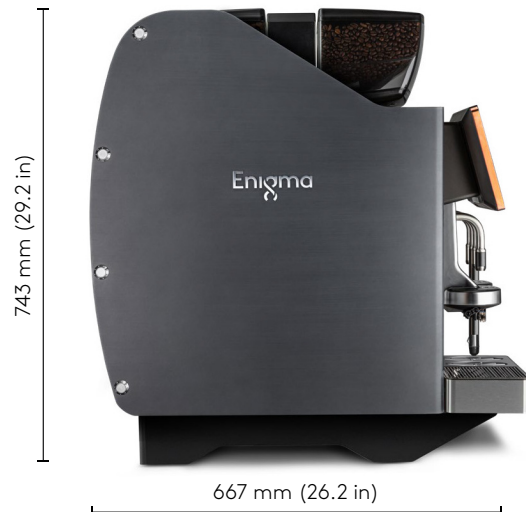

2 Description

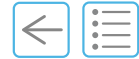

2.3.15 Shotmaster s-pro/m-pro/ST



Shotmaster m-pro/ST

Select your region:

Asia	<input checked="" type="checkbox"/>	Oceania	<input checked="" type="checkbox"/>
Central - South America	<input checked="" type="checkbox"/>	North America	<input checked="" type="checkbox"/>
Europe	<input checked="" type="checkbox"/>	Middle East	<input checked="" type="checkbox"/>

Technical data	
Brew chamber	4 x 24 g
Grinder	4 x Ceramic burrs - 64 mm
User Interface	3 x Touch screen 256 mm (10.1")
Bean hopper	4 x 1.5 kg
Coffee outlet height*	190 mm max.
Hot water outlet height*	160 mm max. or 215 mm max. (option)
Interface	4 x USB, 2 x Ethernet, 2 x CCI/CSI
Cup heater surface	Up to 64 espresso cups
Coffee boiler size	4 x 1.5 L
Steam boiler size	5.4 L
Grounds drawer	2 x 700 g
Drip tray	Large with pitcher rinsers or Standard (option) or Large (option)
Water Connection	
Water hose	Inox braided pipe G3/8" female x 2 m
Drain hose	Ø 22 mm x Ø 16 mm x 2 m

*measured from the drip tray

Super Traditional	Shotmaster s-pro	Shotmaster m-pro
Weight	163 kg	167 kg
Performance (up to)		
Espresso/h (23 s)	700	
Hot water/h (200 ml)	170	
Cappuccino/h (23 s)**	-	350
Adjustable hot water temperature (Manual)	Yes	
Adjustable hot water temperature (Automatic)	Option	
e'Foam Micro Air Dosing (MAD) system (controlled electronically)	Yes	
Milk system with EMT (Electronic Milk Texturing)	-	Yes
Voltage / Power		
Power consumption (standby mode)	Less than 2 W	
2/PE, 208V~, 60Hz, 30A	4600 + 4600 W	
1/N/PE, 220-240V~, 50/60Hz, 25A	5600 + 5600 W	
2 x 1/N/PE, 220-240V~, 50/60Hz, 25A	10200 + 5600 W	
1/N/PE, 220-240V~, 50/60Hz, 25A - ZH	5600 + 5600 W	
2 x 1/N/PE, 220-240V~, 50/60Hz, 25A - ZH	10200 + 5600 W	
3/N/PE, 380-415V~, 50/60Hz, 16A - ZH	7900 + 5600 W	
Water pressure and flow		
2.5 - 4 bars (36.3 - 58 psi) If the pressure exceeds 4.5 bars (65.3 psi), it is necessary to install a pressure valve reducer.		
If the main flow rate is under 200 L/h, there is a risk of damaging the water pump.		

**milk is coming through the 1.5-Step



Fig. 2-19

2.3.16 Rating plate

The rating plate is located beneath the drip tray.

Please copy the following information from the identification label in the fields below:

Type

Serial number (SN)

S/N: SNTTEST00 01234 56789		
Machine Type	: E4-2020 (Commercial Coffee Maker)	
Manufacture Date	: 46/20 (ww/yy)	
Voltage (main)	: 3/N/PE, 380-415V~, 50/60Hz	
Power (main)	: 7900W (5x1.5mm ²), 16A (fuse)	
Voltage (secondary)	: -	
Power (secondary)	: -	
	Coffee	Steam
Water capacity	: 2x1.5l	5.4l
Max. operating pressure	: 1.0MPa	0.2MPa
Water inlet pressure	: 0.1-0.4MPa	
<small>Eversys S.A. Ecoparc de Daval A2 3960 Sierre Switzerland Tel.: +41 (0)27 3052121 / www.eversys.com</small>		
<small>Made in Switzerland</small>		

Fig. 2-20

Symbol	Description
	Manufacturer's reference (order number)
	Serial number
	Date of manufacture (week + year)
	Manufacturer
	Machine type See "2.3.17" on page 40
	CE mark

2.3.17 Machine type correspondence table

Enigma/Classic

Machine name	Machine type
Enigma E'2ct/Classic	E2ct-2020
Enigma E'2s/Classic	E2-2020
Enigma E'2m/Classic	E2-2020
Enigma E'4s/Classic	E4-2020
Enigma E'4m/Classic	E4-2020
Enigma E'4s x-wide/Classic	E4xw-2020
Enigma E'4m x-wide/Classic	E4xw-2020
Enigma E'6s/Classic	E6-2020
Enigma E'6m/Classic	E6-2020

Enigma/Super Traditional

Machine name	Machine type
Enigma E'2ct/ST	E2ct-2021
Enigma E'2s/ST	E2-2021
Enigma E'2m/ST	E2-2021
Enigma E'4s/ST	E4-2021
Enigma E'4m/ST	E4-2021
Enigma E'4s x-wide/ST	E4xw-2021
Enigma E'4m x-wide/ST	E4xw-2021
Enigma E'6s/ST	E6-2021
Enigma E'6m/ST	E6-2021

Shotmaster/Classic

Machine name	Machine type
Shotmaster ct/Classic	SMct-2020
Shotmaster s/Classic	SM-2020
Shotmaster m/Classic	SM-2020

Shotmaster/Super Traditional

Machine name	Machine type
Shotmaster ct/ST	SMct-2021
Shotmaster s/ST	SM-2021
Shotmaster m/ST	SM-2021
Shotmaster s-pro/ST	SM Pro-2021
Shotmaster m-pro/ST	SM Pro-2021



2.4 e'Connect (Telemetry)

This leading-edge telemetry system allows you to track and process live data from anywhere in the world, to control consistency and performance, ensuring transparency, optimise service maintenance and generate statistics. It is possible to provide dashboards to enable you to converge data into simple reporting.

Specific user rights are necessary to access the telemetry system.

[Contact your service organisation for more information.](#)

2.5 Process flow

Depending on the process/product, the system will take suitable quantities of beans and grind them according to the product needs, supply them to the appropriate brew chamber and tamp according to settings. It will then brew and dispense the product according to your request.

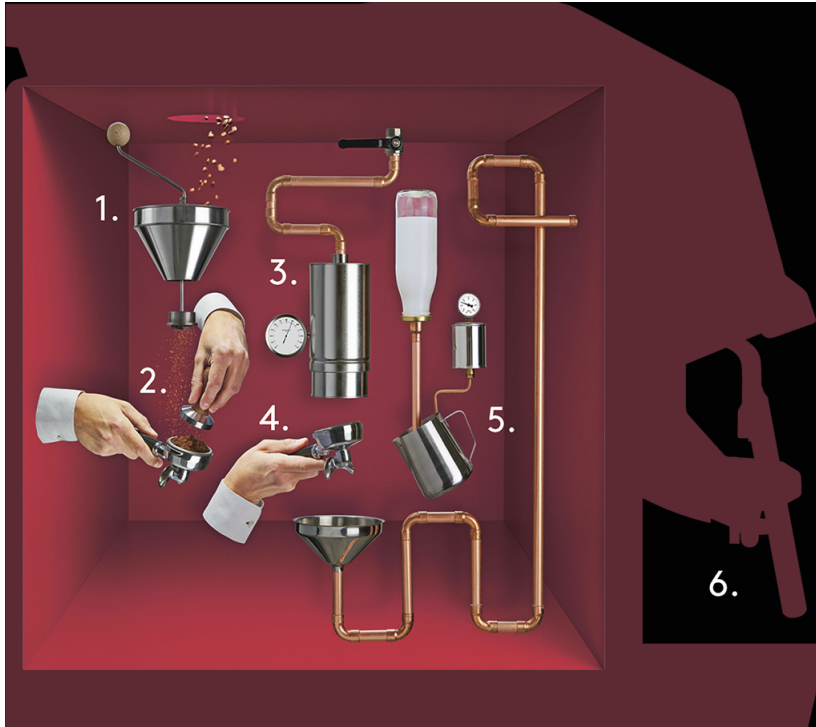

Fig. 2-21

- (1) Grinding**
Eversys - designed ceramic blades driven by a powerful yet quiet motor, whose heat is cleverly channelled away from the coffee beans, to maintain their quality, via a set of fans. Electronic control maintains consistency of product throughout the day, ensuring optimal extraction at all times.
- (2) e'Levelling and tamping**
Automatic levelling is the ability to initiate a movement to the brew chamber, create a vibration which enables the powder in the chamber to spread more evenly, which leads to a better, more consistent extraction. This movement is a replica of what the Barista does-taps the portafilter.
Tamping a 24 gram brewing chamber to facilitate single cycle large beverages is controlled by electronic tamping to guarantee consistent quality.
- (3) Temperature control**
A dedicated coffee boiler, separated from the water/steam boiler, ensures productivity and temperature control, essential parts of in-cup quality.
- (4) Brewing**
Reverse gravity extraction vertical infusion optimises powder efficiency as the espresso is produced.
- (5) Milk frothing**
Milk is frothed with steam and air in the one-step system, promoting flavour as well as texture, mirroring the Barista experience.
- (6) Dispensing**
All products are pre-programmed to be dispensed in a consistent and efficient manner, placing seamless productivity and quality at the forefront of the customer experience.



2.6 Automated cleaning Process flow

Eversys coffee machines are designed to be thorough and easy to clean.

During the day, automatic rinsing of the coffee outlets and spouts and brew groups can be programmed as required. E.g. after x minutes not used or after y products.

Daily machine cleaning is also automated and takes around 10 minutes.

The cleaning of the coffee system and that of the milk system are carried out with two specially formulated cleaning agents from Eversys. For cleaning the coffee system, Eversys offers cleaning balls that can be refilled in a machine container once a month (no daily manual addition of the tablet necessary).

Process (coffee)

- (1) Start cleaning, press rinse or as desired (see ["5.3" on page 55](#)).
- (2) Empty grounds drawer (see ["5.8" on page 62](#)).
- (3) The system performs a few flush cycles.
- (4) The system distributes a cleaning ball.
- (5) The sensor detects the distribution of the cleaning ball.
- (6) Eversys cleaning ball falls through the ball channel into the brewing chamber.
- (7) The chamber fills with water - the cleaning ball is dissolved at a certain temperature for a certain time
- (8) Cleaning cycles, and wash cycles
- (9) Empty grounds drawer (hot water warning)
- (10) Cleaning finished.

Process (milk)

- (11) For machines with a milk system, the inlets of the milk hoses must be placed in a container with Eversys milk cleaner - Everclean. The machine then automatically fills the container with water and runs through an automatic cleaning process including rinsing (see ["7.3.1" on page 80](#) for more information).

Process (choco)

- (12) For machines with a choco system, the choco hoses and outlet are automatically rinsed with hot water during automatic cleaning process.
- (13) Some parts require cleaning under a water tap on a daily (during automatic cleaning) or weekly basis. (see ["9.4.4" on page 108](#) for more information).



PAGE INTENTIONALLY LEFT BLANK

Software 3

Chapter Overview

This chapter describes the software at a glance.

3.1 Using the touch screen

The Enigma software is operated with a touch screen.

- Press to click.
- Press top (to open the top layer).
- Press and hold to open login or e.g. start automatic cleaning.
- Slide to adjust settings.



Only use your fingers to select a product/press the touch screen.

3.2 Main screen

The main screen offers access to most of the software functions and coffee products.

- The display of products and buttons depends on the settings.
A blinking button indicates that the user needs to perform an action.

The main screen may also display 15 buttons.



Fig. 3-1

- (1) Product buttons (See "3.3" on page 48)
- (2) Product stop button (See "5.7" on page 61)
- (3) Header strip or top layer (See page 47)
- (4) Rinse button (See "5.3" on page 55)
- (5) Footer strip (See page 47)

3.2.1 Header strip

The header strip is always visible except when the rinse top layer is displayed (see "5.3" on page 55).

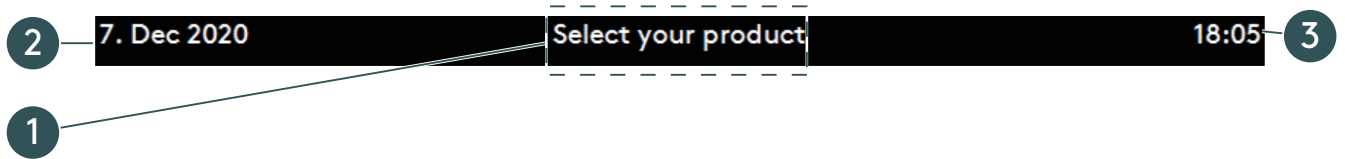

Fig. 3-2Header strip

- (1) Login access area (long press to open: See "6.1" on page 66) or press to open the top layer "3.2.2" on page 47
- (2) Date (day, month and year)
- (3) Time



To change the language, time zone and date, please refer to "11.3.3 Display" on page 126.

3.2.2 Top layer



Fig. 3-3Top layer

- (1) Info menu
- (2) Clean the screen button (See "7.3.5" on page 87)
- (3) Login access area See "6.1" on page 66
- (4) Rinse button (See "5.3" on page 55)

3.2.3 Footer strip

The footer strip is always visible and buttons differ according to settings.



Fig. 3-4Footer strip

- (1) Decaf. button (See "5.6.6" on page 60)
- (2) Milk two button (press to select milk two)
- (3) Extraction time (seconds)
- (4) Warning message (See "8.1" on page 91)
- (5) Grinder button (See "3.4" on page 49)
- (6) Purge button (See "5.6.5" on page 59)
- (7) Product layer page # (press to access other products)

3.3 Product buttons (default)

Product	Description	Product	Description
	Ristretto		Latte
	2 x Espresso		Cappuccino
	Coffee		Milkfoam
	Coffee powder - Decaf. (special product)		Espresso Macchiato
	Americano		Latte Macchiato
	Coffee Pot		Milk
	Filter Coffee		Manual Steam
	Hot Water		Auto Steam
	Choco		Everfoam™
			1.5-Step

3.4 Grinder button



Display of this button or password access depends on the settings. Default settings are limited to Service Engineer login ([see "11.3.3" on page 126](#)).

The grinder button opens the **Grinder Adjustment** menu.



Grinder adjustment tips: [See "6.6 Beans & Grinder" on page 72](#).

3.5 Specific settings

Settings are done by the Eversys service organisation. If wishing to change factory parameters, make sure to go through the ["11.3 User rights" on page 124](#) with your service engineer during commissioning.



PAGE INTENTIONALLY LEFT BLANK

Commissioning 4

Chapter Overview

This chapter outlines the initial setup of the machine.

4.1 Initial commissioning



It is imperative to read the [“1.4 General safety instructions”](#) on page 11 and understand this manual before commissioning the machine.

Specifications for the electrical connection and the standards quoted apply for connecting the coffee machine in EU countries. It may be necessary to also observe additional country-specific regulations. Outside the EU, acceptance of the standards quoted is to be checked by the legal entity or person who wishes to use the coffee machine.



The machine weighs > 50 kg, two people are required to unpack, transport and/or lift it onto a flat stable table capable of bearing its weight.

If using a forklift, hand stacker or any other manual lifting equipment, make sure to use it according to local regulations.



Your service organisation will put your coffee machine in operation for the first time and instruct you on its operation.

Subsequent recommissioning, decommissioning or any service and repair operations will also be undertaken by your service organisation.

4.2 Requirements prior to initial commissioning

A few preparations are necessary before your service engineer can set up your Enigma. The following preparations must be carried out by a professionally qualified person.

Description	OK	Issue
Flat and clean surface	<input type="checkbox"/>	
Clean environment	<input type="checkbox"/>	
Space above min. 300 mm (11.8 in)	<input type="checkbox"/>	
Stable table capable of bearing < 100 kg E'6m < 150 kg	<input type="checkbox"/>	
Table height 800 mm (31.5 in)	<input type="checkbox"/>	
Countertop cutout, see "9.2.2" on page 103 .	<input type="checkbox"/>	
Separate electrical lines for each machine.	<input type="checkbox"/>	
Electrical mains protected by RCD or RCCB	<input type="checkbox"/>	
Water mains shutoff valve with a non-return valve (type EA or according to local regulation)	<input type="checkbox"/>	
Descaling cartridge or carbon filter as minimum	<input type="checkbox"/>	
Water pressure 2.5 - 4 bars (32.3 - 58 psi) (250 - 400 KPa)	<input type="checkbox"/>	
Pressure reducer (only if pressure is above 4.5 bars)	<input type="checkbox"/>	
Flow rate above 200 L/h (Enigma, E'line) Flow rate above 140 L/h (Cameo)	<input type="checkbox"/>	
Water inlet 3/8" (AU and JA G 1/2)	<input type="checkbox"/>	
The drain hose must be connected to a siphon (input min. Ø 56 mm (Ø 2.2 in).	<input type="checkbox"/>	
Siphon input min. Ø 56 mm (Ø 2.2 in) according to EN 61770.	<input type="checkbox"/>	
Machine installed with adequate back flow protection to comply with applicable federal, state or local plumbing codes.	<input type="checkbox"/>	
Total hardness: 5 - 8° dGH (89-142 ppm)	<input type="checkbox"/>	
Carbonate hardness: Max. 6° dKH (107 ppm)	<input type="checkbox"/>	
pH value: ideal 7.0 - 7.2	<input type="checkbox"/>	
Chlorine (Cl) max. 0.1 mg/l	<input type="checkbox"/>	

Operation 5

Chapter Overview

This chapter presents how to start, stop and operate the Enigma.



It is imperative to read the [“1.4 General safety instructions”](#) on page 11 and understand this manual before making drinks with this Enigma. In case of unclear information, please contact your local service organisation.



The quality of the coffee depends on many factors, but it is most important of all to use fresh coffee beans and to regularly clean and service your machine according to [“7.1 Cleaning and maintenance operations”](#) on page 76.

5.1 Daily setup guidelines

	Procedure	See chapter
A.	Switch on.	“5.2” on page 54
B.	Or wake up with the standby button.	“5.2.1” on page 54
C.	If necessary, acknowledge errors.	“8.1” on page 91
D.	Press Rinse to Initialise startup.	“5.3” on page 55
E.	Empty the grounds drawer.	“5.8” on page 62
F.	Fill with fresh coffee bean.	“5.4” on page 56
G.	If necessary, fill with Eversys cleaning balls™.	“7.3.7” on page 89
H.	Enjoy your drink!	“5.6” on page 57

5 Operation



5.2 Switch on

- A. Move the coffee outlet (1) all the up and remove the grounds drawer (2).
- B. Start the machine at the main power (3), switch to «1» (ON).
- C. Lift the steam wand (4) and the drip tray (5).
- D. Check that the main water inlet tap is open (6).
- E. Replace the grounds drawer and push the drip tray back to its original position.

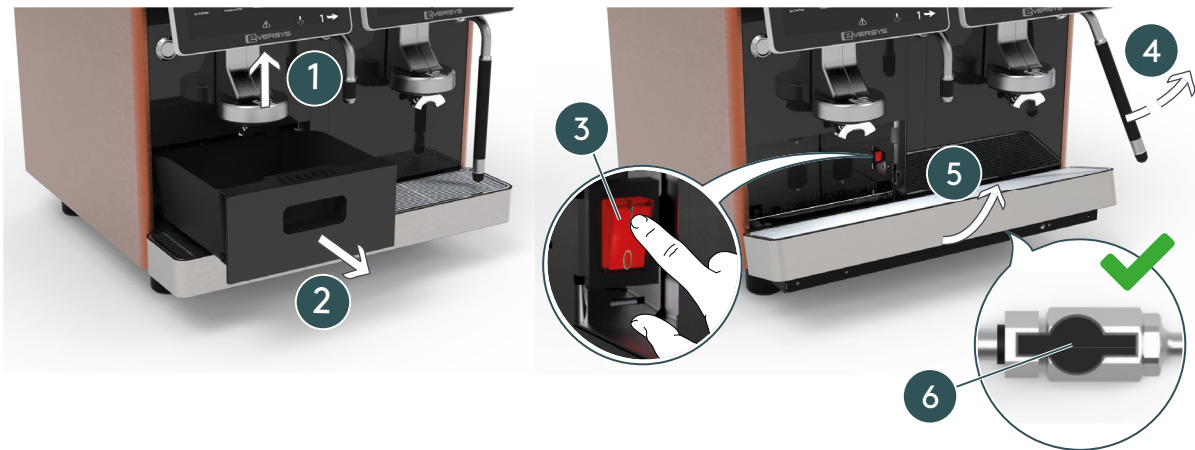

Fig. 5-1

5.2.1 Standby (wake up)



- A. If the Enigma is already switched on and in standby mode, press and hold (3s) the standby button (1) to power up.



Fig. 5-2



Standby mode switches off all the functions like heating the boiler, the touch screen and the front lighting to save energy. It is possible to use this function to switch off, for instance overnight.

5.3 Rinse



To Initialise the Enigma, it is necessary to rinse after each startup. Each time a rinse is necessary this button will flash.

- A. It is possible to rinse at any time by pressing the **Rinse (1)** button.



The Rinse button dispenses hot water.



Depending on settings, the **Rinse** button will display either in the products area or on the top layer. Refer to chapter **"11.3 User rights"** on page 124 for more information.

Top layer example:

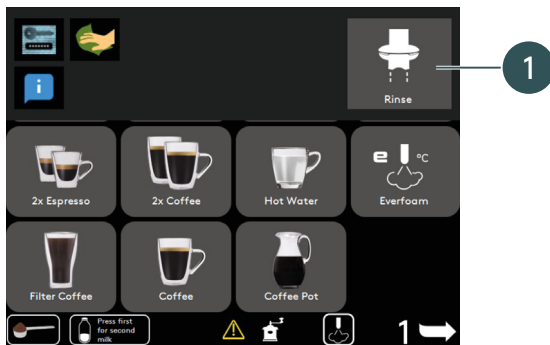

Fig. 5-3

5.3.1 Pre-heat rinse



After 10 min. idle mode (no drink is being made), a pre-heat rinse is requested by the machine if this function is activated.



To activate or deactivate this function, please contact your local service organisation.

5.3.2 Auto-rinse

Rinsing is not a substitute for daily cleaning! Auto-rinsing is necessary to remove residue build-up in the coffee and milk systems.

The Enigma automatically rinses after certain time intervals as well as when it is switched ON or OFF.

5.4 Fill the coffee bean hoppers

 **Never try to reach into the grinder. Grinder burrs are sharp and may cause injury.**

 Only open bags of coffee beans with as much as you need for the day. Store coffee beans in a cool and dry place.

Ensure that no foreign object get into the bean hopper(s). The grinder may be blocked or damaged.

The following procedures describe how to fill the bean hoppers (3).

- A. Remove the bean hopper lids (1).
- B. Ensure the bean hoppers are open (locked) (2).

 When unlocked the bean hopper is loose, and it will not be possible to grind coffee (closed position).

- C. Fill with fresh coffee beans (3).
- D. Close the lids (4).

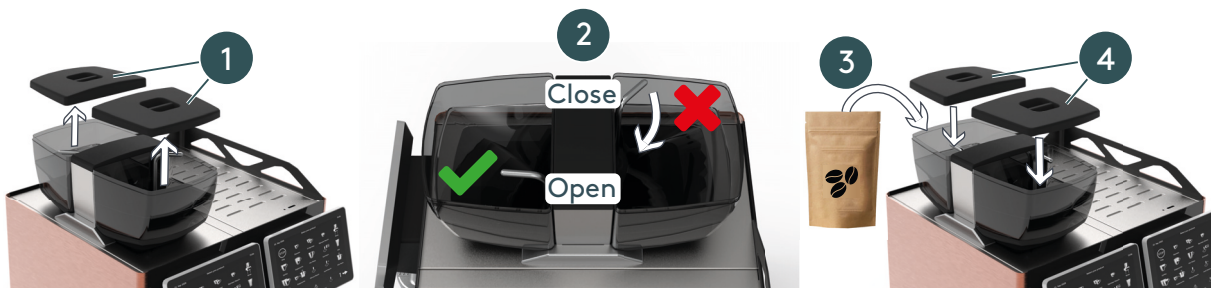

Fig. 5-4

5.5 Cups heating surface

- A. Fill the heating surface with cups.

 **Be careful as the cups and the heating panel may be hot.**



Fig. 5-5

5.6 Make a drink

It is not possible to outline all drink products in this manual. You can find an overview of the main products in the following chapters.

To change settings or display of the product buttons, refer to [“11.3.3 Display” on page 126](#).



All product buttons function as start/stop buttons.

Press the button to start dispensing the product and, if necessary, to stop dispensing manually: press the same product button again.

5.6.1 Adjust the coffee outlet height

- A. Move the coffee outlet (1) up or down to adjust it according to cup height.



Max. cup height is 190 mm.



Fig. 5-6

5.6.2 Coffee product



- A. Place a cup under the coffee outlet.
- B. Press this button to make two Espressos at the same time.

5.6.3 Hot water product

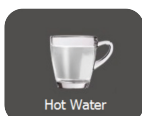

- A. Place a cup under the hot water outlet.
- B. Press this button to dispense hot water (e.g. to make a tea).

5.6.4 Steam product



- A. Before using the steam wand, press the purge button (“5.6.5” on page 59) to evacuate air from possible condensation.
- B. Place a milk frothing pitcher (1) under the steam wand.
- C. Insert the steam wand in the milk frothing pitcher (filled to one third with fresh cold milk).
- D. Press one of the steam buttons (2) to dispense a steam product (e.g. to make milk foam or coffee art (3)).

 Never leave the steam wand immersed in the pitcher if not used.

- E. Purge and wipe the steam wand (“5.6.5” on page 59).

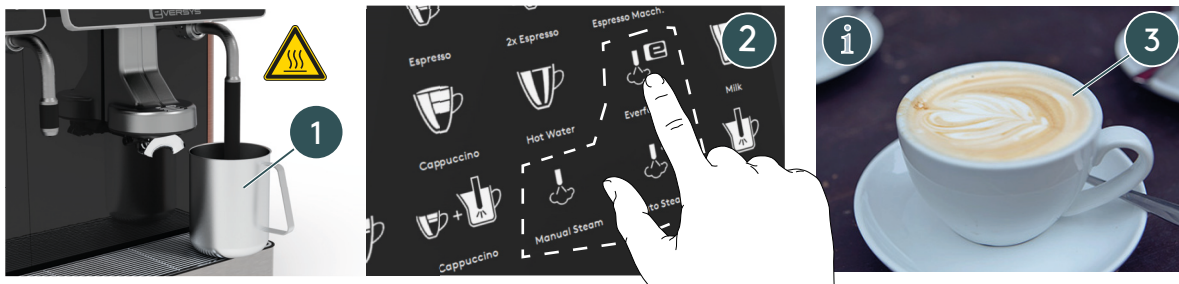

Fig. 5-7

5.6.5 Steam purge button



To initialise the Enigma, it is necessary to press the blinking purge button after each start-up. Each time a purge is necessary this button will flash.

After every use of the steam wand it is necessary to wipe and purge it.

- A. Press the blinking purge button on the main screen (1).
- B. Wipe the steam wand with a damp cloth (2). Change cloths every day.
- C. On the screen that displays, press purge (3).



Caution hot steam!

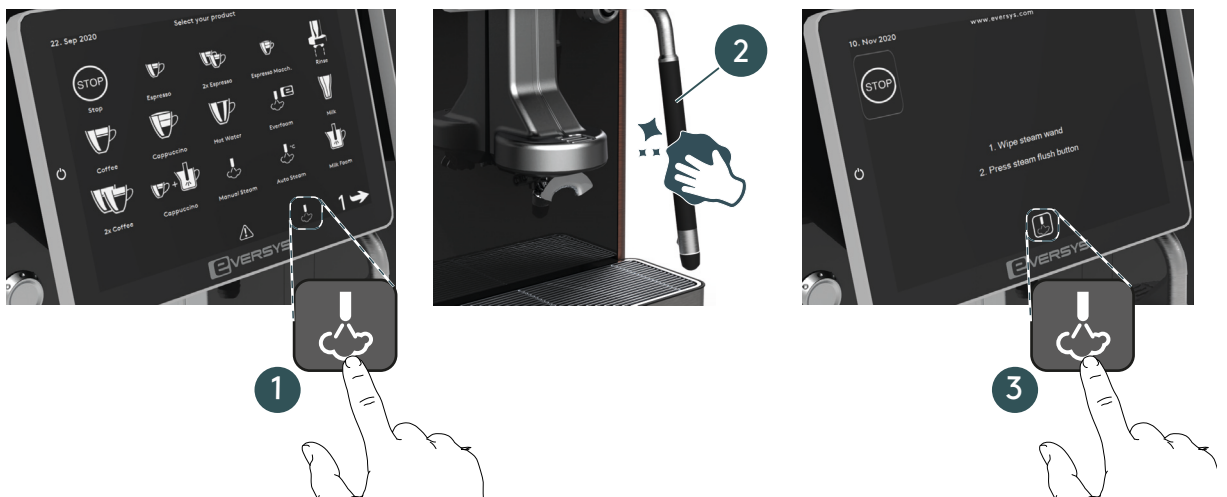

Fig. 5-8

5.6.6 Powder coffee product (decaf.) (optional)



Only add ground coffee in the decaffeinated powder chute!



Depending on settings, the **Decaf.** button may not be displayed in the products area. Refer to chapter [“11.3.3 Display” on page 126](#) for more information.

- A. Press the button with measuring scoop (1).
- B. Press the desired product (2).
- C. Open the powder chute (3) and add one portion of ground coffee max. 20 g. Use espresso fine grind coffee for optimal in-cup quality.
- D. Close the powder chute lid (3) and press **Continue** (4) to dispense the product.



Fig. 5-9

5.7 Product stop



- A.** To stop dispensing of all products, press the stop button (1).



Depending on the settings, the **STOP** button may not be displayed in the products area (2). Refer to chapter [“11.3.3 Display”](#) on page 126 for more information.



Fig. 5-10

5.8 Empty grounds drawer



RISK OF BURNS.

After first startup or during cleaning, the grounds drawer may contain hot water, empty it carefully (see "7" on page 75 for more information).



Coffee grounds may be composted or recycled with organic waste (3).

- A. Once the grounds drawer is full with coffee cakes, empty it according to the following steps and the instructions displayed.
- B. Move the coffee outlet up (1).
- C. Remove the grounds drawer (2).
- D. Empty the grounds drawer (3), clean and dry it.
- E. Replace it inside the machine.

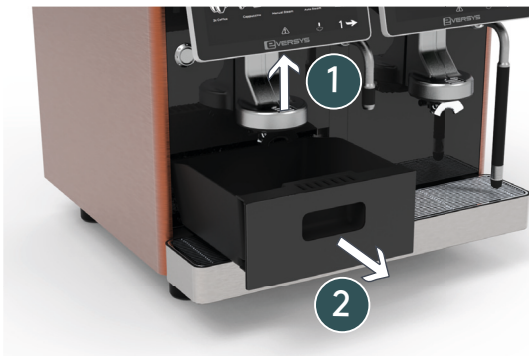
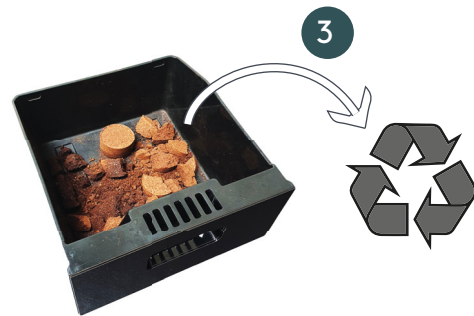

Fig. 5-11



- F. Press **Yes** to acknowledge emptying of the grounds drawer (or **No** to cancel).

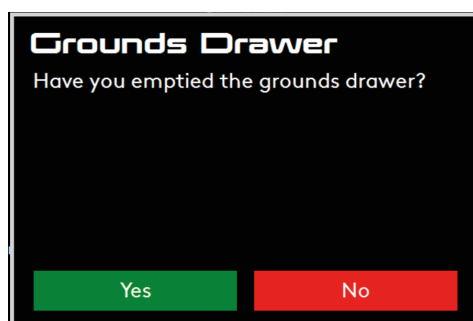

Fig. 5-12



5.9 Switch off

- A. Shut down the Enigma at the main power switch, to «0» (Off).

Refer to chapter "5.2 Switch on" on page 54 for more information.

5.10 End of the day guidelines



To avoid odors and possibly sticky coffee and milk residues (which might also block the machine), make cleaning part of your daily end-of-the-day procedure.

This will ensure top quality coffee and smooth operation.

	Procedure	See chapter
A.	Clean	"7.2" on page 78
B.	Switch off or standby	"5.9" on page 63
C.	Have a nice evening ahead!	;)

5.11 Emergency stop



Perform an emergency stop **ONLY** if the machine is completely stalled and does not respond to any command.

To shut down all functions, either:

- switch OFF at the main power switch (3).
- unplug the power cord from the mains socket.



The Enigma must be located in such a manner that the main switch and power cord are accessible at all times.

The mains power socket must be located near the Enigma and must be easily accessible by the operator.

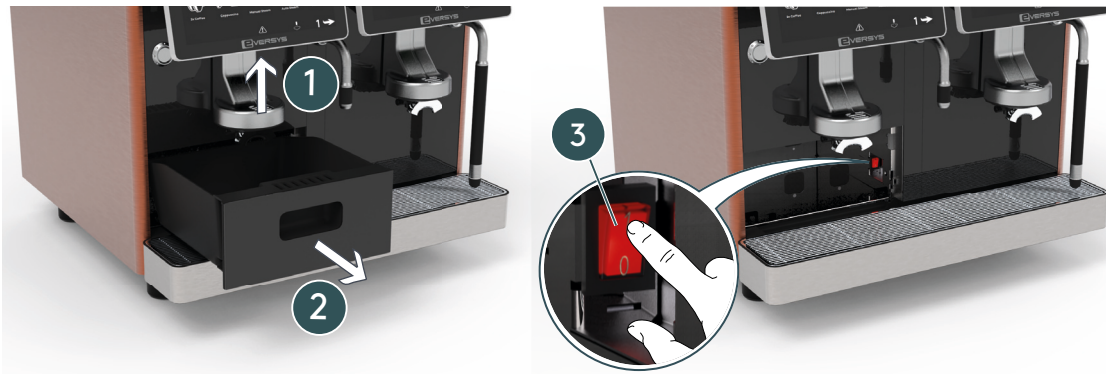

Fig. 5-13 Emergency stop

Settings Menu 6

Chapter Overview

This chapter outlines Operator and Manager basic settings.



Never give your password to untrained users. Incorrect entries or changes may reduce the quality of drinks.



The display of these chapters depends on your login level. Please refer to the Appendix, chapter [“11.3 User rights” on page 124](#) for more information.

6 Settings Menu



6.1 Login menu

- A. Press and hold the login area (see "3.2.1 Header strip" on page 47).

↳ The login menu displays.

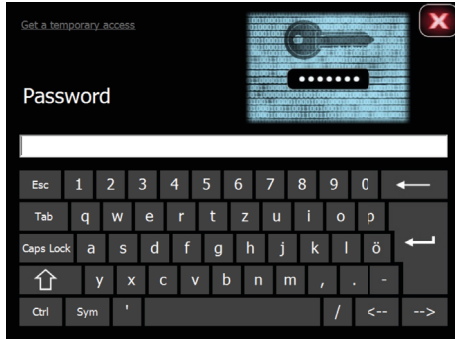

Fig. 6-1

- B. Type in your password to access the settings menu.
- C. If you do not have a password, it is possible to request a temporary password. Press **Get a temporary access** and provide your service organisation with the number displayed.

↳ The settings **Menu** displays.

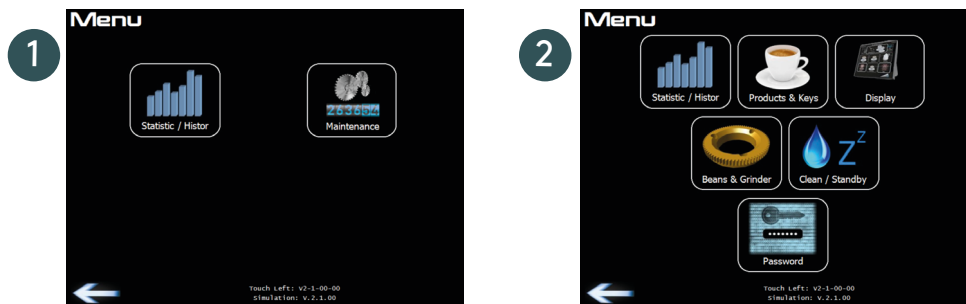

Fig. 6-2

- (1) **Menu** example with operator access.
- (2) **Menu** example with manager access.



Operator login lets you view statistics (product counter) and cleaning history.

Manager login is a limited access for product settings and display functions. Full access to all statistics and history.

6.2 Use of the software menu (Manager)



Fig. 6-3

- (1) Select a product.
- (2) Press a sub-menu to display its settings.
- (3) Slider: Slide left or right to adjust settings.
- (4) Up/down keys: Use these arrows (green) for fine adjustments.
- (5) **Product Test**, use this button to test the product and avoid going back to the main screen.
- (6) **Learn Quantity**, use this button to adjust the quantity of water or milk depending on the product.
- (7) Browse layers.
- (8) Browse menu.
- (9) Navigate to previous menu.
- (10) Reference key, sync products between the left and right screens.

6 Settings Menu



6.3 Statistic/History

This menu allows access to:

- Product Counter.

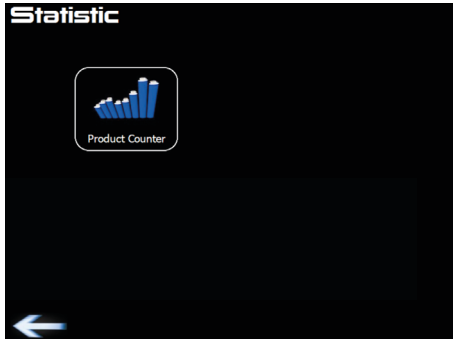

Fig. 6-4



All counters are linked to a password. It is possible to reset counters if necessary.

6.3.1 Product Counter

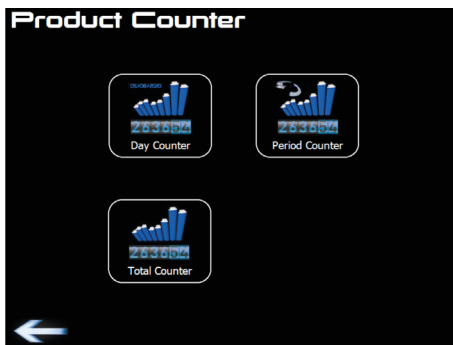

Fig. 6-5

Total counter example



Fig. 6-6

6.4 Products & Keys (Manager login)

With manager access it is possible to modify the following settings.



The hot water quantity is set in seconds when dispensed from the steam boiler and in ticks (controlled by the flowmeter) when it is dispensed from the coffee boiler.

Adjustment range is 0 to 1000 ticks. Ticks are approximately equal to ml.

The milk quantity is set in seconds. Adjustment range is 0 to 100 seconds.

- (1) **Key Name**, press to type in a new name (maximum 13 characters).
- (2) **Water Quantity**, press to modify the number of ticks or seconds (adjust with the slider or up/down keys).



Fig. 6-7

(3) Learn Quantity

- A. Press **Learn Quantity** to dispense a coffee.
- B. When the desired level is in the cup, press the same button to stop the drink.

↳ This memorises the number of ticks (or seconds).

- (4) Press **Milk sequence** or **Powder sequence** (only if you have the E'choco unit) to open available settings.
- (5) **Milk Quantity** (only for milk products), press to modify the numbers of seconds or **Learn Quantity**.
- (6) **Product test**

Ensure that at least 6 beverages are run using **Product Test** to achieve the desired coffee and extraction time and that the grinder is delivering the correct amount of coffee for the set cake thickness.

To adjust see ["6.6 Beans & Grinder" on page 72](#).

Everfoam and auto foam products

With these steam products it is possible to control the **Stop Temperature** and **Foam Texture**.

Hot water products

With hot water products it is possible to control the **Water Temperature**.

6.5 Display

With manager access it is possible to import and set a language, import new Screens and set the date, number of display layers, screensaver and front lightning.



If a required language is not available, please contact your service organisation.

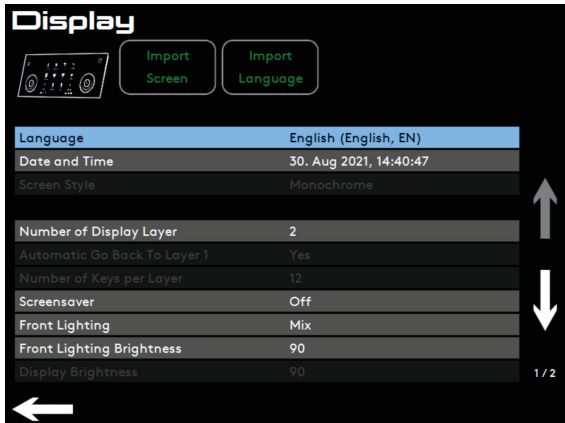

Fig. 6-8

Set time and date

Follow the screen instruction. Set time and date if needed.

Time zone

Choose time zone to get correct daylight saving time.

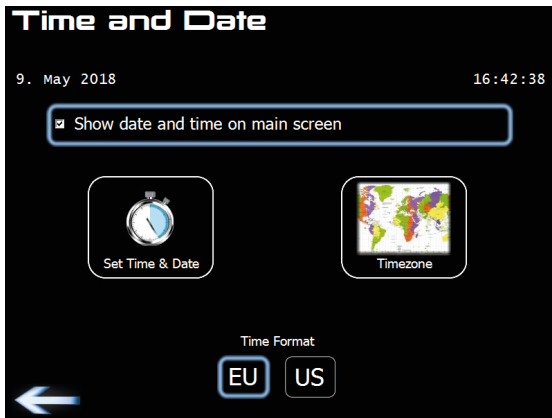

Fig. 6-9

Front lighting

- **Off** (no decorative light under front panel)
- **Select colour** (fixed colour under front panel)
- **Mix** (complete colour spectrum within 3 minutes)

Number of display layers

1 to 4 layers (up to 15 products per layer depending on settings).

Maximum 62 product keys.

6.5.1 Import Screen

Process is similar to language import, see [“6.5.2 Import Language” on page 71](#)



Store the «.screen» file in the main directory of the USB drive.

The button **Delete Screen** deletes all user defined icons.

Filetype: JPEG or PNG. Please note that the files must also respect specific conditions. Please contact your service organisation for more information.

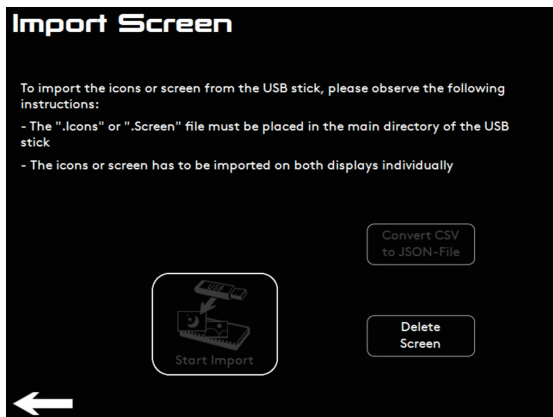

Fig. 6-10

6.5.2 Import Language

Languages can be imported by pressing **Import Language** key.

Follow the instructions displayed.



Store the «.Language» file in the main directory of the USB drive.

The button **Delete All Languages** removes all languages except for English.



Fig. 6-11

6.6 Beans & Grinder



Display of this button of this screen depends on settings. Default settings are limited to Service Engineer login (see "11.3.3" on page 126).

From the **Grinder Adjustment** menu it is possible to manually adjust the grind size of the coffee powder by 1/100 mm.

Grind hopper rear (green) or the **Grind hopper front** (blue) allow to test grinding of the coffee beans.

- A. Press **finer (-)** or **coarser (+)** to adjust the grind size.



Fig. 6-12

6.6.1 Adjustment tips



Adjust by setting the grinder either finer or coarser to increase or decrease the extraction time. Average extraction time for two espressos at 25 ml each is 21 to 23 seconds.

6.7 Clean/Standby

Standby after cleaning

- No (machine continues to work after cleaning).
- Yes (machine switches to standby mode after cleaning).

Standby On/Off times

Set the time and choose the days.

↳ The machine will automatically switch on, rinse and heat up accordingly.

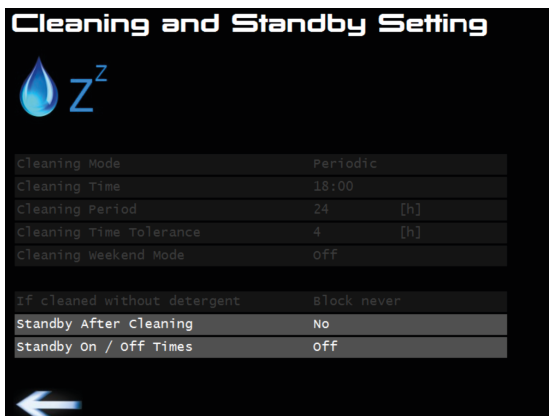

Fig. 6-13

6.8 Password

Two access levels are available. A password can be defined for each level.



Make sure to remember the passwords.

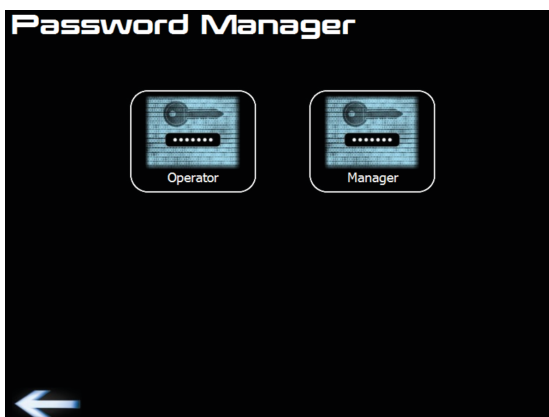

Fig. 6-14



6.9 Logout (service engineer).

If a service engineer forgot to logout, check that nobody is still working on the machine and press **Logout (1)**.

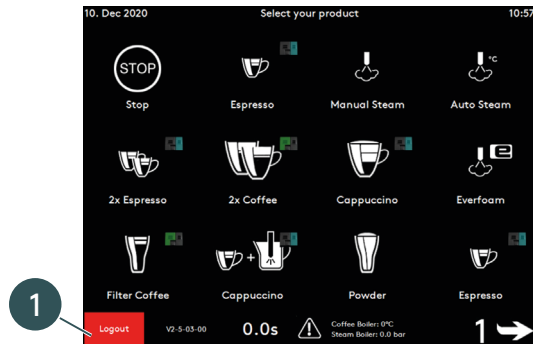

Fig. 6-15

Care 7

Chapter Overview

This chapter explains in detail how to clean and maintain your Enigma.



It is imperative to read the “1.4 General safety instructions” on page 11 and understand this manual before carrying out any cleaning on the Enigma. In case of unclear information, please contact your local service organisation.

Use only Eversys cleaning balls™ and Everclean™ solutions to clean the system.

Ensure that no one ever ingests these cleaning solutions.

If any variation of performance is observed or suspected, even after care operations, contact your local service organisation.



Do not put the Enigma or any of its component parts in the dishwasher.

Clean under tap water with soft soap.

Dry the parts well after cleaning them. There must not be any residue from cleaning agents.



7.1 Cleaning and maintenance operations

7.1.1 Cleaning

Regular cleaning is mandatory in order to ensure problem-free operation of the coffee machine and to ensure optimum coffee quality.

It is imperative to ensure that persons are not subject to any health hazards as a consequence of the consumption of the food items dispensed by the Enigma.

If care and cleaning of the coffee machine is not carried out properly, dispensing milk beverages will constitute a food hygiene hazard point.

All automatic cleaning operations are logged.

For more information on the cleaning intervals, [See chapter "7.2 Periodic cleaning" on page 78.](#)

7.1.2 Maintenance

The Enigma needs to be serviced every **12 months** or every **50'000 products** per brewing side (e.g. 50k E'2 and 100k E'4). Maintenance may only be carried out by a service organisation appointed by the manufacturer.

Please contact your local service organisation for any maintenance tasks.



Fig. 7-1

7.2 Periodic cleaning

7.2.1 Cleaning plan

Description	Daily (auto)	Weekly	Monthly	Or as required	See
Automatic system rinse	✓	✗	✗	✓	page 55
Automatic system cleaning Eversys cleaning balls™	✓	✗	✗	✓	page 80
Automatic milk system cleaning Everclean™	✓	✗	✗	✓	page 80
Steam wand	✓	✗	✗	✓	page 59
Steam wand (remove tip)	✗	✗	✓	✓	page 90
1.5-Step (optional)	✓	✗	✗	✓	page 114
Coffee/milk outlet	✗	✓	✗	✓	page 85
Bean hoppers	✗	✓	✗	✓	page 86
Housing and touch screen	✓	✗	✗	✓	page 87
Drip tray	✓	✗	✗	✓	page 88
Grounds drawer	✓	✗	✗	✓	page 84
Undercounter ground coffee disposal (optional)	✓	✗	✗	✓	page 111
Milk tank	✓	✗	✗	✓	page 83
Milk fridge	✓	✗	✗	✓	page 83
Visual inspection cleaning balls dispenser	✓	✗	✗	✓	page 89
E'choco	✓	✓	✗	✓	page 108

7.2.2 Cleaning table

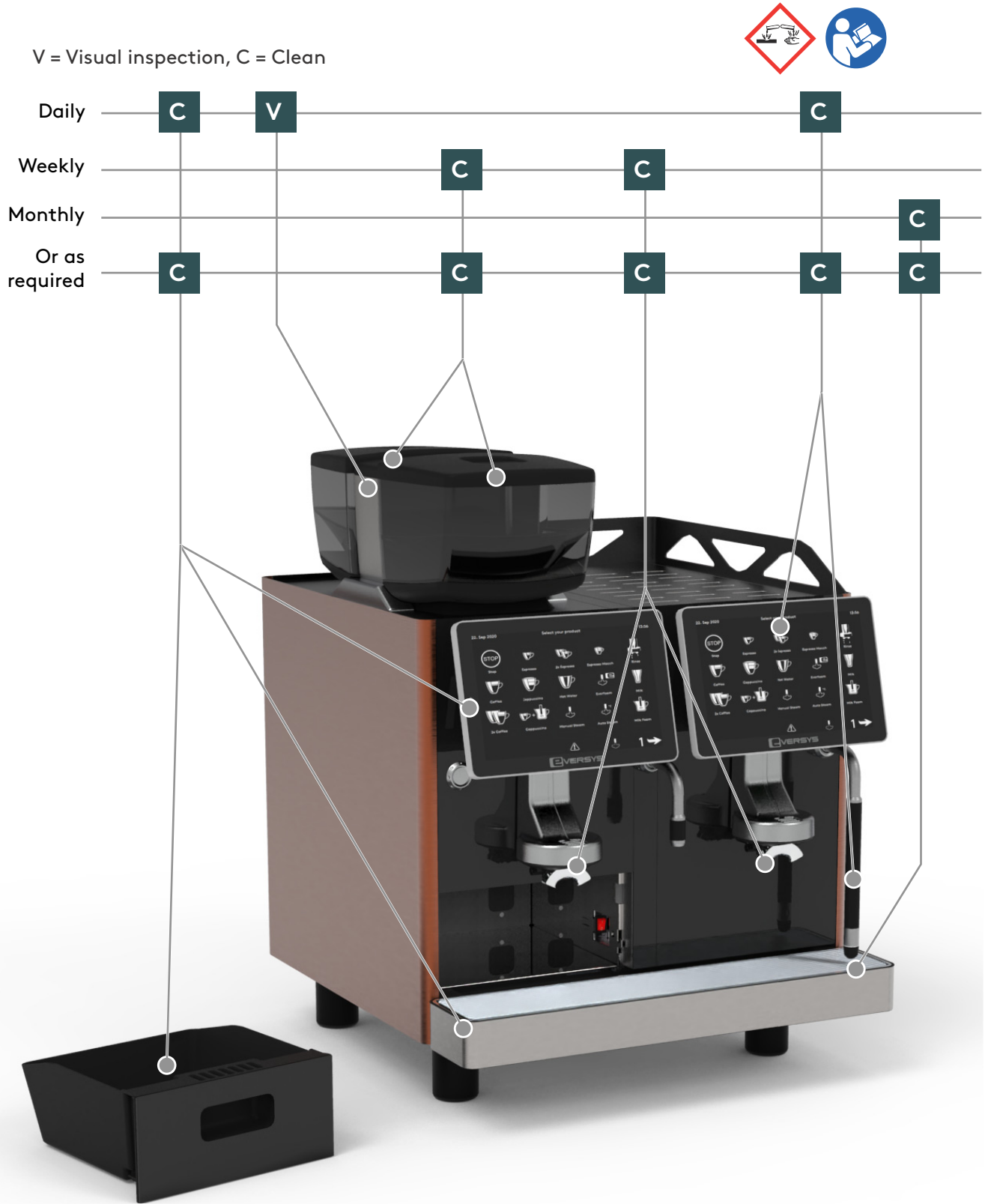

Fig. 7-2

7.3 Cleaning procedures

7.3.1 Automatic system cleaning procedure (with milk)

It is possible to run the complete cleaning procedure at any time. Though you must run the cleaning when requested (if cancelled and depending on settings, it will not be possible to make a drink unless cleaning is performed). The following procedure is illustrated with the E'fridge, the milk tank and the fridge may differ (e.g. with the Vitrefrigo® side fridge there is a high milk tank).



- A. Press and hold the rinse button for 3 s to run automatic cleaning.

↳ The **Cleaning?** menu displays.



Fig. 7-3

- B. Press **Yes** (or **No** to cancel)

↳ The **Prepare Milk Cleaning** displays.



Fig. 7-4

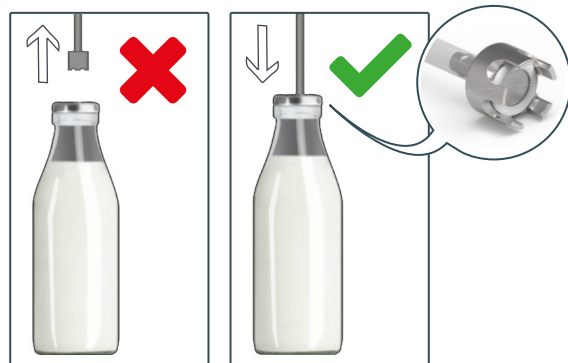

DO NOT REMOVE THE MILK TUBES FROM THE MILK TANK before requested on the screen. The milk in the tube will be pushed back.

- C. Press **Continue** to acknowledge.

↪ Pushing back milk displays for a few seconds.



Fig. 7-5

↪ The **Grounds drawer** menu displays.



Fig. 7-6

- D. Empty the grounds drawer according to chapter [“5.8 Empty grounds drawer”](#) on page 62.
- E. Press **Continue**.

↪ The **Prepare Milk Cleaning** menu displays.



Fig. 7-7

- F. Remove the milk tank (1) and store it in a fridge during the cleaning process. If necessary clean the milk tank with warm water and soft soap. Rinse thoroughly.



Fig. 7-8

If using 1 litre bottle cleaning solution

- G. Remove the correct bottle cap (2.1).
- H. Place the milk tube inside the cleaning tank (2.2). Ensure that it correctly lays at the bottom of the tank.
- I. Fill the empty cleaning tank (2.3) with 25 ml Everclean™ (1/2 full E'2m) or with 50 ml (3/4 full E'4m, E'6m).
- J. Place the cleaning tank inside of the fridge.
- K. Press **Continue (3)**.



Fig. 7-9

If using 3 litre bottle

- L. Fill the empty cleaning tank (2.1) with 25 ml Everclean™ (press the pump once for E'2m) or with 50 ml (press the pump twice for E'4m - E'6m).
- M. Place the milk tube inside the cleaning tank (2.2). Ensure that it correctly lays at the bottom of the tank.
- N. Place the cleaning tank inside of the fridge.
- O. Press **Continue (3)**.

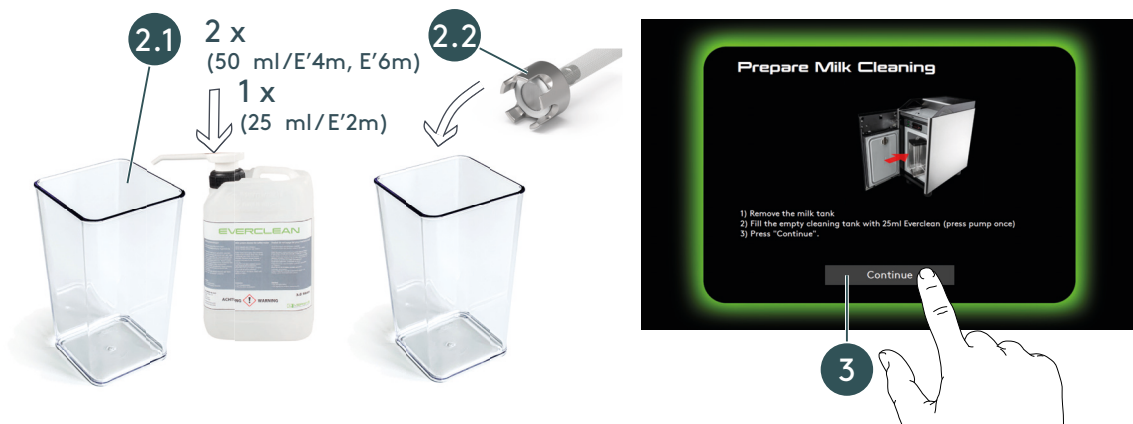

Fig. 7-10

↪ Cleaning in progress displays.

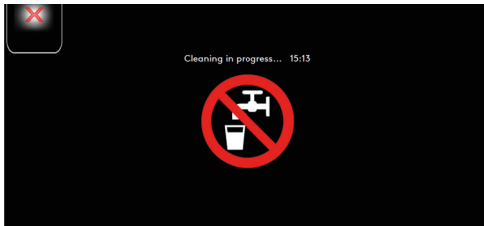

Fig. 7-11



It takes approximately 12 minutes to complete the entire process.



RISK OF SCALDING OR BURNS.

Hot cleaning solution and steam are dispensed several times during the automatic cleaning. Do not touch the outlets or the zone under the outlets.

↪ Milk cleaning container displays.

- P.** When cleaning is finished, remove and clean the cleaning tank (1).
- Q.** Empty the cleaning tank in a sink (2).
- R.** Clean the milk tank tube (3) with a damp single-use cloth and replace the milk tank in the fridge.
- S.** Ensure that milk tank tube (3) correctly lays at the bottom of the tank.
- T.** Press **Continue** (4) when done.

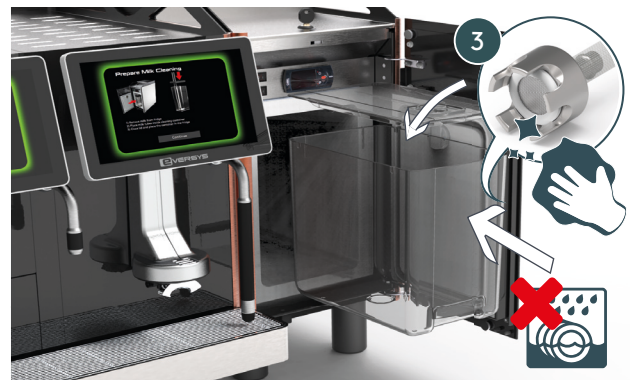

Fig. 7-12

↪ The following menu displays.



Fig. 7-13



RISK OF BURNS.

The grounds drawer contains hot water, so empty it carefully.

- U.** Empty the grounds drawer in a sink (1) and clean it with soft soap.
- V.** Rinse and dry the grounds drawer (2).
- W.** Replace the grounds drawer inside the machine (3).

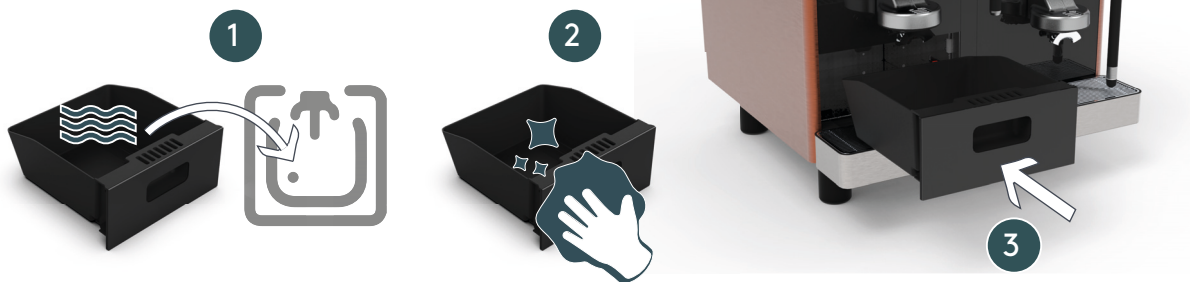

Fig. 7-14

7.3.2 Coffee/milk outlet V2 (metal)

To clean the coffee/milk outlet proceed as follows.

- A. Switch off the machine at the main switch (see “5.9 Switch off” on page 63).
- B. Gently pull down (1) to remove the coffee outlet.
- C. Clean with soft soap under clean water (3).
- D. Gently reassemble in the reverse order.

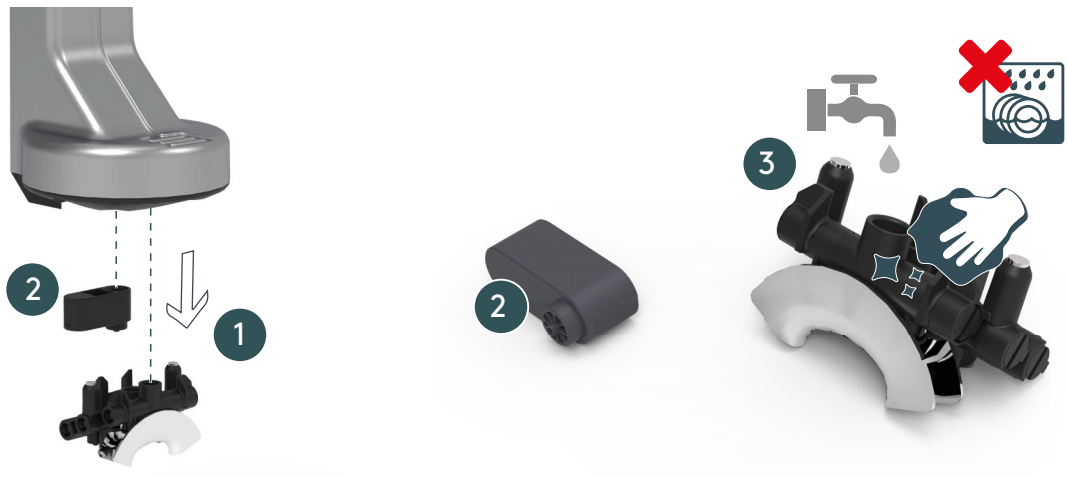

Fig. 7-15



If you have the optional E'choco module ensure to clean the choco outlet (2). See chapter “9.4 E'choco” on page 105.

7.3.3 Bean hoppers (and decaffeinated powder chute)

To clean the bean hoppers proceed as follows.

- A. Switch off the machine at the main switch (see "5.9 Switch off" on page 63).
- B. Remove both bean hopper lids (1).
- C. Unlock the bean hoppers (2).
- D. Remove the bean hoppers (3) and store the beans for re-use.
- E. Clean the bean hoppers (4) with soft soap, rinse with water and dry with a soft cloth.
- F. Make sure that the bean hoppers are perfectly dry before refilling with coffee beans.
- G. Reassemble in the reverse order and lock the bean hoppers.

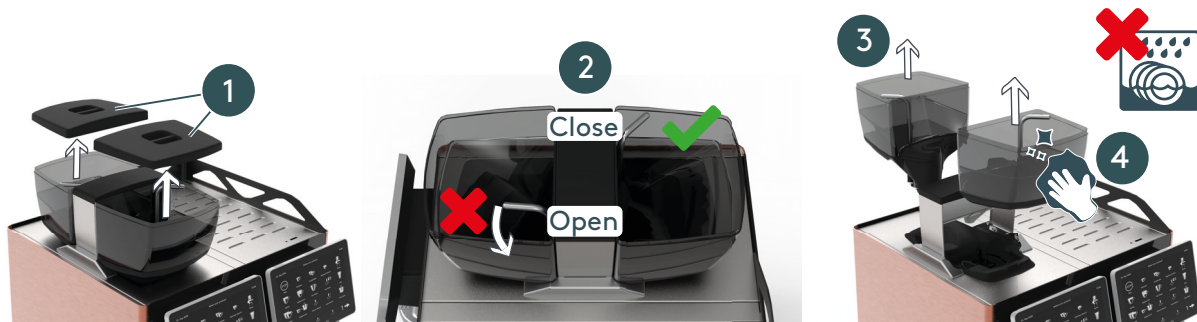

Fig. 7-16

7.3.4 Housing

- A. Switch off the machine at the main switch (see “5.9 Switch off” on page 63).
- B. Clean the housing with a damp cloth.

7.3.5 Display (touch screen) cleaning



- A. Press on the top middle of the touch screen (1).
- B. Press on the **Clean the screen** button (2).

The screen displays a countdown timer.



Fig. 7-17

- C. During the countdown, disinfect the screen according to the following recommendation ([watch video:https://wi.st/3iMX0Ve](https://wi.st/3iMX0Ve)).



Only use commercial disinfectants for hands. Do not use any sanitary disinfectants!

Spray disinfectant on a soft cloth and carefully wipe the display with the cloth.

Important! Never spray any liquid directly onto the touch screen.



The countdown allows to clean the screen without the risk of starting a product.

7.3.6 Drip tray

- A. Switch off the machine at the main switch (see “5.9 Switch off” on page 63).
- B. Remove the drip tray grid (1).
- C. Wash the grid and inside of the drip tray (2) with soft soap and rinse.
- D. When replacing the grid, make sure that it lays nice and flat.

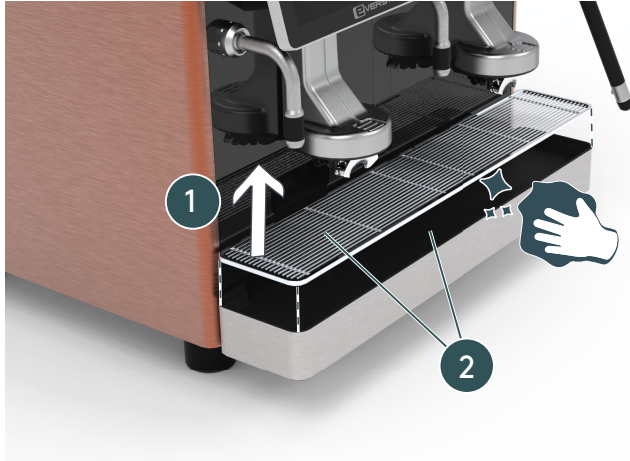

Fig. 7-18

7.3.7 Refill and visual check of the cleaning balls dispenser

- A. Switch off the machine at the main switch (see “5.9 Switch off” on page 63).
- B. Remove the lid (1) and check that there are no blocked or broken cleaning balls in the dispenser (3).



Make sure to previously switch off the machine. There is a risk of minor injury with moving parts.

- C. If necessary, clean the dispenser and remove the blocked or broken cleaning balls.
- D. Refill with Eversys cleaning balls™ (2).



Make sure that there are no broken Eversys cleaning balls™ (3).

- E. Replace the lid (1).



Fig. 7-19

7.3.8 How to clean the steam nozzle

 Only necessary to clean the nozzle monthly or if required.

- A. Switch off the machine at the main switch (see “5.9 Switch off” on page 63).
- B. Remove the nozzle (1).
- C. Ensure to not remove (2) the white seal (only on steam wand V1, this seal is not available any on steam wand V2; manufactured after May 2021).
- D. Wash the nozzle with soft soap and clean water using a soft brush (3).
- E. Tighten the nozzle (4).
- F. Check that there is no gap between the seal and the nozzle (steam wand V1) (5).

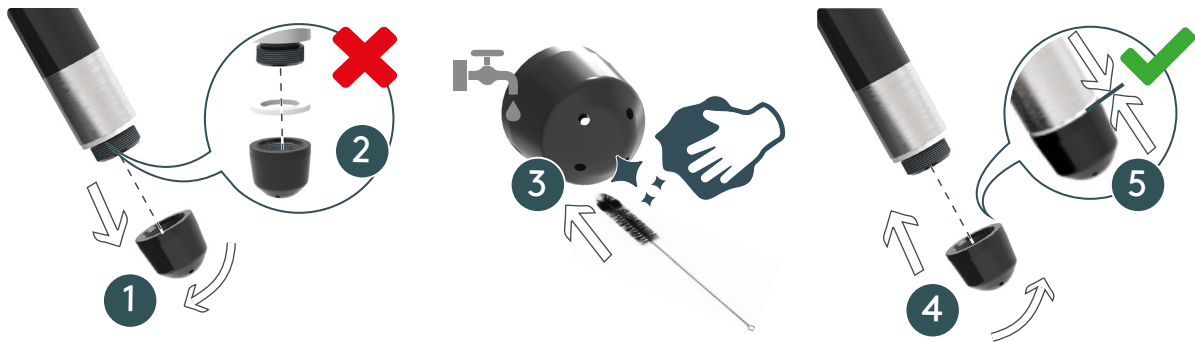

Fig. 7-20

Troubleshooting 8

Chapter Overview

This chapter covers all user interface warning messages.



It is imperative to read and understand this manual before carrying out any troubleshooting on the Enigma. In case of unclear information, please contact your local service organisation.

8.1 Error message example

All Eversys coffee machines are equipped with an internal troubleshooting and error message system. The following screen shows an example.

If an action of the user is required, the warning sign (1) is displayed.

- A. Press the warning sign (1) to display the warning message and required action.
- B. Follow the display message(s) to solve the problem and press **OK** when done.
- C. Use the arrow keys to navigate between the different warning/error messages.

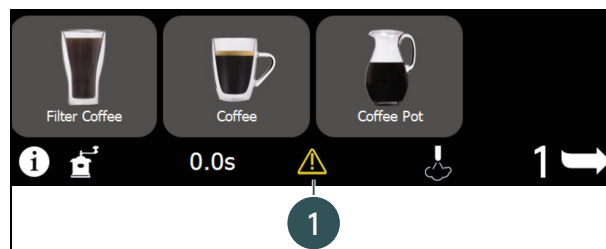

Fig. 8-1



Fig. 8-2

8.2 Error messages



If the actions listed below fail to rectify the issue or other problems not listed here occur, contact your local service organisation.

W = Warnings

S = Stops

E = Errors

#	Info message	Explanation/Corrective action	Refer to
E-000	Bean hopper front missing	Bean hopper removed during a process (e.g. during cleaning: replace the bean hopper and wait until cleaning is finished).	-
E-001	Bean hopper rear missing	Bean hopper removed during a process (e.g. during cleaning: replace the bean hopper and wait until cleaning is finished).	-
E-010	Software too old. Please start software update.	Contact service organisation.	-
E-011	Hydraulic unit not connected. Water pump has been switched off.	Contact service organisation.	-
E-012	Milk unit not connected. Water pump has been switched off.	Contact service organisation.	-
E-013	Brewing unit not connected.	Contact service organisation.	-
E-014	Grinder unit not connected.	Contact service organisation.	-
E-095	Software update running. Please wait...	Contact service organisation.	-
E-097	Please set machine type	Contact service organisation.	-
E-098	Please start software update	Contact service organisation.	-
E-099	Communication Error. Please turn the coffee machine off, wait 10 s and turn it on again.	Communication error. Please turn the coffee machine off, wait 10 s and turn it on again.	"5.2" on page 54
E-100	Pressure Sensor Always Zero	Contact service organisation.	-
E-102	Steam Boiler Empty Timeout	- Switch the machine OFF, wait 10 sec. and turn it back ON. - If doesn't work, contact service organisation.	"5.2" on page 54
E-103	Timeout during steam boiler filling. Please check the water supply and press "Continue".	- Switch the machine OFF, wait 10 sec. and turn it back ON. - If doesn't work, contact service organisation.	"5.2" on page 54
E-104	Timeout Steam Heating	- Switch the machine OFF, wait 10 sec. and turn it back ON. - If doesn't work, contact service organisation.	"5.2" on page 54
E-105	Steam boiler connector missing	Contact service organisation.	-



#	Info message	Explanation / Corrective action	Refer to
E-197	Please set machine type	Contact service organisation.	-
E-198	Please start software update	Contact service organisation.	-
E-199	Communication Error Steam	See E-099 on page 92.	-
S-000	Initialise, please wait...	Wait until the initialisation has finished	-
S-001	Coffee boiler is heating...	Wait until the coffee boiler has reached its nominal temperature.	-
S-002	Bean hopper rear missing	Check if the bean hopper or lid is inserted correctly.	"5.4" on page 56
S-003	Bean hopper front missing	Check if the bean hopper or lid is inserted correctly.	"5.4" on page 56
S-004	Please empty the grounds drawer.	The grounds drawer must be emptied before cleaning can be started	"5.8" on page 62
S-005	Risk of injury! Please empty the grounds drawer carefully. The grounds drawer was filled with hot water during cleaning.	During cleaning the grounds drawer is filled with water. Empty it carefully!	"5.8" on page 62
S-006	Grounds drawer is full	The grounds drawer has to be emptied.	"5.8" on page 62
S-007	Please insert grounds drawer	Empty and insert grounds drawer.	"5.8" on page 62
S-008	Please insert the grounds drawer.	The coffee machine can only continue if the grounds drawer is inserted.	"5.8" on page 62
S-009	Grounds drawer missing	The sensor has detected that the grounds drawer is missing.	"5.8" on page 62
S-010	Bean hopper front is empty or locked. Please refill or unlock the bean hopper.	The brewing module has detected no coffee powder in the chamber. The bean hopper front has to be refilled or unlocked.	"5.4" on page 56
S-011	Bean hopper rear is empty or locked. Please refill or unlock the bean hopper.	The brewing module has detected no coffee powder in the chamber. The bean hopper rear has to be refilled or unlocked.	"5.4" on page 56
S-012	Bean hopper is empty or locked. Please refill or unlock the bean hopper.	The brewing module has detected no coffee powder in the chamber. The bean hopper has to be refilled or unlocked.	"5.4" on page 56
S-013	Coffee quantity too high (last product).	Too much powder coffee was used. Use less coffee next time. If the error remains, contact your service organisation.	"5.6.6" on page 60
S-014	Rinse necessary. The coffee boiler isn't allowed to heat before the machine is rinsed.	Press the rinse key in the upper right corner.	"5.3" on page 55

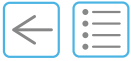

#	Info message	Explanation / Corrective action	Refer to
S-027	Interface not detected. All coffee products are locked. Please check the interface connection and setting.	This message only occurs if you use an external interface (CSI or CCI).	"9.2" on page 102
S-028	The milk system has been cleaned without detergent. The coffee machine is blocked now until the next cleaning with Everclean!	Can only occur if you have set the parameter "If cleaned without detergent" to "Block after 4 days". The coffee machine is blocked now until the next cleaning with detergent!	"11.3.5" on page 128
S-029	Milk fridge door open. Please close the fridge door properly.	This message is only set if monitoring of milk fridge door is activated. Close the fridge door.	"11.3.7" on page 128
S-030	Source water tank empty. Please refill source water tank.	Reed switch has detected that the source water tank is empty. - Refill the source water tank. - Check reed switch and cable.	"9.2" on page 102
S-031	Waste water tank full. Please empty waste water tank.	Reed switch has detected that the waste water tank is full. - Refill the source water tank. - Check reed switch and cable.	"9.2" on page 102
S-032	Milk unit not connected. Water pump has been switched off.	Milk products blocked! Contact service organisation.	-
S-033	Touch Screen open. Please close the display properly.	Machine blocked! Contact service organisation.	-
S-034	Bean hopper rear is empty or locked. Please refill or unlock the bean hopper.	The brewing module has detected no coffee powder in the chamber. The left bean hopper has to be refilled or unlocked.	"5.4" on page 56
S-035	Bean hopper front is empty or locked. Please refill or unlock the bean hopper.	The brewing module has detected no coffee powder in the chamber. The right bean hopper has to be refilled or unlocked.	"5.4" on page 56
S-100	Steam boiler is heating...	This message occurs if the steam boiler pressure is below 0.8 bar and the boiler starts to heat to the nominal value (e.g. in the morning after switching on the coffee machine)	-
S-101	Please switch off the machine	This message occurs if the steam boiler has been emptied or de-pressurized. The coffee machine has to be switched off (main switch).	"5.9" on page 63
S-102	Empty steam boiler...	Contact service organisation.	-
S-103	Depressurize steam boiler...	Contact service organisation.	-
S-104	Fill steam boiler...	If the water level is lower than the safety level the steam boiler has to be filled. Wait until the steam boiler is filled.	-

8 Troubleshooting



#	Info message	Explanation/Corrective action	Refer to
S-105	Rinse necessary. The steam boiler isn't allowed to heat before the machine is rinsed.	After switching on the coffee machine, the steam boiler has to wait until the rinse button is pressed before it is allowed to heat. Press the rinse button.	"5.3" on page 55
S-106	Initialise, please wait...	Just wait until the coffee machine is initialised.	-
S-107	Steam boiler security probe problem.	Contact service organisation.	-
S-108	Interface not detected. All steam and hot water products are locked. Please check the interface connection and setting.	This message only occurs if you use an external interface (CSI or CCI).	"9" on page 101
S-109	Touch Screen open. Please close the display properly.	Contact service organisation.	-
W-002	Coffee boiler is heating...	If this message remains, call your service organisation.	-
W-004	Water flow too low	Contact service organisation.	-
W-006	Check cleaning ball dispenser. Blocked or broken cleaning balls. Light barrier dirty?	Contact service organisation.	-
W-007	The coffee machine has been cleaned without cleaning balls. Cleaning ball dispenser empty? Blocked or broken cleaning balls?	This warning is set if no cleaning ball has been detected. Check if the cleaning ball dispenser is empty. If yes -> Refill it. Check if a cleaning ball is blocking the dispenser. If this message remains, call your service organisation.	"7.3.7" on page 89
W-008	Press "Continue" to start cleaning now. If you want to start cleaning later, press the stop button.	To start cleaning later, press and hold the rinse key for three seconds to start cleaning.	"7.3.1" on page 80
W-009	Cleaning ball dispenser missing.	Contact service organisation.	-
W-010	Invalid coffee recipe	No action necessary. This message disappears with the next successful coffee product. Normally this message should never appear.	-
W-011	Brewing unit initialisation failed. The brewing unit is blocked. => Please check the brewing unit.	Contact service organisation.	-
W-013	Service necessary. Please contact your service technician.	The machine has reached the predefined number of products or the service date interval has elapsed. Please call your service technician.	-

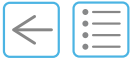

#	Info message	Explanation / Corrective action	Refer to
W-014	Please change the water filter.	Predefined water amount has been reached. The water filter has to be changed after its life time cycle. Otherwise the boilers will be damaged due to the limescale. Please call your service technician.	-
W-018	Milk tank empty. Please refill the milk tank.	Refill the milk tank.	"9.2.1" on page 102
W-019	Steam pressure too low for milk products.	Wait until the steam pressure is high enough to produce a milk product.	-
W-021	Top piston failure. The machine tries to unblock the piston automatically.	Contact service organisation.	-
W-022	Bottom piston failure left. The machine tries to unblock the piston automatically.	Contact service organisation.	-
W-023	Bottom piston failure right. The machine tries to unblock the piston automatically.	Contact service organisation.	-
W-024	Milk tank empty. Please refill the milk tank.	Refill the milk tank.	"9.2.1" on page 102
W-025	No grinder turns detected (grinder right, bean hopper front). The grinder automatically tries to start again.	The grinder automatically tries to unblock itself (that normally solves the problem). But if it can't unblock itself after three times, the grinder is blocked and intervention is necessary (the warning W-068 is set).	-
W-027	Date and time incorrect. Please adjust the date and time in the display menu and restart the machine.	<ul style="list-style-type: none">- Turn the coffee machine off (main switch and not standby button!), wait 10s and turn it on again (that mostly fixes the problem).- But if the message is still shown after turning off and on the machine login with manager password and:<ul style="list-style-type: none">- Adjust the date and time at the display => Main Menu => Display => Date and Time => Set Date & Time => Check also if the time zone is correct on the display(s) If the message still appears after manually setting the date and time and restarting the machine, please call your service technician.	"11.3.3" on page 126
W-029	Failure of external EEPROM (CPU)	Contact service organisation.	-
W-030	Failure during backup to external EEPROM (CPU)	Contact service organisation.	-
W-034	No coffee powder detected (left). Please check the powder chute and press "Continue".	Check the powder chute. Have you inserted enough powder?	"5.6.6" on page 60
W-035	No coffee powder detected (right). Please check the powder chute and press "Continue".	Check the powder chute. Have you inserted enough powder?	"5.6.6" on page 60

8 Troubleshooting



#	Info message	Explanation/Corrective action	Refer to
W-037	The milk system was cleaned without detergent. Please use "Everclean"!	None or not sufficient detergent detected for a proper cleaning of the milk system.	"7.3.1" on page 80
W-038	Coffee boiler temperature sensor failure left. Please check the temperature sensor and cable.	Contact service organisation.	-
W-040	Milk heater temperature sensor failure left. Please check the temperature sensor and cable.	Contact service organisation.	-
W-048	During the weekend all milk products are locked!	Occurs only if you have turned on "Cleaning Weekend Mode" ("Clean/Standby" menu)	"11.3.5" on page 128
W-050	Fan Front doesn't run. Check if the fan is plugged in correctly.	Contact service organisation.	-
W-054	Milk pump doesn't run.	Contact service organisation.	-
W-056	Milk input temperature sensor failure. Please check the temperature sensor and cable.	Contact service organisation.	-
W-058	Milk tank temperature left too high. Please fill the milk tank with cold milk.	The temperature of the milk in the fridge is too high. Use and refill only cooled milk.	"9.2" on page 102
W-060	Milk module not connected.	Contact service organisation.	-
W-065	Please schedule next service with your service technician.	In the next few weeks a service will be necessary. It's good to plan the next service early enough (no last minute action). Please call your service technician.	"7.1.2" on page 77
W-066	Please schedule water filter change with your service technician.	In the next few weeks a water filter change will be necessary. It's good to plan the next water filter change early enough (no last minute action). Please call your service technician.	"7.1.2" on page 77
W-068	The left grinder is blocked. Close the left bean hopper. Press "Continue" to start automatic grinder unblocking.	Contact service organisation.	-
W-075	The extraction time is too high. Please press "Continue" to start a rinse.	The extraction time is more than 15 s too long three times running. To check if the machine has a problem, a rinse will be performed after pressing "Continue". If the warning doesn't disappear after the rinse, login with manager password: => Consult the rinse history for more information => Please call your service technician.	"11.3.1" on page 124

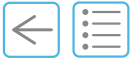

#	Info message	Explanation / Corrective action	Refer to
W-077	The flow rate during rinse is too high. Consult the rinse history for more information.	The flow rate during rinse on the left side is higher than 15 ticks/s. Please call your service technician.	"11.3.1" on page 124
W-080	The left grinder could not be automatically unblocked. Press "Continue" to start manual grinder unblocking.	Contact service organisation.	-
W-084	Bean level left too low. Please refill the bean hopper.	Light barrier detected no coffee beans in left hopper. Refill bean hopper. If warning remains, please call your service technician.	"5.4" on page 56
W-086	Initial rinse of milk system hasn't been performed yet. Check if you are logged out.	Make sure that you are being logged out so that the init rinse can start.	"6.9" on page 74
W-101	Steam boiler pressure too high	Contact service organisation.	-
W-103	Steam wand left temperature sensor failure. Please check the temperature sensor and cable.	Steam or everfoam blocked! Contact service organisation.	-

8.3 FAQs

8.3.1 Bean hoppers unlocked

The coffee dispensed is watery.

The bean hopper is empty or closed so no beans have access to the grinder.

↪ Fill or lock the bean hoppers in the open position.

[See chapter "5.4 Fill the coffee bean hoppers" on page 56](#)

8.3.2 No water connected

The main water tap (usually under the counter) or the coffee machine water tap (under the drip tray) are closed.

↪ Open all the water taps.

[See chapter "1.7 Special safety instructions and signs" on page 15](#)

[See chapter "5.2 Switch on" on page 54](#)

8.3.3 No milk dispensed

No milk is dispensed, but the milk tank in the refrigerator is not empty.

↪ Check that the milk is cold enough (3 °C). Always fill the milk tank with pre-cooled milk.

↪ Check that the end of the milk in-take tube lay on the bottom of the filled milk tank.

↪ Check that the milk tube is not pinched and in good condition.

[See chapter "9.2.1 Refill" on page 102](#)

8.3.4 Steam wand is clogged

↪ The steam wand needs to be purged before and after every product preparation.

[See chapter "5.6.5 Steam purge button" on page 59](#)



Not using the purge will slowly block the pipe inside. Make purging your regular procedure or refer to chapter ["7.3.8 How to clean the steam nozzle" on page 90](#).

8.3.5 Cups on the cup heater are not warm enough.

↪ Cups can be topped up to a maximum of 2 layers to have an effective cup heating function.

↪ The cup heater is not intended to keep cups warm in a cold air flow (e.g. near an open window or door). [See chapter "5.5 Cups heating surface" on page 56](#)

↪ Contact your service engineer to verify the heating panel settings.

Options 9

Chapter Overview

This chapter describes Enigma options.

9.1 Option list

Enigma model	E'2ct	E'2s	E'2m	E'4s	E'4m	E'4s x-wide	E'4m x-wide	E'6s	E'6m	E'6m
E'fridge	✓	✓	✓	✓	✓	✓	✓	✓	✓	9.2 on p.102
E'cup heater	✓	✓	✓	✓	✓	✓	✓	✓	✓	9.3 on p.104
E'choco	✓	✓	✓	✓	✓	✓	✓	✓	✓	9.4 on p.105
Under counter ground coffee disposal	✓	✓	✓	✓	✓	✓	✓	✓	✓	9.5 on p.111
Without steam wand	✗	✓	✓	✓	✓	✓	✓	✓	✓	9.6 on p.112
Cold foam	✗	✗	✓	✗	✓	✗	✓	✗	✓	9.7 on p.113
Option selection 2 milk types (dual milk)	✗	✗	✓	✗	✓	✗	✓	✗	✓	9.8 on p.113
High hot water outlet (215 mm)	✓	✓	✓	✓	✓	✓	✓	✓	✓	9.9 on p.114
Without hot water outlet	✗	✗	✓	✗	✓	✗	✓	✗	✓	9.6 on p.112
Bean hopper lock	✓	✓	✓	✓	✓	✓	✓	✓	✓	9.11 on p.116
1.5-Step	✗	✗	✓	✗	✓	✗	✓	✗	✓	9.12 on p.116
Single coffee outlet	✓	✓	✓	✓	✓	✓	✓	✓	✓	9.13 on p.117
Cup centering guide	✓	✓	✓	✓	✓	✓	✓	✓	✓	9.14 on p.118
Colour Earth/Tempest	✓	✓	✓	✓	✓	✓	✓	✓	✓	9.15 on p.118



The shotmaster range has the same options as the Enigma range, except the Shotmaster pro that can only dispense milk via the 1.5-Step. It can not dispense milk via the Coffee spout.

Steam wands are not optional on Shotmaster.

9.2 E'fridge

There are many different refrigerators on the market, so please note that your fridge may look different to the configuration shown below.



Before carrying out any operation on the E'fridge, it is imperative to read the User Manual and fully understand it. In case of any doubt, consult your local service organisation.



RISK OF EXPLOSION.

Never store inflammable or explosive goods inside the fridge!

9.2.1 Refill



Always clean your hands before refilling milk. Germs can be introduced from dirty hands when opening.

Only use cooled milk (pasteurised, homogenised or UHT).

To refill the E'fridge with milk proceed as follows:

- A.** Make sure that the E'fridge is switched on and operating correctly, open the door and check that the temperature is not higher than 3°C (-16°F).
- B.** Remove the milk tank from the E'fridge and the milk tank cover.
- C.** Clean the milk tank with soft soap, rinse under running drinking water and dry it.
- D.** Fill with cold fresh milk (1) and replace the milk container lid.
- E.** Carefully replace the milk tank in the E'fridge, ensure to insert the milk tube (2) inside the milk tank and that it correctly lays on the bottom of the milk tank.
- F.** Close the E'fridge door.

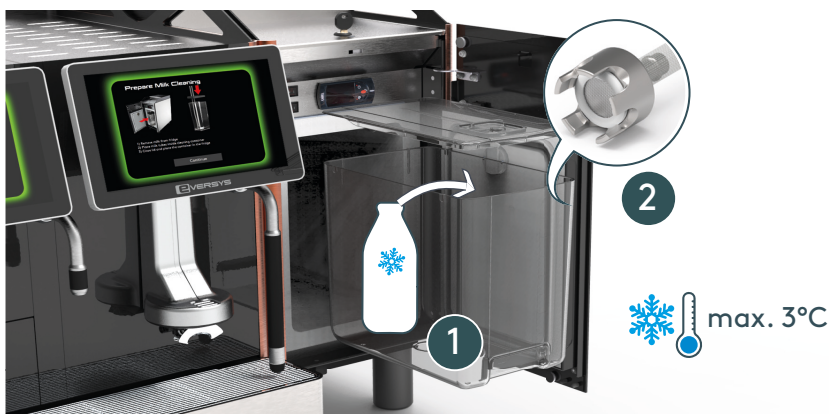

Fig. 9-1

9.2.2 Optional countertop cut-out dimensions



ShotMaster / Enigma
ShotMaster/Classic
E'2 - E'4 - E'4 x-wide - E'6/Classic

Scale/Skala/Echelle/规模/규모	A0
	1:1

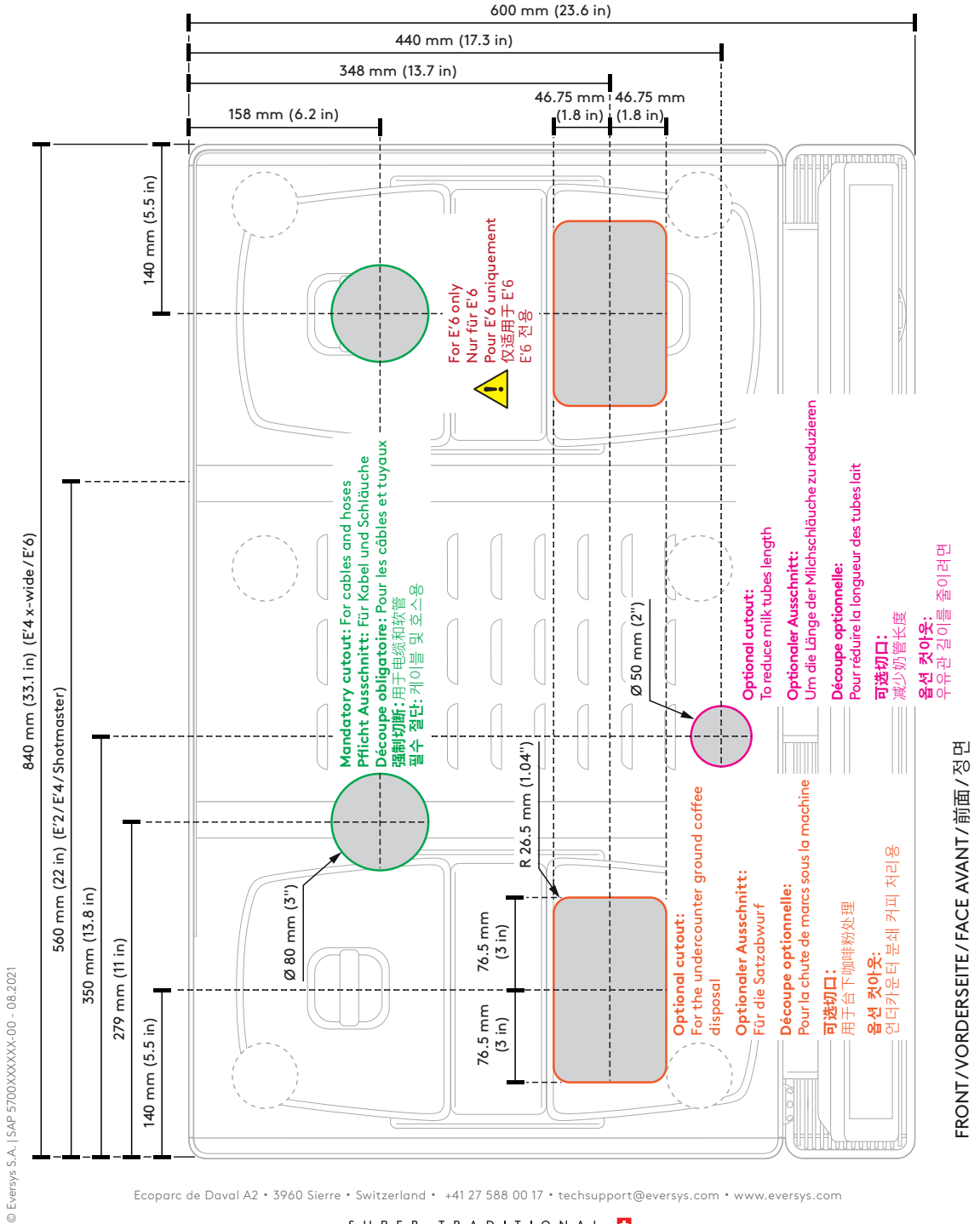

Fig. 9-2

Use either the green or the option pink holes for the milk tubes.

9.3 E'cup heater



Before carrying out any operation on the E'cup heater, it is imperative to read the User Manual and fully understand it. In case of any doubt, consult your local service organisation.

Be careful as the cups, the heating panel and the heating drawers may be hot (90°C).

E'cup heater will be available starting November 2021.



Fig. 9-3

Refer to the E'cup heater User Manual or the quick start guide provided with the machine for more information.

9.4 E'choco

The E'choco is a powder dispensing system. It allows to dispense powder products such as chocolate powder mixed with water from the coffee boiler.

The E'choco is intended for use on Enigma and Shotmaster machines only.



Fig. 9-4

9 Options



9.4.1 Technical specifications (datasheet)



E'choco/Classic
(Enigma not included)

Select your colour:

Earth

Tempest

Classic	E'choco
Weight	23 kg
Powder containers	2 x 1.5 kg
Hardware configuration	Enigma pre-configuration necessary
Mechanical configuration	Enigma with E'choco predisposition
Software	v3.x and higher
Voltage	24 V provided by the Enigma
Power consumption	--
Locking system	Key
Installation specifications	Only setup on the left side of the Enigma For use with Enigma machines only

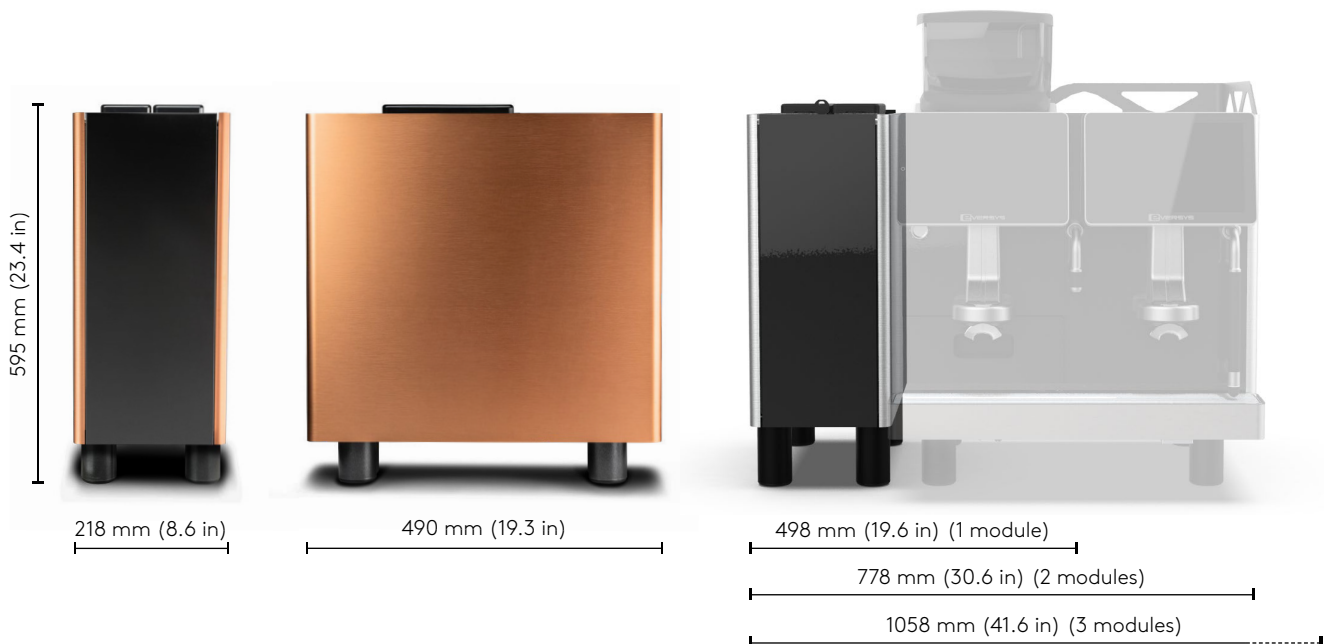

9.4.2 Fill with powder



Never try to reach into the mixers. This may cause injury by pinching (3).



Only use powder suitable for automatic machine. Ensure that no foreign object gets into the mixers. This may block or damage them.

- A. Remove the covers (1).
- B. Fill with powder (2).
- C. Replace the covers.



Fig. 9-5

9.4.3 Make a powder drink



- A. Place a cup under the coffee outlet.
- B. Press a choco button preconfigured by your service engineer.



If you have **Manager** access it is possible to adjust the amount of water.

Press **Powder Sequence** (1) and adjust water **Quantity** (2). Press **Product Test** (3) and press check (4) when done.

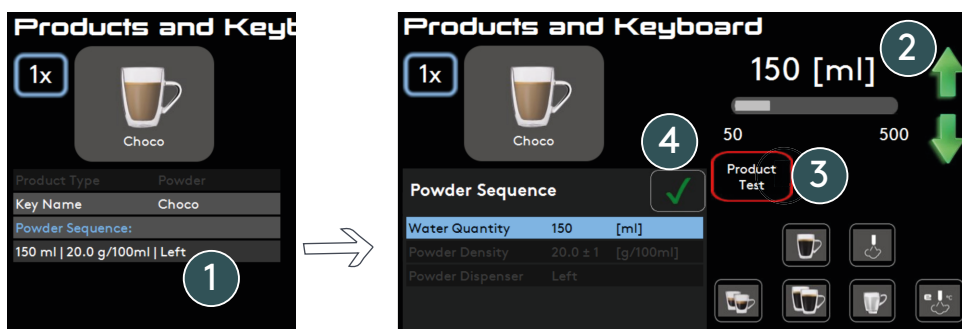

Fig. 9-6

9.4.4 E'choco Daily care (Automatic system cleaning)

It is important to clean your E'choco unit daily. When requested by the software (Automatic system cleaning) or when necessary, please follow this procedure or watch this [cleaning video](#).

- A. Open the E'choco door (1).
- B. Turn the powder chutes upwards (2) and remove both of them (3).
- C. Unplug the tube (4) from the panel.



Fig. 9-7

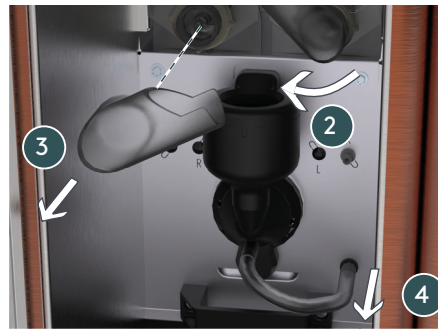

- D. Turn the handle upwards (CCW) (5) to unlock the mixer.
- E. Gently remove the mixer (6). Separate the mixer cover and base (7).
- F. Clean all under tap water with soft soap (8). Dry the parts.

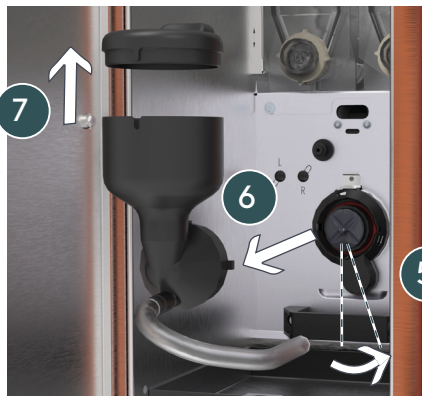
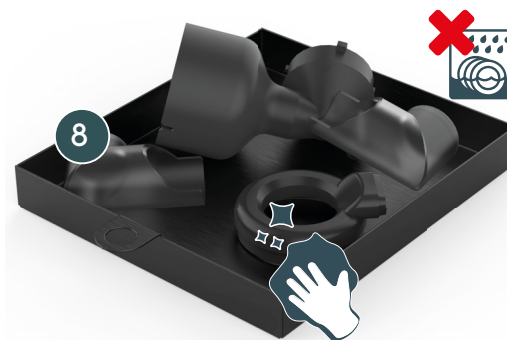

Fig. 9-8



- G. Assemble the mixer cover and base (9) and correctly position it inside the E'choco (10).
- H. Replace the powder chutes (11), lock the handle (12) and plug the tube (13).

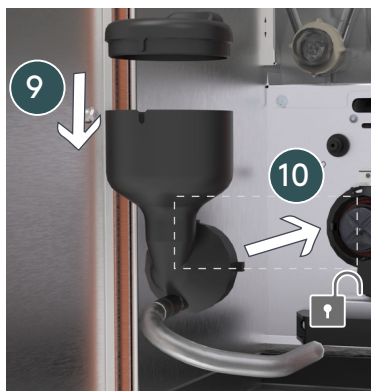
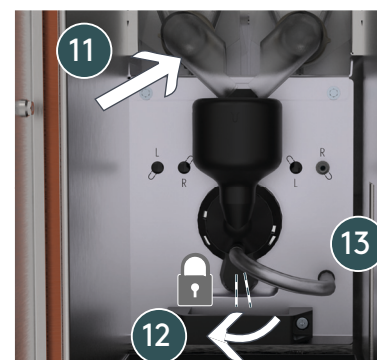
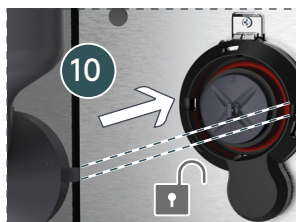

Fig. 9-9





- I. Close the door (14).
- J. Press **Continue** on the software to finish the cleaning process (15).



Fig. 9-10

9.4.5 E'choco Weekly care

Empty and clean the powder container

- A. Switch off the machine at the main switch (see "5.9 Switch off" on page 63).
- B. Remove the top panel (1) and the covers (2).
- C. Pull the containers and lift to remove them (3).
- D. Remove the powder chutes (4).
- E. Clean all parts under tap water with soft soap (5).
- F. Dry the parts and replace them inside the E'choco unit.
- G. Clean the choco outlet according to chapter "7.3.2 Coffee/milk outlet V2 (metal)" on page 85.

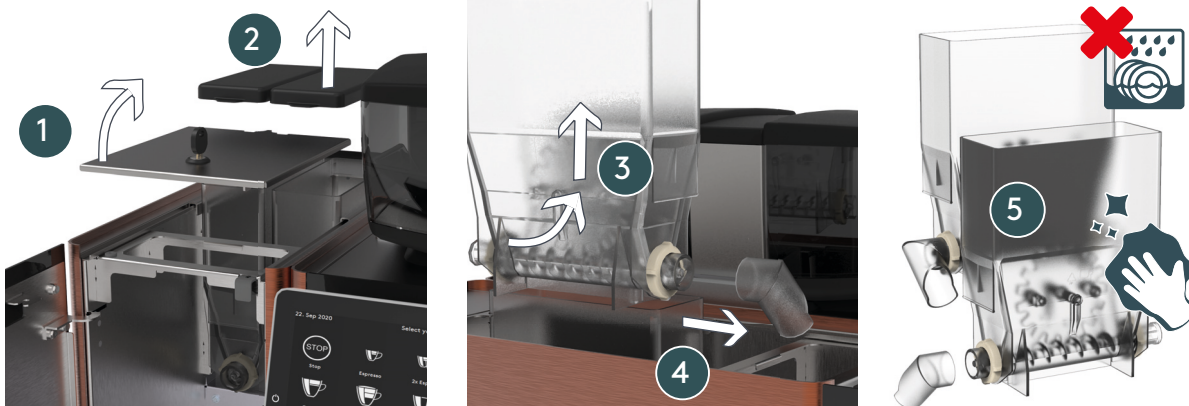

Fig. 9-11

9.5 Undercounter ground coffee disposal

The undercounter ground coffee disposal allows a higher amount of coffee grounds in the bin.

Your service engineer will configure settings according to your needs during initial commissioning.



Fig. 9-12

- (1) Black grounds bin drawer; for normal use (with a hole).
- (2) Red cleaning drawer; for use during cleaning process. The software will display a warning message to replace the black grounds bin by the red cleaning drawer and to remove it when necessary.
- (3) Grounds chute tube inserted into the countertop cut-out by your service engineer during initial commissioning.

Refer to [“9.2.2 Optional countertop cut-out dimensions”](#) on page 103

9.6 Without steam wand or hot water outlet

No steam wand or hot water outlet is installed (1).



Everfoam, manual steam and auto steam functions described in this manual are not available if there is no steam wand.



Fig. 9-13

9.7 Cold milk foam

This option enables cold foam.

Your service engineer will configure the settings according to your needs during initial commissioning or after an update.

9.8 Option selection 2 types of milk

This option enables the possibility to dispense products with two different types of milk.

E'fridge beside is available with a dual milk configuration.



Fig. 9-14



**If using e.g. regular milk on milk tank #1 and e.g. soy milk on milk tank #2, it is not possible to guarantee Lactose-Free Milk on milk tank #2.
Except if you have a machine with two different milk modules e.g. E'4m.**

9.9 High hot water outlet

The high hot water outlet allows you to use cups that are up to 215 mm high.

The standard height is 160 mm.

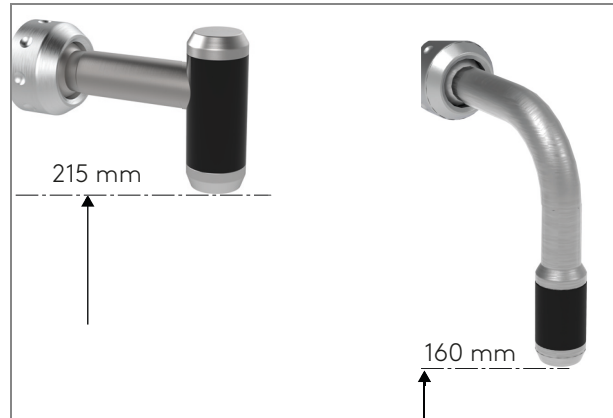

Figure 9-15

9.10 Decaffeinated powder chute

This options allows to use ground coffee in the decaffeinated powder chute.



Only add grounded coffee in the decaffeinated powder chute!



Depending on settings, the **Decaf.** button may not be displayed in the products area. Refer to chapter [“11.4.3 Display” on page 100](#) for more information.

- A. Place a cup under the coffee outlet.
- B. Press the button with the measuring scoop (2).
- C. Select a product (3).
↳ The **Powder chute** screen displays.
- D. Open the powder chute (4) and add one portion of ground coffee max. 20 g. Use espresso fine grind coffee for optimal in-cup quality.
- E. Close the powder chute lid (4) and press **Continue** (5) to dispense the product.

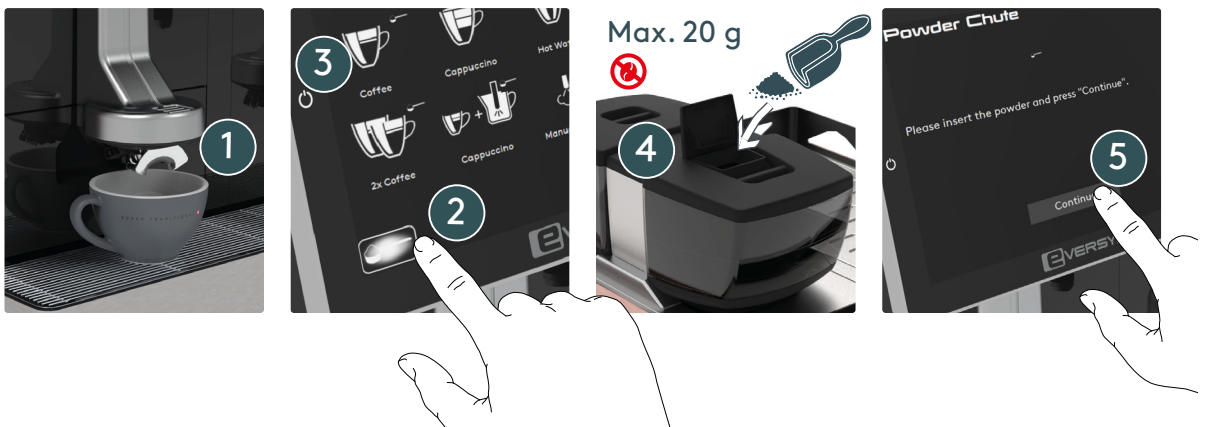

Fig. 9-16

9.11 Bean hopper lock

The bean hopper lock is available for safety purposes (e.g. self-service machines).



Fig. 9-17

9.12 1.5-Step (milk arm)

The 1.5-Step is a milk arm that allows to dispense perfect foam at the same time of an espresso and lets the Barista concentrate on latte art.

- A. Clean the 1.5-Step milk arm (1) with a clean cloth daily or as required.



Fig. 9-18

9.13 Single coffee outlet



The single outlet enhances customer experience for self-Service machines and it is easy to swap between the single outlet back to the double outlet at any time.

- (1) Single coffee outlet
- (2) Single milk outlet
- (3) Single water outlet
- (4) Chocolate outlet (choco/powder option)

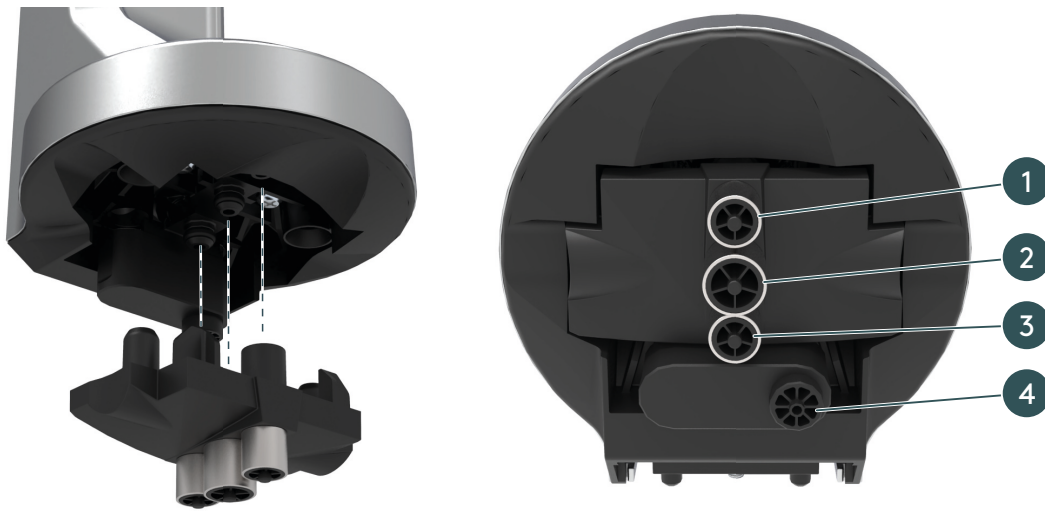

Fig. 9-19

9.14 Cup centring

A guide is clipped to the drip tray, to help centre cups under the coffee outlet.

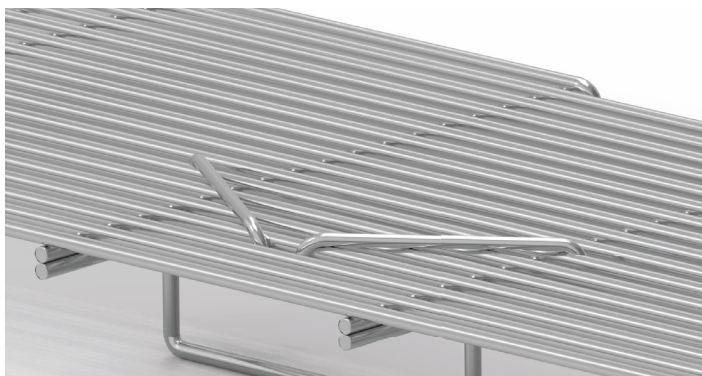

Fig. 9-20

9.15 Colours

Enigma available colours are:

- (1) Earth (is the colour illustrated in this manual)
- (2) Tempest

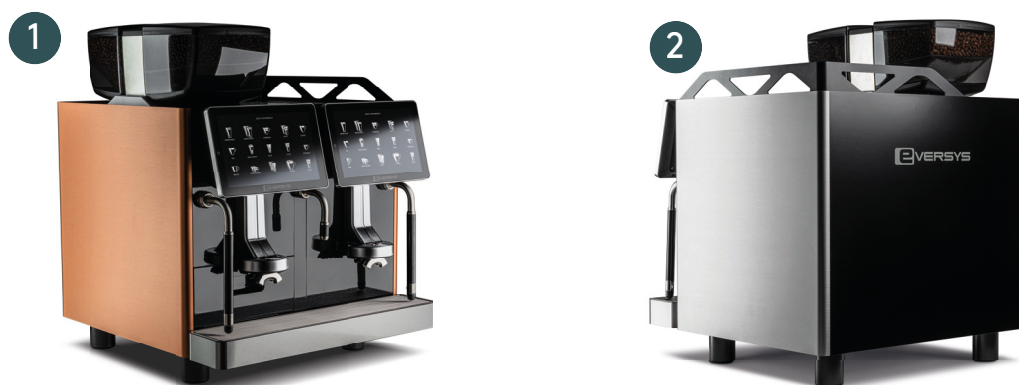

Fig. 9-21

Warranty and Generalities 10

This chapter describes the warranty limitations and basic information on the machine and the document structure.

10.1 Warranty

Each Coffee Machine manufactured by Eversys is guaranteed to be free of defects in workmanships and material when leaving the factory. The guarantee is valid for a period of 24 months or 100'000 products per group head (whichever comes first) from the date of installation.

Eversys will repair or replace at its discretion part or all of the product not conforming to this warranty. Eversys' responsibility under this warranty is limited to the repair or replacement of defective parts and not to wear and tear parts and maintenance products. Furthermore, the warranty is not provided if:

- The instructions on how to handle, install or operate the machines or spare parts are disregarded
- The Coffee Machines have been disassembled or modified or repaired with non-original components by a person and/or company not approved by Eversys
- The Coffee Machines have been utilised for an application for which it was not intended to be used
- Installation and regular maintenance have not been done properly and on time and conducted by a person and/or company duly approved by Eversys
- Water quality does not correspond to Eversys criteria.

Each spare part manufactured by Eversys is guaranteed to be free of defects in workmanships and material when leaving the factory for a period of 12 months valid from date of shipment.

Each refurbished part manufactured by Eversys is guaranteed to be free of defects in workmanships and material when leaving the factory for a period of 6 months valid from date of shipment.

In order to be able to claim against our warranty you have to send us back the completed installation form for each machine. Any Spare Part delivered under warranty will have to be sent to Eversys within 90 days, after which Eversys will be obliged to invoice it.

All cleaning materials used for Eversys machines must have been authorised by the manufacturer. Not using Eversys cleaning materials will make the warranty null and void.

10.2 Warranty limitation

Eversys S.A. denies any responsibility in case of:

- incorrect use of the coffee machine.
- authorised modification (willingly or unwillingly).
- not complying with the instructions contained in the manuals provided with the coffee machine.
- not complying with the safety instructions contained in the manuals.
- damage linked to the use of the machine, in particular any loss of data or any financial loss which might be associated with the use of the software.
- if the machine is used in a manner not specified by the manufacturer, the protection provided by the coffee machine may be impaired.

When the coffee machine is connected to a host, the user takes the entire responsibility for errorless transmission of the results (e.g. hardware, software and firmware) to this system.



Any warranty will be deemed void in the following cases: Installation of the machine by unauthorised persons; Installation non conforming with our datasheet; Misuse causing damage; Maintenance by unauthorised persons; Mandatory service and maintenance schedule not respected; Mandatory daily cleaning not respected; Damage due to improper storage; Use contrary to the instructions given in this manual or according to information other than the manufacturer's original tips.

Each Enigma is tested by Eversys S.A. before shipping.

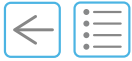

10.3 Glossary

The following terms and acronyms are used in this manual.

10.3.1 Acronyms

m (m-pro)	Coffee, tea, milk, steam
s (s-pro)	Coffee, tea, steam
ct	Coffee, tea
x-wide	Self service/wide machines
ST	Super Traditional
EMT	Electronic Milk Texturing system with heating/steaming module
MAD	e'Foam, with Micro Air Dosing system (everfoam)

10.3.2 «Persons»

Manufacturer

See “[Manufacturer](#)” on page 2.

User

The term «user» is the final person, end user, using the coffee machine to dispense coffee or any other product.

Operator

The term «operator» is the owner of a Enigma both when using it as its owner and when transferring it to a third-party.

Personnel

The term «personnel» encompasses persons who have any kind of activity with the Enigma and who are qualified in accordance with the manufacturer’s requirements and are consequently authorised.

Manager

The term «manager» designates duly trained persons who are permitted to perform specific tasks on the Enigma.

Service engineer

The term «service engineer» designates duly trained persons who are permitted to install, maintain and service the Enigma.

Service organisation

The term «service organisation» designates the organisation which is permitted to appoint «service engineers» and is your contact from servicing to user training.

10 Warranty and Generalities



10.3.3 Injury

Minor Injury

A reversible injury that does not require medical treatment.

Moderate Injury

A reversible injury that does require medical treatment.



10.3.4 Products

Machine

This is the Enigma coffee machine manufactured by Eversys S.A.

Everfoam (e'Foam)

The Eversys' improved Foam system provides a 2-step Barista solution. This generation of e'Foam allows you to texture the milk by product type. This is done through the Micro Air Dosing (MAD) system controlled electronically.

Eversys cleaning balls™

Coffee brew module cleaning product.

Everclean™

Milk system cleaning product.

10.3.5 Coffee terms

Coffee product types (non-exhaustive list)

Espresso	The espresso is the foundation and the most important part to every espresso-based drink.
Ristretto	A ristretto is an espresso that is extracted with the same amount of coffee but half the amount of water.
Coffee	A coffee is an espresso that is extracted with the same amount of coffee but the amount of water is doubled.
Americano (long black)	An Americano is hot water with an espresso extracted on top of the hot water.
Coffee pot	An American-based (one or two espresso) but sets with multiple cycles in order to fill the pot.
Macchiato	A Macchiato is an espresso but with a dollop of foamed milk on top.
Latte macchiato	Latte macchiato is a 3-layer product with cold milk at the bottom, one espresso in the middle and hot foamed milk on top.
Cappuccino	A cappuccino is a mix of coffee and hot milk with hot foam milk on top.
Flat white	A flat white is a coffee you'll primarily find in Australia and New Zealand. It is a mix of coffee and hot milk with 5 mm hot foam milk on top.
Piccolo latte	A piccolo latte is a caffè latte made in an espresso cup. This means it has a very strong but toned-down espresso taste thanks to the steamed milk and micro foam within it.
Decaf	Decaffeinated coffee

Barista

A person who is specially trained in making and serving coffee drinks, as in a coffee bar.

10.4 Typographical conventions

The following styles are used in this manual.

10.4.1 Warning



Warning messages are signaled by this symbol and bold type. The main risk appears in capital letters (e.g. RISK OF BURNS). Non-compliance with these messages may result in damage to the machine, causing burns or in having to stop a product.

They are used to designate:

- an imminent and dangerous situation which, if not avoided, may lead to moderate injury of the user;
 - or a potentially dangerous situation which, if not avoided may lead to minor injury of the user.
-

10.4.2 Note



Notes are indicated by this symbol.

They indicate a preferred procedure or recommended use and/or a general informative remark.

10.4.3 Notation

- Procedures: Text preceded by a letter (**A, B, C**) indicates a procedure to be carried out step by step.
- Cross-references and links: this style is used as **bold italic and in blue**.
- Procedure results use this symbol: .
- Software buttons: text in bold italic style is used (e.g. **OK, Save, Rinse**).
- List of numbers: text linked to an illustration (**1, 2, 3**).

Appendix 11

Chapter overview

This chapter contains additional content such as the equipment list, user manager module and more.

11.1 Equipment list

Description	Quantity
Enigma machine	1
Eversys™ cleaning balls container (62 pcs)	1
Water inlet hose (G3/8" female x 2 m)	1
Hose clamp 16-27 mm	1
Drain hose (Ø22 x Ø16 x 2 m) Ø 22 x Ø 16 x 2 m (Ø 0.9 x Ø 0.6 x 78.7 in)	1
Drain connection	1
O-ring (Ø15.6x1.78 mm)	1
Everclean™ (machines with milk only)	1
Everclean™ 1 liter cleaning container (machines with milk only)	1
Quick start and cleaning guide	1
Installation and warranty form	1

11.2 Spare Parts Ordering

Please contact your local service organisation or connect to the [webshop](#).

11.3 User rights

The table below describes the menu user level rights according to the manufacturer's default settings when the Enigma is shipped.

- Operator (user basic)
- Manager (super user)
- Technician (advanced - service engineer access only) - Contact your service organisation for more information.

11.3.1 Statistic/History

Parameter	Default	Operator	Manager	Technician	See chapter
Product Counter	-	✓	✓	✓	"6.3.1" on page 68
- Day counter	-	✓	✓	✓	"6.3.1" on page 68
- Period Counter	-	✓	✓	✓	"6.3.1" on page 68
- Total counter	-	✓	✓	✓	"6.3.1" on page 68
Machine Counter	-	-	-	✓	-
History	-	-	-	✓	-
- Product history	-	-	-	✓	-
- Error history	-	-	-	✓	-
- Cleaning history	-	-	-	✓	-
- Rinse history	-	-	-	✓	-
- Service history	-	-	-	✓	-

11.3.2 Product & Keys (e.g. Cappuccino)

Parameter	Default	Operator	Manager	Tech	See chapter
software page 1/2					
1 x	1x	-	-	✓	Contact service
2 x	-	-	-	✓	Contact service
Product test	-	-	✓	✓	"6" on page 69
Learn quantity	-	-	✓	✓	"3" on page 69
Product type	Cappuccino	-	-	✓	Contact service
Key name	Cappuccino	-	✓	✓	"6.4" on page 69
Bean hopper (Rear or front)	Rear	-	-	✓	Contact service
Water quantity [tick]	50	-	✓	✓	"6.4" on page 69
Cake thickness [mm]	14	-	-	✓	Contact service
Tamping [kg]	20	-	-	✓	Contact service
Pre-Infusion [s]	0.8	-	-	✓	Contact service
Relax Time [s]	2.0	-	-	✓	Contact service
Second tamping [mm]	2.0	-	-	✓	Contact service
software page 2/2					
Bypass quantity [%]	0	-	-	✓	Contact service
Coffee cycles [#]	1	-	-	✓	Contact service
Appearance	white on top	-	-	✓	Contact service
Milk Delay time [s]	0.0	-	-	✓	Contact service
Milk Sequence(s):	popup				
	#1: 9.0s 80% warm One				
Milk quantity [s]	9.0	-	✓	✓	"6.4" on page 69
Foam texture	80	-	-	✓	Contact service
Milk temperature	Warm	-	-	✓	Contact service
Milk sort	One	-	-	✓	Contact service
Powder Sequence:	popup				
	#1: 100 ml 20.0 g/100 ml Left				
Water quantity [ml]	100	-	✓	✓	n/a
Powder density [g/100 ml]	20.0±1.0	-	-	✓	Contact service
Powder dispenser	Left	-	-	✓	Contact service

11.3.3 Display

Parameter	Default	Operator	Manager	Tech	See chapter
software page 1/2					
Import screen	-	-	✓	✓	"6.5.1" on page 71
- Start Import	-	-	✓	✓	"6.5.1" on page 71
- Convert CSV to JSON-file	-	-	✓	✓	"6.5.1" on page 71
- Delete screen	-	-	✓	✓	"6.5.1" on page 71
Import Language	-	-	✓	✓	"6.5.2" on page 71
- Start Import	-	-	✓	✓	"6.5.2" on page 71
- Delete All Languages	-	-	✓	✓	"6.5.2" on page 71
Language	EN	-	✓	✓	"6.5" on page 70
Date and Time	DD.MM.YY	-	✓	✓	"6.5" on page 70
Screen style	Standard	-	-	✓	Contact service
Number of display layer	2	-	✓	✓	"6.5" on page 70
Automatic go back to layer 1	Yes	-	-	✓	Contact service
Number of keys per layer	15	-	-	✓	Contact service
Screensaver	off	-	✓	✓	"6.5" on page 70
Front Lighting	Mix	-	✓	✓	"6.5" on page 70
software page 2/2					
Show extraction counter	No	-	-	✓	Contact service
Colorize extraction time	Off	-	-	✓	Contact service
Lock Function (stop button)	Off	-	-	✓	Contact service
Standby button	On	-	-	✓	Contact service
Show powder chute selector	No	-	-	✓	Contact service
Show milk selector	No	-	-	✓	Contact service
Show grinder adjust button	No	-	-	✓	Contact service
Show rinse key	Yes	-	-	✓	Contact service
Show stop key	Yes	-	-	✓	Contact service
Show product prices	Yes	-	-	✓	Contact service
Show product Key symbols	Yes	-	-	✓	Contact service



11.3.4 Beans & Grinder

Parameter	Default	Operator (password protected)	Manager	Tech	See chapter
Grind hopper rear	-	✓	✓	✓	"6.6" on page 72
finer (-) [1/100 mm]	0	✓	✓	✓	"6.6" on page 72
Coarser (+) [1/100 mm]	0	✓	✓	✓	"6.6" on page 72
Grind hopper front	-	✓	✓	✓	"6.6" on page 72
finer (-) [1/100 mm]	0	✓	✓	✓	"6.6" on page 72
Coarser (+) [1/100 mm]	0	✓	✓	✓	"6.6" on page 72

11.3.5 Clean/Standby

Parameter	Default	Operator	Manager	Tech	See chapter
Cleaning Mode	Periodic	-	-	✓	Contact Service
Cleaning Time	18:00	-	-	✓	Contact Service
Cleaning Period [h]	24	-	-	✓	Contact Service
Cleaning Time Tolerance [h]	4	-	-	✓	Contact Service
Cleaning Weekend Mode	off	-	-	✓	Contact Service
If cleaned without detergent	Block never	-	-	✓	Contact Service
Standby After Cleaning	No	-	✓	✓	"6.7" on page 73
Standby On/Off times	off	-	✓	✓	"6.7" on page 73

11.3.6 Password

Parameter	Default	Operator	Manager	Tech	See chapter
Operator	-	-	✓	✓	"6.8" on page 73
- Change password	-	-	✓	✓	"6.8" on page 73
Manager	-	-	✓	✓	"6.8" on page 73
- Change password	-	-	✓	✓	"6.8" on page 73

11.3.7 Other settings and parameters

For all other settings and parameters not listed, please contact your service organisation.

Index

B

Bean hoppers	19, 20, 22
Bean hoppers unlocked	100
Blocked or broken cleaning balls	89, 96
Burning danger	15

C

Coffee outlet	19
Coffee products types	121
Compliance	10
Corrosive product	15
Cups	56
Cups not warm	100

D

Decaf	121
Decaf.	60
Delete All Languages	71
Directives	10
Disposal	14
Drip tray	19

E

Earth	115
Emergency stop	64
EMT	119
Everclean	121
Everclean™	11

Everfoam	121
Eversys cleaning balls	22, 121
Eversys cleaning balls™	11

F

Front view	19
------------------	----

H

Heating panel	56
Hot water product	57

I

Import Icons	71
Import Language	71
Intended Use	9
Irritant products	11

K

Keep safe	11
-----------------	----

L

Layer Page	47
Learn Quantity	69
Login	66



M

Machine type	39
MAD	119
Main switch OFF	15
Main switch ON	15
Manager	119
Manager login	66
Minor injury	120
Moderate injury	120

N

No milk dispensed	100
No water connected	100

O

Ocean	115
Operator	119
Operator login	66
Optional countertop cut out dimensions	103
Order information	23

P

Packaging material	14
Packaging signs	16
Personnel	119
Powder coffee	60
Press and hold	45
Press top	45
Product test	69
Protective earthing	15

R

Rating plate.	39
Refill Eversys cleaning balls	89
Rinse	55
Risk of burns	11
Risk of electrocution	11

S

Safety	
Importance of the instructions	10
Non-compliance with rules	10
Safety data sheets	11
Safety signs	15
Scalding	11

Service engineer	119
Service organization	119
Short-term storage	13
Slide	45
Standby after cleaning	73
Standby On / Off times	73
Steam product	58
Steam wand	19
Steam wand clogged	100
Stop	61
Stop Temperature	69
Switch OFF	63
Switch ON	54

T

Tap	45
Tea outlet	19
Tempest	115

U

User	119
------------	-----

W

Warranty	118
Water inlet	20
Water tap closed	15
Water tap open	15
Water Temperature	69



S U P E R T R A D I T I O N A L 

H E A D Q U A R T E R

EVERSYS S.A.

Ecoparc de Daval A 2

Sierre

Switzerland

+41 27 305 21 21

R E G I O N A L O F F I C E S

EVERSYS ASIA

16/F Tins Enterprise Center

777 Lai Chi Kok Road

Cheung Sha Wan

Hong Kong

EVERSYS INC

545 8th Ave, Suite 540

New York

United States of America

1-888-511-0750

EVERSYS UK & ROI

Operations Centre Unit 8, Stanley

Business Centre, Kelvin Way

Crawley

United Kingdom

+44 20 3960 0503