



SANSONE XP

tirasfoglia pasta roller

- Potente tirasfoglia realizzata in 4 misure
- Realizzazione verticale che riduce l'ingombro sul tavolo da lavoro e agevola la presa della sfoglia in uscita
- Costruzione in acciaio inox
- Motore ventilato a servizio continuo con doppia riduzione
- Riduttore coassiale + trasmissione a catena
- Regolazione spessore pasta 0 ÷ 10 mm
- Protezione zona carico con micro di sicurezza
- Ampio scivolo di carico sfoglia facilmente rimovibile
- Protezione mani in acciaio inox rimovibile per pulizia
- Ideale anche per laminare pizza

Opzionale

- Applicazione taglierina in 5 misure, mm 2 - 4 - 6 - 8 - 12, larghezza mm 165

- *Powerful dough roller available in 4 sizes*
- *Vertical construction that reduces the space taken up on the working counter and facilitates gripping of the dough at outfeed*
- *Built out of stainless steel*
- *Ventilated motor in non-stop operating mode with dual reduction*
- *Coaxial reduction gear + belt transmission*
- *Adjustable dough thickness 0 ÷ 10 mm*
- *Infeed area protected with safety microswitch*
- *Wide chute for dough infeed, easy to remove*
- *Stainless steel hand protection removable for cleaning*
- *Perfect also to laminate pizza*

Optional

- *Application cutter available in 5 sizes, mm 2 - 4 - 6 - 8 - 12, width pasta cutter mm 165*



SANSONE 42





Taglierina opzionale
Optional pasta cutter



SANSONE 32









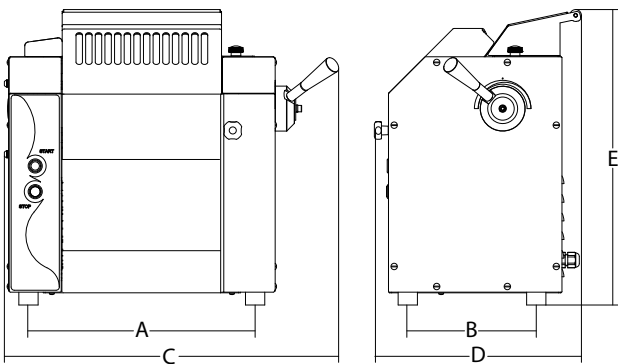



SANSONE 52



SANSONE 25



											
	watt/HP		mm	mm	mm	mm	mm	mm	kg	mm	kg
Sansone 25 XP	270/0.37	1ph	ø 60x250	352	200	515	322	450	47	760x640x800	61
Sansone 32 XP	370/0.5	1ph/3ph	ø 60x320	422	200	600	322	450	53	760x640x800	67
Sansone 42 XP	370/0.5	1ph/3ph	ø 60x420	522	200	700	322	450	62	760x640x800	75
Sansone 52 XP	370/0.5	1ph/3ph	ø 60x520	622	200	800	322	450	69	760x640x800	81